



# Operation **Manual**

## **Goodrive18 Series**

### **Two-in-One VFD**



<b>No.</b>	<b>Change description</b>	<b>Version</b>	<b>Release date</b>
1.	First release	V1.0	October 2019

# Contents

<b>Contents</b> .....	<b>i</b>
<b>1 Safety Precautions</b> .....	<b>1</b>
1.1 Safety definition .....	1
1.2 Warning symbols.....	1
1.3 Safety guidelines.....	2
1.3.1 Delivery and installation .....	2
1.3.2 Commissioning and running.....	3
1.3.3 Maintenance and component replacement .....	3
1.3.4 Disposal of a scrap VFD.....	3
<b>2 Product overview</b> .....	<b>4</b>
2.1 Quick startup .....	4
2.1.1 Unpacking inspection .....	4
2.1.2 Checking before applying.....	4
2.1.3 Environment .....	4
2.1.4 Installation confirmation.....	5
2.1.5 Basic commissioning.....	5
2.2 Product specifications .....	6
2.3 Product nameplate.....	8
2.4 Model designation code .....	8
2.5 Product ratings .....	9
2.6 Structural diagram.....	9
<b>3 Installing</b> .....	<b>11</b>
3.1 Mechanical installation.....	11
3.1.1 Installation environment .....	11
3.1.2 Installation direction.....	12
3.1.3 Installation methods .....	12
3.1.4 Main circuit wiring diagram.....	13
3.1.5 Main circuit terminal diagram .....	14
3.1.6 Wiring the main circuit terminals .....	14
3.1.7 Control circuit wiring diagram.....	15
3.1.8 Control circuit terminal diagram .....	15
3.1.9 Input/output signal connection diagram .....	17
3.2 Wiring protection .....	19
3.2.1 Protecting the VFD and input power cable in short circuit .....	19
3.2.2 Protecting the motor and motor cable .....	19
3.2.3 Bypass connection .....	19
<b>4 Operating</b> .....	<b>21</b>
4.1 Keypad introduction .....	21
4.2 Keypad display.....	23
4.2.1 Displaying stopped-state parameters.....	23
4.2.2 Displaying running-state parameters .....	24
4.2.3 Displaying fault information .....	24
4.2.4 Editing function codes .....	24
4.3 Operations on the keypad .....	25
4.3.1 How to switch between the P and F function groups .....	25
4.3.2 How to modify VFD function codes .....	25

4.3.3	How to set the VFD user password.....	26
4.3.4	Viewing VFD status.....	26
4.3.5	How to copy function parameters.....	27
<b>5</b>	<b>Function parameters and function terminal reuse.....</b>	<b>28</b>
5.1	Function parameter list.....	28
5.2	Function terminal reuse.....	97
<b>6</b>	<b>Troubleshooting.....</b>	<b>98</b>
6.1	Fault prevention.....	98
6.1.1	Periodical maintenance.....	98
6.1.2	Cooling fan.....	101
6.1.3	Capacitor.....	102
6.1.4	Power cable.....	103
6.2	Fault handling.....	104
6.2.1	Alarm and fault indication.....	104
6.2.2	Fault reset.....	104
6.2.3	Faults and solutions.....	104
6.2.4	Other status.....	109
<b>7</b>	<b>Communication.....</b>	<b>110</b>
7.1	Modbus protocol introduction.....	110
7.2	Application to the VFD.....	110
7.2.1	Two-wire RS485.....	111
7.2.2	RTU mode.....	113
7.2.3	ASCII mode.....	117
7.3	Command codes and communication data.....	119
7.3.1	RTU mode.....	119
7.3.2	ASCII mode.....	123
7.4	Data address definition.....	126
7.4.1	Function code address format rules.....	126
7.4.2	Address description of other function codes.....	127
7.4.3	Fieldbus scale.....	131
7.4.4	Error messages.....	132
7.5	Reading and writing examples.....	134
7.5.1	Example of reading command 03H.....	134
7.5.2	Example of writing command 06H.....	135
7.5.3	Example of continuous writing command 10H.....	137
7.6	Common communication faults.....	139
<b>Appendix A</b>	<b>Technical data.....</b>	<b>140</b>
A.1	Derated application.....	140
A.1.1	Capacity.....	140
A.1.2	Derating.....	140
A.2	CE.....	141
A.2.1	CE marking.....	141
A.2.2	EMC compliance declaration.....	141
A.3	EMC regulations.....	141
<b>Appendix B</b>	<b>Dimensional drawing.....</b>	<b>143</b>
<b>Appendix C</b>	<b>Optional peripheral accessories.....</b>	<b>144</b>
C.1	Wiring of peripheral accessories.....	144
C.2	Power supply.....	145
C.3	Cables.....	146

---

C.3.1 Power cables.....	146
C.3.2 Control cables .....	146
C.4 Breaker and electromagnetic contactor .....	148
C.5 Reactors .....	148
C.6 Filters.....	149
C.6.1 C3 filter model .....	149
C.6.2 C3 filter model selection.....	150
<b>Appendix D Further information .....</b>	<b>151</b>
D.1 Product and service queries.....	151
D.2 Feedback on INVT VFD manuals.....	151
D.3 Documents on the Internet .....	151

# 1 Safety Precautions

Read the manual carefully before moving, installing, running and servicing the variable-frequency drive (VFD), and follow all safety precautions contained. Otherwise, device damage or personal injury or even death can result.

We are not liable or responsible for any device damage or personal injury or death caused by you or your customers due to your ignorance of the safety precautions.

## 1.1 Safety definition

**Danger:** Severe personal injury or even death can result if related requirements are not followed.









**Warning:** Personal injury or device damage can result if related requirements are not followed.

**Note:** Actions taken to ensure proper running.





**Qualified electricians:** People working on the device must have received professional electrical and safety training and obtained the certificates, and must be familiar with all steps and requirements of device installing, commissioning, running and maintaining and capable to prevent any emergencies.

## 1.2 Warning symbols

Warnings caution you about conditions that can result in severe injury or death and/or device damage and advice on how to prevent dangers. The following table lists the warning symbols in this manual.

Symbol	Name	Description	Abbreviation
 Danger	Danger	Severe personal injury or even death can result if related requirements are not followed.	
 Warning	Warning	Personal injury or device damage can result if related requirements are not followed.	
 Do not	Electrostatic discharge	PCBA board damage can result if related requirements are not followed.	
 Hot sides	Hot sides	The VFD base may be hot. Do not touch.	
Note	Note	Actions to ensure proper running.	<b>Note</b>

### 1.3 Safety guidelines

	Only trained and qualified electricians can operate on the device. Do not perform any wiring, inspection, or component changing when power is applied. Ensure all input power supplies are disconnected before wiring or checking, and always wait at least the time designated on the VFD or until the DC bus voltage is less than 36V. The following table lists the waiting time.		
	VFD model		Minimum waiting time
	3PH 380V	0.75kW–7.5kW	5 minutes
	Do not refit the VFD unless authorized; otherwise, fire, electric shock or other injuries may result.		
	The heat sink base may become hot during running. Do not touch it; otherwise, burns may result.		
	The electronic components inside the VFD are electrostatic sensitive. Take measurements to avoid electrostatic discharge during related operation.		

#### 1.3.1 Delivery and installation

	<ul style="list-style-type: none"> <li>◇ Install the VFD on fire-retardant material and keep the VFD away from combustible materials.</li> <li>◇ Do not run a damaged or incomplete VFD.</li> <li>◇ Do not touch the VFD with wet items or body parts; otherwise, electric shock may result.</li> </ul>
--	---

- ◇ Select appropriate tools for delivery and installation to ensure proper VFD running and prevent accidents. To ensure physical safety, take mechanical protective measures such as wearing safety shoes and working uniforms.
- ◇ Do not carry the VFD only by its front cover as the cover may fall off.
- ◇ Ensure to avoid physical shock or vibration during delivery and installation.
- ◇ Install the VFD far away from children and other public places.
- ◇ Note that the VFD cannot meet the low voltage protection requirements in IEC61800-5-1 if the installation site altitude exceeds 2000 meters.
- ◇ As leakage current during VFD running may exceed 3.5mA, apply reliable grounding and ensure ground resistance is less than 10Ω. The PE ground conductor and phase conductor have equal conductivity capability. For the models of 30kW or higher, the cross section of the PE ground conductor can be slightly less than the recommended area.
- ◇ R, S, T/L, and N are the power input terminals, while U1/U2, V1/V2, and W1/W2 are output terminals for motors. Connect the input power cables and motor cables properly; otherwise, VFD damage to may result.

### 1.3.2 Commissioning and running

	<ul style="list-style-type: none"> <li>✧ Disconnect all power sources applied to the VFD before terminal wiring, and wait for at least the time designated on the VFD after disconnecting the power sources.</li> <li>✧ High voltage presents inside the VFD during running. Do not carry out any operation on the VFD during running except for keypad setup.</li> <li>✧ The VFD may start up by itself when <a href="#">P01.21</a> (restart after power down) is set to 1. Do not get close to the VFD and motor.</li> <li>✧ The VFD cannot be used as "Emergency-stop device". The VFD can act as an emergency brake for the motor only after being install with a mechanical brake device.</li> </ul>
--	---

Do not switch on or switch off input power sources of the VFD frequently.

For VFDs that have been stored for a long time, set the capacitance and carry out inspection and pilot run on the VFD before use.

Close the front cover before VFD running; otherwise, electric shock may occur.

### 1.3.3 Maintenance and component replacement



	<ul style="list-style-type: none"> <li>✧ Only well-trained and qualified professionals are allowed to perform maintenance, inspection, and component replacement on the VFD.</li> <li>✧ Disconnect all the power sources applied to the VFD before terminal wiring, and wait for at least the time designated on the VFD after disconnecting the power sources.</li> <li>✧ Take measures to prevent screws, cables and other conductive matters from falling into the VFD during maintenance and component replacement.</li> </ul>
--	--

Use proper torque to tighten the screws.

Keep the VFD and its parts and components away from combustible materials during maintenance and component replacement.

Do not carry out insulation voltage-endurance test on the VFD, or measure the control circuits of the VFD with megameter.

### 1.3.4 Disposal of a scrap VFD

	<ul style="list-style-type: none"> <li>✧ The VFD contains heavy metal. Dispose of a scrap VFD as industrial waste.</li> </ul>
	<ul style="list-style-type: none"> <li>✧ When the life cycle ends, the VFD should enter the recycling system. Dispose of it separately at an appropriate collection point instead of placing it in the normal waste stream.</li> </ul>



## 2 Product overview

### 2.1 Quick startup

#### 2.1.1 Unpacking inspection

Check the following after receiving the product.

Whether the packing box is damaged or dampened.
Whether the model identifier on the exterior surface of the packing box is consistent with the purchased model.
Whether the interior surface of the packing box is abnormal, for example, in wet condition, or whether the enclosure of the VFD is damaged or cracked.
Whether the VFD nameplate is consistent with the model identifier on the exterior surface of the packing box.
Whether the accessories (including the manual and keypad) inside the packing box are complete.

If any problems are found, contact the local dealer or INVT office.

#### 2.1.2 Checking before applying

Check the following before applying the VFD.

**Note:** Do not carry out insulation voltage-endurance test on the VFD, or measure the control circuits of the VFD with megameter.

1. Check the load type to verify that there is no overload of the VFD during work and check whether the power class of the VFD needs to be modified.
2. Check whether the actual running current of the motor is less than the rated current of the VFD.
3. Check whether the control accuracy required by the load is the same of the VFD.
4. Check whether the grid voltage is consistent with the rated voltage of the VFD.

#### 2.1.3 Environment

Check the following before the actual installation and use:

1. Check whether the ambient temperature of the VFD exceeds 40°C. If it exceeds 40°C, derate 1% for every increase of 1°C. It is not recommended to use the VFD if the ambient temperature exceeds 50°C. <b>Note:</b> For a cabinet VFD, the ambient temperature is the air temperature inside the cabinet.
2. Check whether the ambient temperature of the VFD in actual use is lower than -10°C. If yes, use heating facilities. <b>Note:</b> For a cabinet VFD, the ambient temperature is the air temperature inside the cabinet.

- |  |
|--|
| 3. When the altitude exceeds 1000m, derate by 1% for every increase of 100m. When the altitude exceeds 2000m, configure an isolation transformer at the VFD input end. It is not recommended that the VFD be used at the altitude higher than 5000m. |
| 4. Check whether the humidity of the actual usage site exceeds 90% and condensation occurs. If yes, take additional protective measures.   |
| 5. Check whether the actual use site may be exposed to direct sunlight or may have the chance of ingress of foreign objects. If yes, take additional protective measures.  |
| 6. Check whether there is dust, explosive gas, or flammable gas in the actual use site. If yes, take additional protective measures.   |

#### 2.1.4 Installation confirmation

Check the following after the VFD installation:

- |   |
|---|
| 1. Check whether the load ranges of the input power cable and motor cable meet the actual load requirement.   |
| 2. Check whether correct accessories are selected for the VFD, the accessories are correctly and properly installed, and the installation cables meet the requirements of all components (including the reactor, input filter, output reactor, output filter, DC reactor, braking unit and braking resistor). |
| 3. Check whether the VFD is installed on non-flammable materials and the heat-radiating accessories (such as the reactor) are away from flammable materials.  |
| 4. Check whether all control cables and power cables are run separately and the routing complies with EMC requirement.  |
| 5. Check whether all grounding systems are properly grounded according to the requirements of the VFD.  |
| 6. Check whether all the installation clearances of the VFD meet the requirements in the operation manual.  |
| 7. Check whether the installation conforms to the instructions in the operation manual. It is recommended that the VFD be installed uprightly.  |
| 8. Check whether the external connection terminals of the VFD are tightly fastened and the torque is appropriate.   |
| 9. Check whether there are screws, cables, or other conductive items left in the VFD. If yes, get them out.   |

#### 2.1.5 Basic commissioning

Complete the basic commissioning as follows before the actual use of the VFD:

- |  |
|--|
| 1. Autotune. If possible, de-couple the VFD from the motor load to start dynamic autotuning. If the VFD cannot be de-coupled from the load, perform static autotuning. |
| 2. Adjust the ACC/DEC time according to the actual work condition of the load.   |
| 3. Perform device commissioning by means of jogging and check whether the motor  |

rotational direction is correct. If not, change the rotation direction by swapping any two phase wires of the motor.

4. Set all control parameters and then operate.

## 2.2 Product specifications

Function		Specifications
Power input	Rated input voltage (V)	For the -4 type: 3PH 380V(-15%)–440V(+10%)
	Rated input current (A)	See "Product ratings".
	Rated frequency	50Hz or 60Hz, allowable range: 47–63Hz
Power output	Rated motor capacity (kW)	See "Product ratings".
	Rated output (kVA)	See "Product ratings".
	Rated current (A)	See "Product ratings".
	Rated output voltage (V)	Equal to the input voltage, with the deviation less than 5%
	Rated output frequency (Hz)	0–400Hz
Technical control performance	Control mode	V/F control and sensorless vector control (SVC)
	Motor type	Asynchronous motor (AM)
	Speed ratio	1:100
	Speed control accuracy	±0.2% (SVC)
	Speed fluctuation	± 0.3% (SVC)
	Torque response	<20ms (SVC)
	Torque control accuracy	10% (SVC)
	Starting torque	0.5Hz 150% (SVC)

Function		Specifications
	Overload capacity	150% for 1min, 180% for 10s, 200% for 1s
Running control performance	Frequency setting method	Settings can be implemented through digital, analog, pulse frequency, multi-step speed running, simple PLC, PID, MODBUS communication, and so on. Settings can be combined and the setting channels can be switched.
	Automatic voltage regulation	The output voltage can be kept constant although the grid voltage changes.
	Fault protection	All-round protection functions, such as protection against overcurrent, overvoltage, undervoltage, overheat, phase loss, and overload.
External interface	Analog input	AI2: 0–10V/0–20mA Whether the output type is voltage or current can be selected through <a href="#">P05.49</a> . AI3: -10V–10V AI2/AI3 min. resolution: 10mV/20mV
	Analog output	1. Output range: AO1/AO2, 0–10V/0–20mA 2. Whether the output type is voltage or current can be selected through the control board jumper. 3. Full range deviation: ±1%, 25°C
	Digital input	Eight common inputs, max. frequency 1kHz
	Relay output	Two programmable relay outputs: RO1A is NO, RO1B is NC, and RO1C is the common terminal. RO2A is NO, RO2B is NC, and RO2C is the common terminal. Contact capacity: 3A/AC250V
Other	Installation method	Wall mounting
	Brake unit	None
	EMI filter	You can choose to use the external filter, meeting IEC61800-3 C3/C2 requirements.
	Temperature of operating environment	-10–50°C. If the temperature exceeds 40°C, derate 1% for every increase of 1°C.

Function		Specifications
	Altitude	When the altitude is higher than 1000m but lower than 3000m, derate 1% for every increase of 100m. When the altitude is higher than 2000m, configure an isolation transformer at the VFD input end. When the altitude is higher than 3000m but lower than 5000m, consult INVT for technical issues. It is not recommended that the VFD be used at the altitude higher than 5000m.
	IP rating	IP20
	Pollution class	Class 2
	Safety requirement	Compliant with CE requirements
	Cooling method	Forced air cooling

### 2.3 Product nameplate

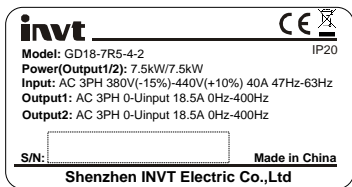

Figure 2.1 Product nameplate

**Note:** This is a nameplate example for a standard Goodrive18 series two-in-one VFD model. The mark such as CE/TUV/IP20 will be applied according to the actual certification situation.

### 2.4 Model designation code

A model designation code contains product information. You can find the model designation code on the VFD nameplate and simplified nameplate.

**GD18 - 7R5 - 4 - 2**

①      ②      ③      ④

Figure 2.2 Model designation code

Field	No.	Description	Example
Abbreviation of product series	①	Abbreviation of product series	GD18: short for Goodrive18
Rated power	②	Power range + load type	7R5: 7.5kW
Voltage class	③	Voltage class	4: AC 3PH 380V(-15%) - 440V(+10%)
Structure	④	Number of devices in the combination	2: Two in one, two inverting outputs

## 2.5 Product ratings

VFD model	Voltage class	Output power (kW)	Input current (A)	Output current (A)
GD18-0R7-4-2	3PH 380V	0.75/0.75	7	2.5/2.5
GD18-1R5-4-2		1.5/1.5	10	4.2/4.2
GD18-2R2-4-2		2.2/2.2	12	5.5/5.5
GD18-004-4-2		4/4	25	9.5/9.5
GD18-5R5-4-2		5.5/5.5	32	14/14
GD18-7R5-4-2		7.5/7.5	40	18.5/18.5

## 2.6 Structural diagram

The VFD structure is shown in the following figure (using the 7.5kW model as an example):

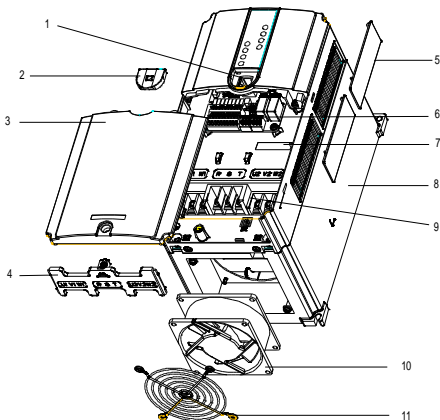



Figure 2.3 Structural diagram

No.	Item	Description
1	External keypad interface	Used to connect an external keypad.
2	External keypad interface cover	Used to protect the external keypad interface.
3	Lower cover	Used to protect the internal components.
4	Junction box	Used to fix the cables of the main and control circuits.
5	Ventilation hole cover	Used to prevent against the ingress of dust or water.
6	Control terminals	See "Installing".
7	Barcode label	Same as the barcode on the nameplate. <b>Note:</b> The barcode identified by 7 is located in the middle of the housing and can be seen after the cover is removed.
8	Nameplate	See "Product nameplate".
9	Main circuit terminals	See "Installing".
10	Cooling fan	See "Troubleshooting".
11	Fan cover	Used to protect the fan.

## 3 Installing

This chapter introduces the mechanical and electrical installations of the VFD.

	<ul style="list-style-type: none"> <li>✧ Only trained and qualified professionals are allowed to carry out the operations mentioned in this chapter. Perform operations following the instructions presented in "Safety precautions". Ignoring the safety precautions may result in device damage or injury or even death.</li> <li>✧ Ensure the VFD power is disconnected before installation. If the VFD has been powered on, disconnect the VFD from the power, and wait at least the time marked on the VFD before carrying out an operation.</li> <li>✧ VFD installation must be designed and performed according to applicable local laws and regulations. INVT is not liable or responsible for any installation that breaches local laws and regulations. If recommendations given by INVT are not followed, the VFD may experience problems that the warranty does not cover.</li> </ul>
--	---

### 3.1 Mechanical installation

#### 3.1.1 Installation environment

The VFD installation environment is essential for the VFD to run with best performance in long terms. Install the VFD in an environment compliant with the following requirements.

Environment	Condition
Installation site	✧ Indoor
Ambient temperature	<ul style="list-style-type: none"> <li>✧ -10—50°C. The air temperature change rate is less than 0.5°C/min.</li> <li>✧ When the ambient temperature exceeds 40°C, derate 1% for every temperature increase of 1°C.</li> <li>✧ It is not recommended that the VFD be used (without load) when the ambient temperature exceeds 50°C.</li> <li>✧ In order to ensure reliability, do not use the VFD in cases where the temperature changes rapidly.</li> <li>✧ When the VFD is used in closed space such as a control cabinet, use the cooling fan or air conditioner to prevent the internal temperature from exceeding the allowed temperature.</li> <li>✧ When the temperature is too low, install an external heating device before running the VFD that has been powered off for a long time, which eliminates the freeze inside the VFD. Otherwise, the VFD may be damaged.</li> </ul>
Humidity	<ul style="list-style-type: none"> <li>✧ The relative humidity (RH) of the air is less than 90%.</li> <li>✧ Condensation is not allowed.</li> </ul>



Environment	Condition
Storage temperature	◇ -40° C – +70° C. The air temperature change rate is less than 1°C/min.
Operating environment	The installation site must be: ◇ Away from electromagnetic radiation sources. ◇ Away from oil mist, corrosive gases and combustible gases. ◇ Protective from foreign materials such as metal powder, dust, oil, and water so that the foreign materials will not fall into the VFD. (Do not install the VFD on inflammables such as wood.) ◇ Away from radioactive substances and combustible objects. ◇ Away from harmful gases and liquids. ◇ With a low salt content density. ◇ No direct sunlight.
Altitude	◇ When the altitude is higher than 1000m but lower than 3000m, derate by 1% for every increase of 100m. ◇ When the altitude is higher than 2000m, configure an isolation transformer at the VFD input end. ◇ When the altitude is higher than 3000m but lower than 5000m, consult INVT for technical issues. ◇ It is not recommended that the VFD be used at the altitude higher than 5000m.
Vibration	◇ The max. vibration amplitude cannot exceed 5.8m/s <sup>2</sup> (0.6g).
Installation direction	◇ Install the VFD vertically to ensure good heat dissipation effect.

**Note:**

- The VFD needs to be installed in a clean and well-ventilated environment based on the IP rating of the VFD housing.
- The cooling air must be clean enough and free from corrosive gases and conductive dust.

**3.1.2 Installation direction**

The VFD can be installed on the wall or in a cabinet.

The VFD must be installed vertically. Check the installation position according to following requirements. For details about outline dimensions, see Appendix B "Dimensional drawing".

**3.1.3 Installation method**

Goodrive18 series 2-in-1 VFD supports wall mounting.

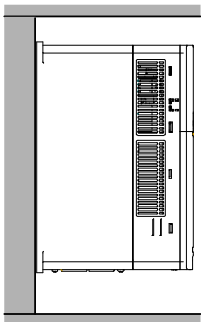

Figure 3.1 Installation method

Step 1 Mark the positions of the installation holes. For details about the positions, see Appendix B "Dimensional drawing".

Step 2 Mount the screws or bolts onto the marked positions.

Step 3 Place the VFD against the wall.

Step 4 Fasten the screws on the wall.

### 3.1.4 Main circuit wiring diagram

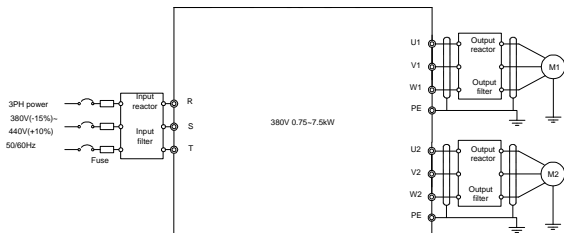

Figure 3.2 Main circuit wiring diagram

**Note:** The fuse, input reactor, input filter, output reactor, and output filter are optional parts. For details, see Appendix C "Optional peripheral accessories".

### 3.1.5 Main circuit terminal diagram

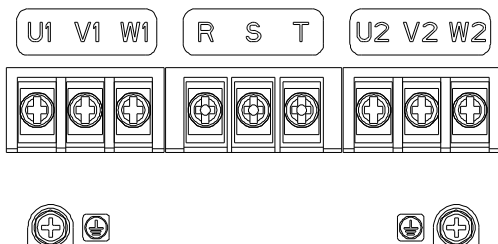



Figure 3.3 Main circuit terminal diagram

Terminal sign	Terminal function
R, S, T	3PH AC input terminals, connected to the grid
U1, V1, W1	First channel of 3PH AC output terminal, connected to the motor in most cases
U2, V2, W2	Second channel of 3PH AC output terminal, connected to the motor in most cases
	Protective earthing (PE) terminal for safe protection; each device must be properly grounded.

#### Note:

- Do not use asymmetrical motor cables. If there is a symmetrical grounding conductor in the motor cable besides the conductive shielded layer, ground the grounding conductor on the VFD end and motor end.
- Route the motor cable, input power cable and control cables separately.

### 3.1.6 Wiring the main circuit terminals

Step 1 Connect the grounding line of the input power cable to the PE terminal of the VFD, connect the 3PH input cable to the R, S and T terminals of the VFD, and tighten up.

Step 2 Connect the grounding line of the motor cable to the PE terminal of the VFD, connect the 3PH cable of the motor to the U1/U2, V1/V2, and W1/W2 terminals of the VFD, and tighten up.

Step 3 If allowed, fix all the cables at the outside of the VFD mechanically.

## 3.1.7 Control circuit wiring diagram

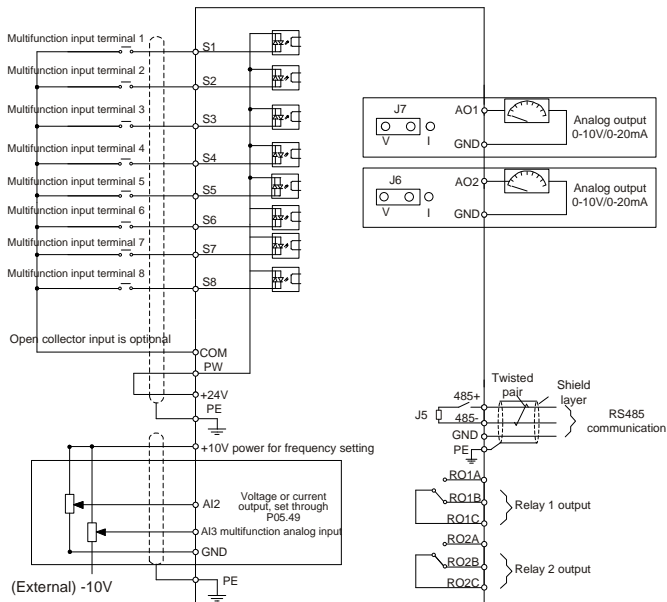

Figure 3.4 Control circuit wiring diagram

## 3.1.8 Control circuit terminal diagram

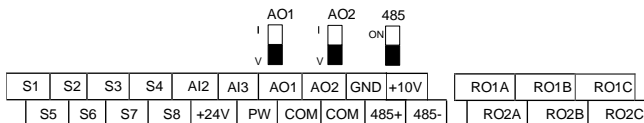

Figure 3.5 Control circuit terminal diagram

Category	Sign	Assigned by default	Function	Specifications
Communication	485+ 485-	Shared	RS485 communication	RS485 communication terminals, using the MODBUS protocol
Digital input/output	S1	#1 Inverter unit	Digital input	<ul style="list-style-type: none"> <li>● Internal impedance: 3.3kΩ</li> <li>● 12–30V voltage input is acceptable</li> <li>● Bi-direction input terminals</li> <li>● Max. input frequency: 1kHz</li> </ul>
	S2			
	S3			
	S4			
	S5	#2 Inverter unit		
	S6			
	S7			
	S8			
	PW	Shared	Digital power supply	Used to provide the working power supply for digital from the external Voltage range: 12 - 30V
	COM			Common terminal of open collector output
24V power supply	+24V  COM	Shared	24V power supply	Used to provide the 24V±10% power supply for the external. Max. output current: 200mA Generally used as the digital input/output working power supply or externally connected to the sensor power supply
Analog input/output	+10V	Shared	External 10V reference power supply	10V reference power supply. Max. output current: 50mA Generally used as the adjusting power supply of the external potentiometer with the resistance of higher than 5kΩ
	AI2	#1 Inverter unit	Analog input	<ul style="list-style-type: none"> <li>● Input range: For AI2, 0–10V or 0–20mA. For AI3, -10V–+10V</li> <li>● Input impedance: 20kΩ for voltage input or 500Ω for current input</li> <li>● Whether AI2 uses voltage or current as input is set through <a href="#">P05.49</a>.</li> <li>● Resolution: 10mV/20mV for AI2/AI3 when 10V corresponds to 50Hz</li> </ul>
	AI3	#2 Inverter unit		

Category	Sign	Assigned by default	Function	Specifications
	GND	Shared	Analog reference ground	Analog reference ground
	AO1	#1 Inverter unit	Analog output	<ul style="list-style-type: none"> <li>● Output range: 0–10V or 0–20mA</li> <li>● Whether the terminals use voltage or current as output is set through the dial switch.</li> <li>● Full range deviation: <math>\pm 1\%</math>, 25°C</li> </ul>
	AO2	#2 Inverter unit		
Relay output	RO1A	#1 Inverter unit	NO contact of relay 1	<ul style="list-style-type: none"> <li>● RO1 output: RO1A is NO, RO1B is NC, and RO1C is the common terminal.</li> <li>● RO2 output: RO2A is NO, RO2B is NC, and RO2C is the common terminal.</li> <li>● Contact capacity: 3A/AC250V</li> </ul>
	RO1B		NC contact of relay 1	
	RO1C		Common terminal of relay 1	
	RO2A	#2 Inverter unit	NO contact of relay 2	
	RO2B		NC contact of relay 2	
	RO2C		Common terminal of relay 2	

### 3.1.9 Input/output signal connection diagram

Please use the jumper to set the NPN mode or PNP mode and select the internal or external power supply. The default setting is the NPN internal mode. The 22AWG wire diameter is recommended for external wiring.

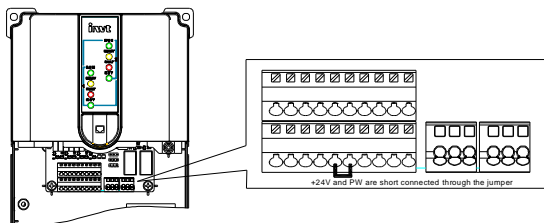

Figure 3.6 Jumper based short connection

If the input signal comes from NPN transistor, set the jumper according to the used power supply.

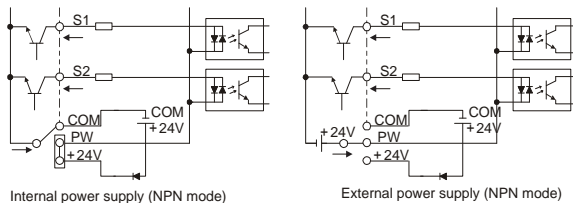

Figure 3.7 NPN mode

If the input signal comes from PNP transistor, set the jumper according to the used power supply.

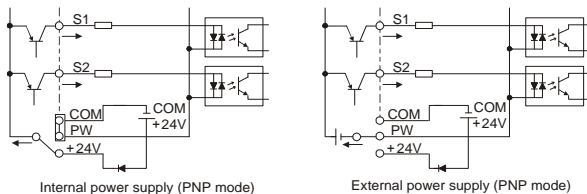

Figure 3.8 PNP mode

## 3.2 Wiring protection

### 3.2.1 Protecting the VFD and input power cable in short circuit

In case of short circuit, the VFD and input power cable can be protected, preventing thermal overload.

Take protective measures according to the following rule.

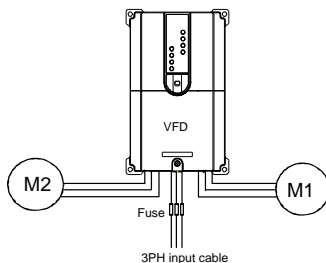



Figure 3.9 Fuse configuration diagram

**Note:** Select the fuse according to Appendix C.4 "Breaker and electromagnetic contactor". In case of short circuit, the fuse protects the input power cable, preventing the VFD from being damaged. When an internal short circuit occurred to the VFD, adjacent equipment is prevented from being damaged.

### 3.2.2 Protecting the motor and motor cable

The VFD protects the motor and motor cable in a short-circuit situation if the motor cable is selected according to the VFD rated current. The VFD provides the motor overload protection function, which can protect the motor and block output and cut off current when necessary.

	<p>⚡ If the VFD is connected to multiple motors, an additional separate thermal overload switch or breaker must be used to protect the motor and motor cable. Such a device may use the fuse to cut off the short-circuit current.</p>
--	--

### 3.2.3 Bypass connection

In critical occasions, setting the power-variable frequency conversion circuit is necessary to ensure proper running even when a VFD fault occurs. In some special scenarios, for example, when only soft startup is needed, power-frequency running can be directly used after soft startup, which requires bypass configuration.





- ⚡ Do not connect the power supply to VFD output terminals U1, V1, W1, U2, V2, and W2. The voltage applied to the motor cable may cause permanent damage to the VFD.

If frequent switchover is needed, you can use the switch/contactors that carry mechanical interlock to ensure motor terminals are not connected to both the input power cable and VFD output end simultaneously.

## 4 Operating

### 4.1 Keypad introduction

Goodrive18 series two-in-one VFD does not provide a keypad but contains eight indicators, as shown in Figure 4.1. You need to use an external keypad (optional part) for parameter commissioning and use a standard RJ45 network cable to connect the external keypad to the VFD.

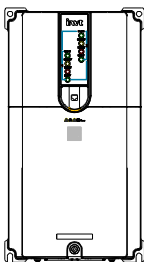

Figure 4.1 Indicators

Indicator	Represents	Description
RUN1	#1 Inverter unit	Running status indicator. On: The inverter unit is running. Off: The inverter unit is stopped.
RUN2	#2 Inverter unit	
READY1	#1 Inverter unit	Ready-to-run indicator. On: The inverter unit is ready to run. Off: The inverter unit is running.
READY2	#2 Inverter unit	
FAULT1	#1 Inverter unit	Fault indicator. On: The inverter unit is in fault state. Off: The inverter unit is in normal state Blinking: The inverter unit is in pre-alarm state.
FAULT2	#2 Inverter unit	
KEY1	#1 Inverter unit	Operation object indicator, identifying which inverter unit the external keypad works on. KEY1 on but KEY2 off: The keypad works on #1 inverter unit. KEY1 off but KEY2 on: The keypad works on #2 inverter unit.
KEY2	#2 Inverter unit	

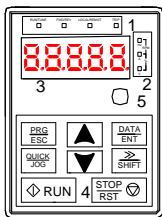









Figure 4.2 External keypad diagram

No.	Item	Description		
1	Status indicator	<b>RUN/TUNE</b>	VFD running status indicator. On: The VFD is running. Off: The VFD is stopped. Blinking: The VFD is autotuning parameters.	
		<b>FWD/REV</b>	Forward or reverse running indicator. On: The VFD is running reversely. Off: The VFD is running forward.	
		<b>LOCAL/REMOT</b>	Indicates whether the VFD is controlled through the keypad, terminals, or communication. On: The VFD is controlled through remote communication. Off: The VFD is controlled through the keypad. Blinking: The VFD is controlled through terminals.	
		<b>TRIP</b>	Fault indicator. On: in fault state Off: in normal state Blinking: in pre-alarm state	
2	Unit indicator	Unit displayed currently		
			Hz	Frequency unit
			RPM	Rotational speed unit
			A	Current unit
			%	Percentage
	V	Voltage unit		
3	Digital display zone	Five-digit LED displays various monitoring data and alarm codes such as the set frequency and output frequency.		

No.	Item	Description	
4	Keys		Programming key Press it to enter or exit level-1 menus or delete a parameter.
			Confirmation key Press it to enter menus in cascading mode or confirm the setting of a parameter.
			UP key Press it to increase data or move upward.
			DOWN key Press it to decrease data or move downward.
			Right-shifting key Press it to select display parameters rightward in the interface for the device in stopped or running state or to select digits to change during parameter setting.
			Run key Press it to run the device when using the keypad for control.
			Stop/Reset key Press it to stop the device that is running. The function of this key is restricted by <a href="#">P07.04</a> . In fault alarm state, this key can be used for reset in any control modes.
			Multifunction shortcut key The function is determined by <a href="#">P07.02</a> .
5	Analog potentiometer	Not supported	

## 4.2 Keypad display

The external keypad for operating Goodrive18 series two-in-one VFD displays the stopped-state parameters, running-state parameters, function parameter editing status, and fault alarm status. Goodrive18 series two-in-one VFD has two channels of inverting output, which are distinguished by the prefix letters P/F. Function codes in group P correspond to the output (U1/V1/W1) of #1 inverter unit, while function codes in group F correspond to the output (U2/V2/W2) of #2 inverter unit. The setting methods of the two groups of function code are the same. The following describes only the function codes in group P.

### 4.2.1 Displaying stopped-state parameters

When the VFD is in stopped state, the keypad displays stopped-state parameters.

In the stopped state, various kinds of parameters can be displayed. You can determine which parameters are displayed by setting the binary bits of [P07.07](#). For definitions of the bits, see the description of [P07.07](#).

In stopped state, there are 15 parameters that can be selected for display, including set

frequency, bus voltage, input terminal status, output terminal status, PID reference value, PID feedback value, torque setting, AI2, AI3, PLC and the current step of multi-step speed, pulse counting value, and length value. You can press **>>/SHIFT** to shift selected parameters from left to right or press **QUICK/JOG** (P07.02=2) to shift selected parameters from right to left.

#### 4.2.2 Displaying running-state parameters

After receiving a valid running command, the VFD enters the running state, and the keypad display running-state parameters, with the **RUN/TUNE** indicator on. The on/off state of the **FWD/REV** indicator is determined by the current running direction.

In running state, there are 24 parameters that can be selected for display, including running frequency, set frequency, bus voltage, output voltage, output current, running speed, output power, output torque, PID reference value, PID feedback value, input terminal status, output terminal status, torque setting, length value, PLC and the current step of multi-step speed, AI2, AI3, motor overload percentage, VFD overload percentage, ramp reference value, linear speed, and AC input current. You can determine which parameters are displayed by setting the binary bits of [P07.05](#) and [P07.06](#). You can press **>>/SHIFT** to shift selected parameters from left to right or press **QUICK/JOG** (P07.02=2) to shift selected parameters from right to left.

#### 4.2.3 Displaying fault information

After detecting a fault signal, the VFD enters the fault alarm state immediately, the fault code blinks on the keypad, and the **TRIP** indicator is on. You can perform fault reset by using the **STOP/RST** key, control terminals, or communication commands.

If the fault persists, the fault code is continuously displayed.

#### 4.2.4 Editing function codes

You can press the **PRG/ESC** key to enter the editing mode in stopped, running, or fault alarm state (if a user password is used, see the description of [P07.00](#)). The editing mode contains two levels of menus in the following sequence: Function code group or function code number → Function parameter. You can press the **DATA/ENT** key to enter the function parameter display interface. On the function parameter display interface, you can press the **DATA/ENT** key to save parameter settings or press the **PRG/ESC** key to exit the parameter display interface.



Figure 4.3 Status display

## 4.3 Operations on the keypad

### 4.3.1 How to switch between the P and F function groups

You can switch between the P function group and F function group by using either of the following methods:

Method 1: Using the combined keys: **PRG/ESC** + **>>/SHIFT**

Method 2: Setting function codes. Change the setting of P14.10 from 0 to 1, or change the setting of F14.10 from 1 to 0.

Note: When the keypad displays Cnt-P or Cnt-F, the switchover to the required inverter unit function group is successful, and the corresponding indicator turns on. For example, if you want to switch from group P to group F, the keypad displays Cnt-F during the switchover and displays function codes in group F within 1 second, and the indicator KEY1 turns off while the indicator KEY2 turns on.

### 4.3.2 How to modify VFD function codes

The VFD provides three levels of menus, including:

- Function code group number (level-1 menu)
- Function code number (level-2 menu)
- Function code setting (level-3 menu)

**Note:** When performing operations on the level-3 menu, you can press the **PRG/ESC** or **DATA/ENT** key to return to the level-2 menu. If you press the **DATA/ENT** key, the set value of the parameter is saved to the control board first, and then the level-2 menu is returned, displaying the next function code. If you press the **PRG/ESC** key, the level-2 menu is returned directly, without saving the set value of the parameter, and the current function code is displayed.

If you enter the level-3 menu but the parameter does not have a digit blinking, the parameter cannot be modified due to either of the following reasons:

- It is read only. Read-only parameters include actual detection parameters and running record parameters.
- It cannot be modified in running state and can be modified only in stopped state.

Example: Change the value of [P00.01](#) from 0 to 1.

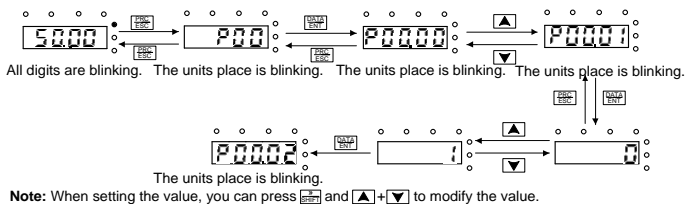

Figure 4.4 Modifying a parameter

### 4.3.3 How to set the VFD user password

Goodrive18 series two-in-one VFD provides the user password protection function. When you set [P07.00](#) to a non-zero value, the value is the user password. After you exit the function code editing interface, the password protection function is enabled within 1 minute. If password protection is enabled, "0.0.0.0.0" is displayed when you press the key again to enter the function code editing interface. You need to enter the correct user password to enter the interface.

To disable the password protection function, you need only to set [P07.00](#) to 0.

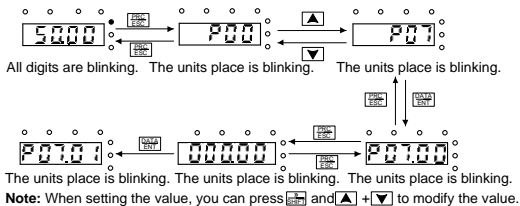
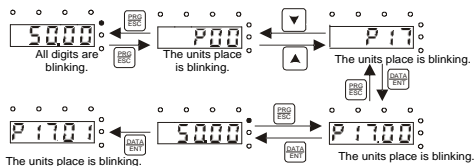

Figure 4.5 Setting a password

### 4.3.4 Viewing VFD status

Goodrive18 series two-in-one VFD provides group P17 for status viewing. You can enter group P17 for viewing.



**Note:** When setting the value, you can press and + to modify the value.

Figure 4.6 Viewing parameter setting

### 4.3.5 How to copy function parameters

The external keypad for operating Goodrive18 series two-in-one VFD supports common parameter copying and embedded parameter copying. The embedded parameter copying function means that the keypad housing contains the icon and parameters can be uploaded and downloaded after P07.01 is set. A common keypad does not have this icon.

Before using the parameter copying function, copy local function parameters to the EEPROM of the keypad. Then the parameters can be downloaded to another VFD.

To upload parameters, set P07.01 to 1, and press DATA. The keypad displays "-UP--" in blinking way, indicating the VFD parameters are being uploaded to the keypad. After the upload is completed, the keypad displays P07.01.

To download parameters:

If all function parameters need to be downloaded, set P07.01 to 2 and press DATA. The keypad displays "-dn1-" in blinking way, indicating the parameters saved on the keypad are being downloaded to the VFD. After the upload is completed, the keypad displays P07.01.

If function parameters excluding parameters in P02 and P12 need to be downloaded or only parameters in P02 and P12 need to be downloaded, set P07.01 to 3 or 4. The keypad displays "-dn2-" or "-dn3-" in blinking way.



## 5 Function parameters and function terminal reuse

### 5.1 Function parameter list

The function parameters of Goodrive18 series two-in-one VFD are divided into 30 groups (P00–P29) by function, and each function group includes several function codes (each function code identifies a function parameter). A three-level menu style is applied to function codes. For example, "[P08.08](#)" indicates the 8th function code in the P00 group. The P29 group indicates factory function parameters, which are user inaccessible.

The function group numbers correspond to the level-1 menus, the function codes correspond to the level-2 menus, and the function parameters correspond to the level-3 menus.

1. The content of the function code table is as follows:

Column 1 "Function code ": Code of the function group and parameter

Column 2 "Name": Full name of the function parameter

Column 3 "Description": Detailed description of the function parameter

Column 4 " Default value": Initial value set in factory

Column 5 " Modify": Whether the function parameter can be modified, and conditions for the modification

"○" indicates that the value of the parameter can be modified when the VFD is in stopped or running state.

"⊙" indicates that the value of the parameter cannot be modified when the VFD is in running state.

"●" indicates that the value of the parameter is detected and recorded, and cannot be modified.

(The VFD automatically checks and constrains the modification of parameters, which helps prevent incorrect modifications.)

2. The parameters adopt the decimal system (DEC). If the hexadecimal system is adopted, all bits are mutually independent on data during parameter editing, and the setting ranges at some bits can be hexadecimal (0–F).

3. "Default value" indicates the factory setting of the function parameter. If the value of the parameter is detected or recorded, the value cannot be restored to the factory setting.

4. To better protect parameters, the VFD provides the password protection function. After a password is set (that is, [P07.00](#) is set to a non-zero value), "0.0.0.0.0" is displayed when you press the **PRG/ESC** key to enter the function code editing interface. You need to enter the correct user password to enter the interface. For the factory parameters, you need to enter the

correct factory password to enter the interface. (You are not advised to modify the factory parameters. Incorrect parameter setting may cause operation exceptions or even damage to the VFD.) When password protection does not take effect, you can change the password any time. When [P07.00](#) is set to 0, no user password is used. When [P07.00](#) is set to a non-zero value during VFD power-on, parameters are prevented from being modified by using the user password function. When you modify function parameters through serial communication, the user password protection function is also applicant and compliant with the same rule.

The function codes in the two groups P and F are the same. The following describes only the function codes in group P.

Function code	Name	Description	Default value	Modify
<b>P00 Basic function group</b>				
P00.00	Speed control mode	0: SVC mode 0 No need to install encoders. Suitable in applications which need low frequency, big torque for high accuracy of rotating speed and torque control. Relative to mode 1, it is more suitable for the applications which need small power. 1: SVC mode 1 Suitable in high performance cases with the advantage of high accuracy of rotating speed and torque. It does not need to install a pulse encoder. 2: SVPWM control mode Suitable in applications which do not need high control accuracy, such as the load of fan and pump. One VFD can drive multiple motors. <b>Note:</b> Before using a vector control mode, enable the VFD to perform motor parameter autotuning first.	2	◎
P00.01	Channel of running commands	This parameter is used to select the channel of running commands for the VFD. The control commands of the VFD includes: start, stop, forward/reverse rotating, jogging and fault reset. 0: Keypad (LOCAL/REMOT off)	0	○

Function code	Name	Description	Default value	Modify
		<p>Carry out command control by using <b>[RUN]</b> or <b>[STOP/RST]</b> on the keypad. When the multifunction key <b>[QUICK/JOG]</b> is set to <b>[FWD/REVC]</b> shifting function (<b>P07.02=3</b>), the key can be used to change the running direction. You can press <b>[RUN]</b> and <b>[STOP/RST]</b> simultaneously in running state to make the VFD coast to stop.</p> <p>1: Terminal (<b>[LOCAL/REMOT]</b> blinking) Carry out command control by using multifunction input terminals.</p> <p>2: Communication (<b>[LOCAL/REMOT]</b> on) Running commands are controlled by the upper monitor through communication</p>		
P00.03	Max. output frequency	<p>This parameter is used to set the maximum output frequency of the VFD. Pay attention to this parameter because it is the foundation of the frequency setting and the speed of acceleration and deceleration.</p> <p>Setting range: <b>P00.04</b>–400.00Hz</p>	50.00Hz	⊙
P00.04	Upper limit of running frequency	<p>The upper limit of the running frequency is the upper limit of the output frequency of the VFD, which is lower than or equal to the maximum output frequency.</p> <p>When the set frequency is higher than the upper limit of the running frequency, the upper limit of the running frequency is used for running.</p> <p>Setting range: <b>P00.05</b>–<b>P00.03</b> (Max. output frequency)</p>	50.00Hz	⊙
P00.05	Lower limit of running frequency	<p>The lower limit of the running frequency is the lower limit of the output frequency of the VFD. When the set frequency is lower than the lower limit of the running frequency, the lower limit of the running frequency is used for running.</p> <p><b>Note:</b> Max. output frequency ≥ Upper limit of frequency ≥ Lower limit of frequency</p> <p>Setting range: 0.00Hz–<b>P00.04</b> (Upper limit of</p>	0.00Hz	⊙

Function code	Name	Description	Default value	Modify
		running frequency)		
P00.06	Setting channel of A frequency command	<p><b>Note:</b> A frequency and B frequency cannot use the same frequency given method. The frequency source can be set by <a href="#">P00.09</a>.</p>	0	○
P00.07	Setting channel of B frequency command	<p>0: Keypad Modify the value <a href="#">P00.10</a> (frequency set by keypad) to modify the frequency by the keypad.</p> <p>1: Reserved</p> <p>2: Analog AI2 setting (corresponding terminal AI2)</p> <p>3: Analog AI3 setting (corresponding terminal AI3)</p> <p>Set the frequency by analog input terminals. Goodrive18 series VFD provides 3 channels of analog input terminal as the standard configuration, of which AI2 can select voltage or current (0–10V/0–20mA) by jumper; while AI3 is voltage input (-10V–+10V).</p> <p><b>Note:</b> When AI2 selects 0–20mA input, the corresponding voltage of 20mA is 10V.</p> <p>100.0% of the analog input setting corresponds to the maximum output frequency (<a href="#">P00.03</a>) in forward direction and -100.0% corresponds to the maximum output frequency (<a href="#">P00.03</a>) in reverse direction.</p> <p>4: Reserved</p> <p>5: Simple PLC program The VFD runs at simple PLC program mode when <a href="#">P00.06</a>=5 or <a href="#">P00.07</a>=5. Set P10 (simple PLC and multi-step speed control) to select the running frequency, running direction, ACC/DEC time and the keeping time of corresponding stage. See the function description of P10 for detailed information.</p> <p>6: Multi-step speed running The VFD runs at multi-step speed mode when <a href="#">P00.06</a>=6 or <a href="#">P00.07</a>=6. Set P05 to select the</p>	2	○

Function code	Name	Description	Default value	Modify
		<p>current running stage, and set P10 to select the current running frequency.</p> <p>The multi-step speed has the priority when <a href="#">P00.06</a> or <a href="#">P00.07</a> is not equal to 6, but the steps can only be steps 1–15. The steps are 0–15 when P00.06 or P00.07 is 6.</p> <p>7: PID control</p> <p>The running mode of the VFD is process PID control when <a href="#">P00.06</a>=7 or <a href="#">P00.07</a>=7. It is necessary to set P09. The running frequency of the VFD is the frequency value after PID acts. See P09 for the detailed information of the given source, given value, feedback source of PID.</p> <p>8: Modbus communication</p> <p>The frequency is set by MODBUS communication. See P14 for detailed information.</p> <p>9 - 11: Reserved</p>		
P00.08	B frequency command reference selection	<p>0: Max. output frequency. 100% of B frequency setting corresponds to the maximum output frequency.</p> <p>1: A frequency command. 100% of B frequency setting corresponds to the maximum output frequency. Select this setting if it needs to adjust on the base of A frequency command.</p>	0	○
P00.09	Combination mode of setting channels	<p>0: A, the current frequency setting is A frequency command</p> <p>1: B, the current frequency setting is B frequency command</p> <p>2: A+B, the current frequency setting is A frequency command + B frequency command</p> <p>3: A-B, the current frequency setting is A frequency command - B frequency command</p> <p>4: Max(A, B): The bigger one between A frequency command and B frequency is the set frequency.</p> <p>5: Min (A, B): The smaller one between A</p>	0	○

Function code	Name	Description	Default value	Modify
		frequency command and B frequency is the set frequency. Note: The combination mode can be shifted by P05 (terminal function).		
P00.10	Frequency set through keypad	When A and B frequency commands select the keypad for setting, the value of the function code is the original setting one of the frequency data of the VFD. Setting range: 0.00 Hz– <a href="#">P00.03</a> (Max. output frequency)	50.00Hz	<input type="radio"/>
P00.11	ACC time 1	ACC time means the time needed if the VFD speeds up from 0Hz to the max. output frequency ( <a href="#">P00.03</a> ).	Model dependent	<input type="radio"/>
P00.12	DEC time 1	DEC time means the time needed if the VFD speeds down from the max. output frequency ( <a href="#">P00.03</a> ) to 0Hz. Goodrive18 series VFD has four groups of ACC/DEC time, which can be selected by P05. The factory default ACC/DEC time of the VFD is the first group. Setting range of <a href="#">P00.11</a> and <a href="#">P00.12</a> : 0.0–3600.0s	Model dependent	<input type="radio"/>
P00.13	Running direction	0: Run at the default direction. The VFD runs in the forward direction. <b>FWD/REV</b> indicator is off. 1: Run at the opposite direction. The VFD runs in the reverse direction. <b>FWD/REV</b> indicator is on. Modify the function code to shift the rotation direction of the motor. This effect equals to the shifting the rotation direction by adjusting either two of the motor lines (U, V and W). The motor rotation direction can be changed by <b>QUICK/JOG</b> on the keypad. Refer to parameter <a href="#">P07.02</a> . <b>Note:</b> When the function parameter is restored to the default value, the motor's running direction is restored to the default one. Use this function	0	<input type="radio"/>

Function code	Name	Description	Default value	Modify																				
		with caution if the change of rotation direction is disallowed after commissioning. 2: Forbid to run in reverse direction: It can be used in some special cases if the reverse running is disallowed.																						
P00.14	Carrier frequency	<table border="1"> <thead> <tr> <th>Carrier frequency</th> <th>Electromagnetic noise</th> <th>Noise and leakage current</th> <th>Heating eliminating</th> </tr> </thead> <tbody> <tr> <td>1kHz</td> <td style="text-align: center;">↑ High</td> <td style="text-align: center;">↑ Low</td> <td style="text-align: center;">↑ Low</td> </tr> <tr> <td>10kHz</td> <td style="text-align: center;">↓ Low</td> <td style="text-align: center;">↓ High</td> <td style="text-align: center;">↓ High</td> </tr> <tr> <td>15kHz</td> <td style="text-align: center;">↓ Low</td> <td style="text-align: center;">↓ High</td> <td style="text-align: center;">↓ High</td> </tr> </tbody> </table> <p>The relationship table of the motor type and carrier frequency:</p> <table border="1"> <thead> <tr> <th>Model</th> <th>Default carrier frequency</th> </tr> </thead> <tbody> <tr> <td>0.75–7.5kW</td> <td>4kHz</td> </tr> </tbody> </table> <p>Advantage of high carrier frequency: ideal current waveform, little current harmonic wave and motor noise. Disadvantage of high carrier frequency: increasing the switch loss, increasing VFD temperature and the impact to the output capacity. The VFD needs to derate on high carrier frequency. At the same time, the leakage and electrical magnetic interference will increase. Applying low carrier frequency is contrary to the above, too low carrier frequency will cause unstable running, torque decreasing and surge. We have set a proper carrier frequency when the VFD is in factory. In general, you do not need to change the parameter. When the frequency used exceeds the default carrier frequency, the VFD needs to derate by</p>	Carrier frequency	Electromagnetic noise	Noise and leakage current	Heating eliminating	1kHz	↑ High	↑ Low	↑ Low	10kHz	↓ Low	↓ High	↓ High	15kHz	↓ Low	↓ High	↓ High	Model	Default carrier frequency	0.75–7.5kW	4kHz	Model depended	○
Carrier frequency	Electromagnetic noise	Noise and leakage current	Heating eliminating																					
1kHz	↑ High	↑ Low	↑ Low																					
10kHz	↓ Low	↓ High	↓ High																					
15kHz	↓ Low	↓ High	↓ High																					
Model	Default carrier frequency																							
0.75–7.5kW	4kHz																							

Function code	Name	Description	Default value	Modify
		10% for each increase of 1k carrier frequency. Setting range: 1.0–15.0kHz		
P00.15	Motor parameter autotuning	0: No operation 1: Rotary autotuning Comprehensive motor parameter autotune It is recommended to use rotating autotuning when high control accuracy is needed. 2: Static autotuning 1 (autotune totally). It is suitable in the cases when the motor cannot be de-coupled from the load. 3: Static autotuning 2 (autotune some parameters only including <a href="#">P02.06</a> , <a href="#">P02.07</a> , and <a href="#">P02.08</a> ).	0	☉
P00.16	AVR function selection	0: Invalid 1: Valid during the whole procedure The auto-adjusting function of the VFD can eliminate the impact on the output voltage of the VFD because of the bus voltage fluctuation.	1	○
P00.18	Function parameter restoration	0: No operation 1: Restore to default values 2: Clear fault records 3: Lock all function codes 4: Apply the music fountain function <b>Note:</b> The function code is restored to 0 after finishing the selected function operation. Use this function with caution since restoring to default values will clear the user password.	0	☉
<b>P01 Start and stop control</b>				
P01.00	Start mode	0: Direct start. Start at the starting frequency <a href="#">P01.01</a> . 1: Start after DC braking. Start the motor at the starting frequency after DC braking (setting the parameter <a href="#">P01.03</a> and <a href="#">P01.04</a> ). It is suitable in the cases where reverse rotation may occur to the low inertia load during starting. 2: Reserved 3: Reserved	0	☉

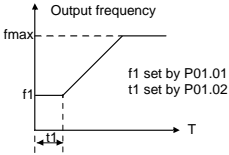

Function code	Name	Description	Default value	Modify
P01.01	Starting frequency at direct start	This function code indicates the initial frequency during VFD start. See <a href="#">P01.02</a> for detailed information. Setting range: 0.00–50.00Hz	0.50Hz	☉
P01.02	Starting frequency hold time	Setting a proper starting frequency can increase the torque during VFD start. During the retention time of the starting frequency, the output frequency of the VFD is the starting frequency. And then, the VFD will run from the starting frequency to the set frequency. If the set frequency is lower than the starting frequency, the VFD will stop running and keep in the standby state. The starting frequency is not limited in the lower limit frequency.  Setting range: 0.0–50.0s	0.0s	☉
P01.03	Braking current before start	The VFD will carry out DC braking at the braking current before start and it will speed up after the DC braking time. If the DC braking time is set to 0, the DC braking is invalid.	0.0%	☉
P01.04	Braking time before start	Stronger braking current indicates larger braking power. The DC braking current before start is a percentage of the rated current peak of the VFD. Setting range of <a href="#">P01.03</a> : 0.0–100.0% (VFD rated current peak) Setting range of <a href="#">P01.04</a> : 0.00–50.00s	0.00s	☉
P01.05	ACC and DEC mode	This function code indicates the changing mode of the frequency during start and running. (t1= <a href="#">P01.06</a> , t2= <a href="#">P01.07</a> ) 0: Linear type The output frequency increases or decreases	0	☉

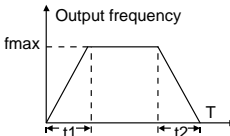
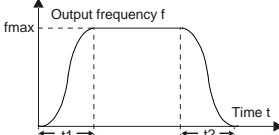
Function code	Name	Description	Default value	Modify
		<p>linearly.</p>  <p>1: S curve The output frequency increases or decreases according to the S curve.</p>  <p>The S curve is generally applied to elevators, conveyors, and other application scenarios where smoother start or stop is required.</p>		
P01.06	ACC time at the S-curve start phase	Setting range: 0.0–50.0s	0.1s	☉
P01.07	DEC time at the S-curve end phase	<b>Note:</b> Valid when <a href="#">P01.05</a> is set to 1.	0.1s	☉
P01.08	Stop mode	<p>0: Decelerate to stop. After the stop command becomes valid, the VFD decelerates to reduce the output frequency during the set time. When the frequency decreases to 0Hz, the VFD stops.</p> <p>1: Coast to stop. After the stop command becomes valid, the VFD ceases the output immediately. And the load coasts to stop at the mechanical inertia.</p>	0	○
P01.09	Starting frequency of DC braking while	Starting frequency of DC braking while stop: Start DC braking for stop when running	0.00Hz	○

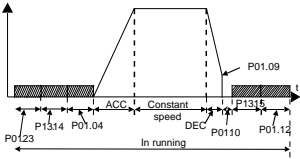
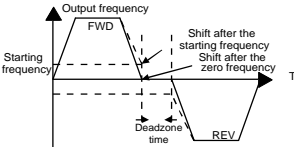
Function code	Name	Description	Default value	Modify
	stop	frequency reaches the starting frequency determined by P01.09.		
P01.10	Wait time before DC braking	Wait time before DC braking: The VFD blocks the output before starting DC braking. After this wait time, the DC braking will be started so as to prevent over-current fault caused by DC braking at high speed.	0.00s	<input type="radio"/>
P01.11	DC braking current at stop	DC braking current at stop: The value of P01.11 is the percentage of rated current of VFD. The bigger the DC braking current is, the greater the braking torque is.	0.0%	<input type="radio"/>
P01.12	DC braking time at stop	DC braking time at stop: It indicates the retention time of DC braking. If the time is 0, the DC braking is invalid, and the VFD will coast to stop.  <p>Setting range of <a href="#">P01.09</a>: 0.00Hz–<a href="#">P00.03</a> (Max. output frequency)            Setting range of <a href="#">P01.10</a>: 0.00–50.00s            Setting range of <a href="#">P01.11</a>: 0.0–100.0% (rated current peak of the VFD)            Setting range of <a href="#">P01.12</a>: 0.00–50.00s</p>	0.00s	<input type="radio"/>
P01.13	FWD/REV running deadzone time	This function code indicates the transition time specified in <a href="#">P01.14</a> during FWD/REV rotation switching.  <p>Setting range: 0.0–3600.0s</p>	0.0s	<input type="radio"/>

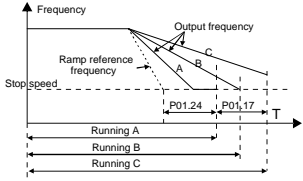
Function code	Name	Description	Default value	Modify
P01.14	FWD/REV running switching mode	This function code indicates the mode of switching between FWD and REV rotations. 0: Switch at zero frequency 1: Switch at the starting frequency 2: Switch after the speed reaches the stop speed with a delay	1	☉
P01.15	Stop speed	0.00–100.00Hz	0.50Hz	☉
P01.16	Stop speed detection mode	0: Detect at the set speed 1: Detect at the feedback speed (valid for vector control only)	1	☉
P01.17	Feedback speed detection time	 <p>When <a href="#">P01.16</a>=1, the actual output frequency of the VFD is less than or equal to <a href="#">P01.15</a> and is detected during the time set by <a href="#">P01.17</a>, the VFD will stop; otherwise, the VFD stops within the time set by <a href="#">P01.24</a>. Setting range: 0.00–100.00s (valid only when <a href="#">P01.16</a>=1)</p>	0.50s	☉
P01.18	Terminal based running command protection at power-on	When the channel of running commands is terminal control, the system will detect the state of the running terminal during powering on. 0: The terminal running command is invalid when powering on. Even the running command is detected to be valid during powering on, the VFD does not run and it keeps the protection state until the running command is canceled and enabled again. 1: The terminal running command is valid when powering on. If the running command is detected to be valid during powering on, the VFD is	0	○

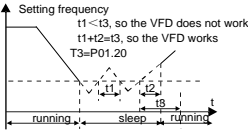
Function code	Name	Description	Default value	Modify
		started automatically after the initialization. <b>Note:</b> Exercise caution before using this function. Otherwise, serious result may follow.		
P01.19	Action performed when the running frequency is lower than the lower frequency limit (valid when the lower frequency limit is greater than 0)	This function code determines the running state of the VFD when the set frequency is lower than the lower-limit one. 0: Run at the lower-limit frequency 1: Stop 2: Sleep The VFD will coast to stop when the set frequency is lower than the lower-limit one. If the set frequency exceeds the lower limit one again and it lasts for the time set by <a href="#">P01.20</a> , the VFD resumes the running state automatically.	0	☉
P01.20	Delay for recovery from hibernation	This function code determines the sleep delay time. When the running frequency of the VFD is lower than the lower limit one, the VFD becomes standby. When the set frequency exceeds the lower limit one again and it lasts for the time set by <a href="#">P01.20</a> , the VFD will run automatically.  Setting range: 0.0–3600.0s (valid when <a href="#">P01.19</a> =2)	0.0s	○
P01.21	Restart after power outage	This function code indicates whether the VFD automatically runs after re-power on. 0: Disable 1: Enable. If the restart condition is met, the VFD will run automatically after waiting the time defined by <a href="#">P01.22</a> .	0	○
P01.22	Wait time for restart after	This function code indicates the wait time before the automatic running of the VFD that is	1.0s	○

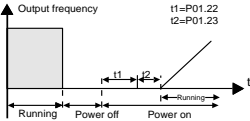
Function code	Name	Description	Default value	Modify
	power outage	re-powered on.  <p>Setting range: 0.0–3600.0s (valid when <a href="#">P01.21</a>=1)</p>		
P01.23	Restart delay	After a VFD running command is given, the VFD is in standby state and restarts with the delay defined by <a href="#">P01.23</a> to implement brake release. Setting range: 0.0–60.0s	0.0s	<input type="radio"/>
P01.24	Stop speed delay	Setting range: 0.0–100.0 s	0.0s	<input type="radio"/>
P01.25	0Hz output	This function code indicates the 0Hz output of the VFD. 0: Output without voltage 1: Output with voltage 2: Output with the DC braking current at stop	0	<input type="radio"/>
<b>P02 Parameters of motor 1</b>				
P02.01	Rated power of AM	0.1–3000.0kW	Parameters of the controlled AM.	Model depended <input type="radio"/>
P02.02	Rated frequency of AM	0.01Hz– <a href="#">P00.03</a>	To ensure the control performance, set <a href="#">P02.01</a> – <a href="#">P02.05</a> correctly according to the information on the nameplate of the AM.	50.00Hz <input type="radio"/>
P02.03	Rated speed of AM	1–36000rpm	Goodrive18 series VFD	Model depended <input type="radio"/>
P02.04	Rated voltage of AM	0–1200V	provides the parameter autotuning function. Whether parameter autotuning can be performed properly depends on the settings of the motor nameplate parameters.	Model depended <input type="radio"/>
P02.05	Rated current of AM	0.8–6000.0A	In addition, you need to configure a motor based on the	Model depended <input type="radio"/>

Function code	Name	Description		Default value	Modify
			standard motor configuration of the VFD. If the power of the motor is greatly different from that of the standard motor configuration, the control performance of the VFD degrades significantly. <b>Note:</b> Resetting the rated power of the motor ( <a href="#">P02.01</a> ) can initialize the parameters of <a href="#">P02.02</a> to <a href="#">P02.10</a> .		
P02.06	Stator resistor of AM	0.001–65.535Ω	After motor parameter autotuning is properly performed, the values of <a href="#">P02.06</a> to <a href="#">P02.10</a> are automatically updated. These parameters are the reference parameters for high-performance vector control, directly affecting the control performance. <b>Note:</b> Do not modify these parameters unless it is necessary.	Model depended	<input type="radio"/>
P02.07	Rotor resistor of AM	0.001–65.535Ω		Model depended	<input type="radio"/>
P02.08	Leakage inductance of AM	0.1–6553.5mH		Model depended	<input type="radio"/>
P02.09	Mutual inductance of AM	0.1–6553.5mH		Model depended	<input type="radio"/>
P02.10	Non-load current of AM	0.1–6553.5A		Model depended	<input type="radio"/>
P02.11	Magnetic saturation coefficient 1 for the iron core of AM	0.0–100.0%		80.0%	<input checked="" type="radio"/>
P02.12	Magnetic saturation coefficient 2 for the iron core of AM	0.0–100.0%		68.0%	<input checked="" type="radio"/>
P02.13	Magnetic	0.0–100.0%		57.0%	<input checked="" type="radio"/>

Function code	Name	Description	Default value	Modify
	saturation coefficient 3 for the iron core of AM			
P02.14	Magnetic saturation coefficient 4 for the iron core of AM	0.0–100.0%	40.0%	☉
P02.26	Motor overload protection selection	0: No protection 1: Common motor (with low speed compensation). Because the heat-releasing effect of the common motors will be weakened, the corresponding electric heat protection will be adjusted properly. The low speed compensation characteristic mentioned here means reducing the threshold of the overload protection of the motor whose running frequency is below 30 Hz. 2: Variable-frequency motor (without low speed compensation). Because the heat-releasing of the specific motors is not impacted by the rotation speed, it is not necessary to adjust the protection value during low-speed running.	2	☉
P02.27	Motor overload protection coefficient	Motor overload multiple $M = I_{out}/(I_n * K)$ $I_n$ is the rated current of the motor, $I_{out}$ is the output current of the VFD and $K$ is the motor protection coefficient. So, a smaller value of $K$ indicates a bigger value of $M$ . When $M=116\%$ , protection is performed after motor overload lasts for 1 hour; when $M=150\%$ , protection is performed after motor overload lasts for 12 minutes; when $M=180\%$ , protection is performed after motor overload lasts for 5 minutes; when $M=200\%$ , protection is performed after motor overload lasts for 60 seconds; and when $M \geq 400\%$ , protection is performed	100.0%	○

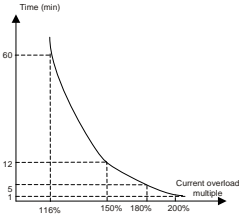

Function code	Name	Description	Default value	Modify
		immediately.  Setting range: 20.0%–120.0%		
<b>P03 Vector control</b>				
P03.00	ASR proportional gain 1	The speed loop dynamic response characteristics of vector control can be adjusted by setting the proportional coefficient and integral time of speed regulator. Increase proportional gain or decrease integral time can accelerate dynamic response of speed loop, however, if the proportional gain is too large or integral time is too small, system oscillation and overshoot may occur; if proportional gain is too small, stable oscillation or speed offset may occur.	20.0	<input type="radio"/>
P03.01	ASR integral time 1		0.200s	<input type="radio"/>
P03.02	Low-point frequency for switching		5.00Hz	<input type="radio"/>
P03.03	ASR proportional gain 2		20.0	<input type="radio"/>
P03.04	ASR integral time 2		0.200s	<input type="radio"/>
P03.05	High-point frequency for switching		10.00Hz	<input type="radio"/>

The parameters [P03.00–P03.05](#) only apply to vector control mode. Below the switching frequency 1 ([P03.02](#)), the speed loop PI parameters are: [P03.00](#) and [P03.01](#). Above the switching frequency 2 ([P03.05](#)), the speed loop PI parameters are: [P03.03](#) and [P03.04](#). PI parameters are gained according to the linear change of two groups of parameters. See the following figure:

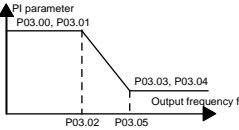
Function code	Name	Description	Default value	Modify
		 <p>PI parameters have a close relationship with the inertia of the system. Adjust PI parameters depending on different loads to meet various demands.</p> <p>Setting range of <a href="#">P03.00</a> and <a href="#">P03.03</a>: 0–200.0            Setting range of <a href="#">P03.01</a> and <a href="#">P03.04</a>: 0.000–10.000s            Setting range of <a href="#">P03.02</a>: 0.00Hz–<a href="#">P03.05</a>            Setting range of <a href="#">P03.05</a>: <a href="#">P03.02</a>–<a href="#">P00.03</a> (Max. output frequency)</p>		
P03.06	ASR output filter	0–8 (corresponding to 0–2 <sup>8</sup> /10ms)	0	<input type="radio"/>
P03.07	Compensation coefficient of vector control electromotion slip	Slip compensation coefficient is used to adjust the slip frequency of the vector control and improve the speed control accuracy of the system. Adjusting the parameter properly can control the speed steady-state error.	100%	<input type="radio"/>
P03.08	Compensation coefficient of vector control brake slip	Setting range: 50%–200%	100%	<input type="radio"/>
P03.09	Current loop percentage coefficient P	<b>Note:</b> The two parameters adjust the PI adjustment parameters of the current loop, affecting the dynamic response speed and control accuracy directly. Generally, you do not need to change the default values.	1000	<input type="radio"/>
P03.10	Current loop integral coefficient I	Applicable to <a href="#">P00.00</a> =0 Setting range: 0–65535	1000	<input type="radio"/>
P03.11	Torque setting method	This function code is used to enable the torque control mode, and set the torque setting means. 0: Torque control is invalid	0	<input type="radio"/>

Function code	Name	Description	Default value	Modify
		1: Keypad ( <a href="#">P03.12</a> ) 2: Reserved 3: Analog AI2 4: Analog AI3 5: Reserved 6: Multi-step speed 7: Modbus communication 8–10: Reserved  Note: Setting mode 2–7, 100% corresponds to 3 times of the motor rated current <b>Note:</b> For setting methods 2–7, 100% corresponds to 3 times the motor rated current.		
P03.12	Torque set through keypad	Setting range: -300.0%–300.0% (of the motor rated current)	50.0%	<input type="radio"/>
P03.13	Torque given filter time	0.000–10.000s	0.100s	<input type="radio"/>
P03.14	Setting source of forward rotation upper-limit frequency in torque control	0: Keypad (P03.16 sets P03.14, P03.17 sets P03.15) 1: Reserved 2: AI2 3: AI3 4: Reserved	0	<input type="radio"/>
P03.15	Setting source of reverse rotation upper-limit frequency in torque control	5: Multi-step speed 6: Modbus communication 7–9: Reserved <b>Note:</b> For setting methods 1–9, 100% corresponds to the maximum frequency	0	<input type="radio"/>
P03.16	Forward rotation upper-limit frequency set through keypad in torque control	The function codes are used to set the frequency upper limits. <a href="#">P03.16</a> sets the value of <a href="#">P03.14</a> ; <a href="#">P03.17</a> sets the value of <a href="#">P03.15</a> .	50.00 Hz	<input type="radio"/>
P03.17	Reverse rotation upper-limit frequency set through keypad	Setting range: 0.00 Hz– <a href="#">P00.03</a> (Max. output frequency)	50.00 Hz	<input type="radio"/>

Function code	Name	Description	Default value	Modify
	in torque control			
P03.18	Setting source of electromotion torque upper limit	The function codes are used to select the sources for setting electromotion and braking torque upper limits. 0: Keypad ( <a href="#">P03.20</a> sets <a href="#">P03.18</a> and <a href="#">P03.21</a> sets <a href="#">P03.19</a> )	0	<input type="radio"/>
P03.19	Setting source of braking torque upper limit	1: Reserved 2: AI2 3: AI3 4: Reserved 5: Modbus communication 6–8: Reserved <b>Note:</b> For setting methods 1–8, 100% corresponds to three times the motor current.	0	<input type="radio"/>
P03.20	Electromotion torque upper limit set through keypad	This function code is used to set the torque limit. Setting range: 0.0–300.0% (of the motor rated current)	180.0%	<input type="radio"/>
P03.21	Braking torque upper limit set through keypad		180.0%	<input type="radio"/>
P03.22	Weakening coefficient in constant power zone	Used when the motor is in weakening control. The function codes <a href="#">P03.22</a> and <a href="#">P03.23</a> are valid at constant power. The motor will enter the weakening state when the motor runs at the rated speed. Change the weakening curve by modifying the weakening control coefficient. The bigger the weakening control coefficient is, the steeper the weak curve is.	0.3	<input type="radio"/>
P03.23	Lowest weakening point in constant power zone		20%	<input type="radio"/>

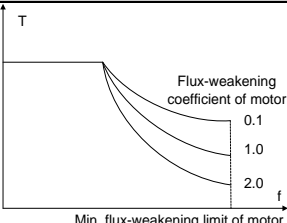
Function code	Name	Description	Default value	Modify
		 <p>Setting range of <a href="#">P03.22</a>: 0.1–2.0 Setting range of <a href="#">P03.23</a>: 10%–100%</p>		
P03.24	Max. voltage limit	<a href="#">P03.24</a> sets the max. output voltage of the VFD, which is dependent on the site situation. Setting range: 0.0–120.0%	100.0%	☉
P03.25	Pre-exciting time	Pre-exciting is performed for the motor when the VFD starts up. A magnetic field is built up inside the motor to improve the torque performance during the starting process. Setting range: 0.000–10.000s	0.300s	○
P03.26	Weakening proportional gain	0 – 8000	1200	○
P03.27	Speed display selection in vector control	0: Display the actual value 1: Display the set value	0	○
P03.28	Static friction compensation coefficient	0.0–100.0%	0.0%	○
P03.29	Dynamical friction compensation coefficient	0.0–100.0%	0.0%	○
<b>P04 SVPWM control</b>				
P04.00	V/F curve setting	This function codes defines the V/F curve of motor 1 to meet the needs of different loads. 0: Straight V/F curve, applying to constant torque	0	☉

Function code	Name	Description	Default value	Modify
		<p>load</p> <p>1: Multi-points V/F curve</p> <p>2: Torque step-down V/F curve (1.3 order)</p> <p>3: Torque step-down V/F curve (1.7 order)</p> <p>4: Torque step-down V/F curve (2.0 order)</p> <p>Curves 2 – 4 apply to the torque loads such as fans and water pumps. You can adjust according to the characteristics of the loads to achieve best performance.</p> <p>5: Customized V/F (V/F separation); in this mode, V can be separated from f and f can be adjusted through the frequency given channel set by <a href="#">P00.06</a> or the voltage given channel set by <a href="#">P04.27</a> to change the characteristics of the curve.</p> <p><b>Note:</b> In the following figure, <math>V_b</math> is the motor rated voltage and <math>f_b</math> is the motor rated frequency.</p>		
P04.01	Torque boost	In order to compensate for low-frequency torque characteristics, you can make some boost compensation to the output voltage. <a href="#">P04.01</a> is relative to the maximum output voltage $V_b$ .	0.0%	<input type="radio"/>
P04.02	Torque boost cut-off	<p><a href="#">P04.02</a> defines the percentage of cut-off frequency of manual torque boost to the rated motor frequency <math>f_b</math>. Torque boost can improve the low-frequency torque characteristics of SVPWM.</p> <p>You should select torque boost based on the load. For example, larger load requires larger torque boost, however, if the torque boost is too large, the motor will run at over-excitation, which will cause increased output current and motor</p>	20.0%	<input type="radio"/>

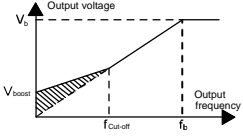
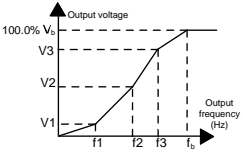
Function code	Name	Description	Default value	Modify
		<p>heat-up, thus decreasing the efficiency. When torque boost is set to 0.0%, the VFD uses automatic torque boost. Torque boost cut-off threshold: Below this frequency threshold, the torque boost is valid, exceeding this threshold will invalidate torque boost.</p>  <p>Setting range of <a href="#">P04.01</a>: 0.0%: (automatic) 0.1%–10.0% Setting range of <a href="#">P04.02</a>: 0.0%–50.0%</p>		
P04.03	V/F frequency point 1	<p>When <a href="#">P04.00</a>=1 (multi-dot V/F curve), you can set the V/F curve through <a href="#">P04.03</a> – <a href="#">P04.08</a>.</p> 	0.00Hz	<input type="radio"/>
P04.04	V/F voltage point 1		0.0%	<input type="radio"/>
P04.05	V/F frequency point 2		0.00Hz	<input type="radio"/>
P04.06	V/F voltage point 2		0.0%	<input type="radio"/>
P04.07	V/F frequency point 3		The V/F curve is generally set according to the load of the motor.	0.00Hz
P04.08	V/F voltage point 3	<p><b>Note:</b> <math>V1 &lt; V2 &lt; V3</math>, <math>f1 &lt; f2 &lt; f3</math>. Too high voltage for low frequency will cause motor overheat or damage and cause VFD overcurrent stall or overcurrent protection.</p> <p>Setting range of <a href="#">P04.03</a>: 0.00Hz–<a href="#">P04.05</a> Setting range of <a href="#">P04.04</a>, <a href="#">P04.06</a>, <a href="#">P04.08</a>: 0.0%–110.0% (of the motor rated voltage) Setting range of <a href="#">P04.05</a>: <a href="#">P04.03</a>–<a href="#">P04.07</a> Setting range of <a href="#">P04.07</a>: <a href="#">P04.05</a>–<a href="#">P02.02</a> (of the motor rated frequency)</p>	0.0%	<input type="radio"/>

Function code	Name	Description	Default value	Modify
P04.09	V/F slip compensation gain	This function code is used to compensate the motor rotation speed change caused by load change during SVPWM control to improve the rigidity of the motor. The rated slip frequency of the motor needs to be calculated. $\Delta f = f_b \cdot n \cdot p / 60$ Of which, $f_b$ is the rated frequency of the motor, its function code is <a href="#">P02.02</a> . $n$ is the rated rotating speed of the motor and its function code is <a href="#">P02.03</a> . $p$ is the pole pair of the motor. 100.0% corresponds to the rated slip frequency $\Delta f$ . Setting range: 0.0–200.0%	100.0%	<input type="radio"/>
P04.10	Low frequency vibration control factor	In the SVPWM control mode, current fluctuation may occur to the motor on some frequency, especially the motor with big power. The motor cannot run stably or overcurrent may occur.	10	<input type="radio"/>
P04.11	High frequency vibration control factor	These phenomena can be canceled by adjusting the parameters.	10	<input type="radio"/>
P04.12	Vibration control threshold	Setting range of <a href="#">P04.10</a> and <a href="#">P04.11</a> : 0–100 Setting range of <a href="#">P04.12</a> : 0.00Hz– <a href="#">P00.03</a> (Max. output frequency)	30.00 Hz	<input type="radio"/>
P04.26	Energy-saving operation selection	0: No operation 1: Automatic energy-saving operation The motor on the light load conditions, automatically adjusts the output voltage to save energy.	0	<input checked="" type="radio"/>
P04.27	Channel of setting voltage	This function code is used to select the output voltage setting channel at V/F curve separation. 0: Keypad. The output voltage is determined by <a href="#">P04.28</a> . 1: Reserved 2: AI2 3: AI3 4: Reserved 5: Multi-step speed 6: PID 7: MODBUS communication	0	<input type="radio"/>

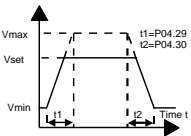
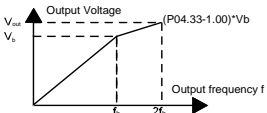

Function code	Name	Description	Default value	Modify
		8 - 10: Reserved <b>Note:</b> For setting methods 1 to 7, 100% corresponds to the rated voltage of the motor.		
P04.28	Voltage set through keypad	This function code is the voltage digital setting when the voltage setting channel is selected as "keypad". Setting range: 0.0%–100.0%	100.0%	○
P04.29	Voltage increasing time	Voltage increasing time is the time when the VFD accelerates from the output minimum voltage to the output maximum voltage.	5.0s	○
P04.30	Voltage decreasing time	Voltage decreasing time is the time when the VFD decelerates from the output maximum voltage to the output minimum voltage. Setting range: 0.0–3600.0s	5.0s	○
P04.31	Max. output voltage	The function codes are used to set the upper and lower limits of output voltage.	100.0%	◎
P04.32	Min. output voltage	 <p>Setting range of <a href="#">P04.31</a>: <a href="#">P04.32</a>–100.0% (of the motor rated voltage) Setting range of <a href="#">P04.32</a>: 0.0%–<a href="#">P04.31</a> (Motor rated voltage)</p>	0.0%	◎
P04.33	Weakening coefficient in constant power zone	This function code is used to adjust the output voltage of the VFD in SVPWM mode during weakening. <b>Note:</b> Invalid in the constant torque mode.  <p>Setting range: 1.00–1.30</p>	1.00	○

**P05 Input terminals**

Function code	Name	Description	Default value	Modify
P05.01	S1 terminal function selection	<b>Note:</b> By default, S1 - S4 are assigned to #1 inverter unit, and S5 - S8 are assigned to #2 inverter unit. If you want to change the configuration, see section 5.2 for details.	1	☉
P05.02	S2 terminal function selection	0: No function 1: Forward rotation operation	4	☉
P05.03	S3 terminal function selection	2: Reverse rotation operation 3: 3-wire control operation 4: Forward jogging	7	☉
P05.04	S4 terminal function selection	5: Reverse jogging 6: Coast to stop 7: Fault reset	0	☉
P05.05	S5 terminal function selection	8: Operation pause 9: External fault input 10: Increasing frequency setting (UP)	0	☉
P05.06	S6 terminal function selection	11: Decreasing frequency setting (DOWN) 12: Cancel the frequency change setting 13: Shift between A setting and B setting	0	☉
P05.07	S7 terminal function selection	14: Shift between combination setting and A setting 15: Shift between combination setting and B setting	0	☉
P05.08	S8 terminal function selection	16: Multi-step speed terminal 1 17: Multi-step speed terminal 2 18: Multi-step speed terminal 3 19: Multi-step speed terminal 4 20: Multi-step speed pause 21: ACC/DEC time selection terminal 1 22: ACC/DEC time selection terminal 2 23: Simple PLC stop reset 24: Simple PLC pause 25: PID control pause 26: Traverse pause (stop at the current frequency) 27: Traverse reset (return to the center frequency) 28: Counter reset	0	☉

Function code	Name	Description	Default value	Modify																				
		29: Torque control prohibition 30: ACC/DEC prohibition 31: Counter trigger 32: Reserved 33: Cancel the frequency change setting temporarily 34: DC brake 35: Reserved 36: Shift the command to the keypad 37: Shift the command to the terminals 38: Shift the command to the communication 39: Pre-magnetized command 40: Clear the power consumption 41: Keep the power consumption 42: Emergency stop 43–60: Reserved 61: PID pole switching 62–63: Reserved When terminals use the ACC/DEC time selection function, it is required to select four groups of ACC/DEC time via state combination of these two terminals. <table border="1" data-bbox="326 856 802 1022"> <thead> <tr> <th>Tml1</th> <th>Tml2</th> <th>ACC/DEC</th> <th>Function code</th> </tr> </thead> <tbody> <tr> <td>OFF</td> <td>OFF</td> <td>ACC/DEC time1</td> <td><a href="#">P00.11/P00.12</a></td> </tr> <tr> <td>ON</td> <td>OFF</td> <td>ACC/DEC time2</td> <td><a href="#">P08.00/P08.01</a></td> </tr> <tr> <td>OFF</td> <td>ON</td> <td>ACC/DEC time3</td> <td><a href="#">P08.02/P08.03</a></td> </tr> <tr> <td>ON</td> <td>ON</td> <td>ACC/DEC time4</td> <td><a href="#">P08.04/P08.05</a></td> </tr> </tbody> </table>	Tml1	Tml2	ACC/DEC	Function code	OFF	OFF	ACC/DEC time1	<a href="#">P00.11/P00.12</a>	ON	OFF	ACC/DEC time2	<a href="#">P08.00/P08.01</a>	OFF	ON	ACC/DEC time3	<a href="#">P08.02/P08.03</a>	ON	ON	ACC/DEC time4	<a href="#">P08.04/P08.05</a>		
Tml1	Tml2	ACC/DEC	Function code																					
OFF	OFF	ACC/DEC time1	<a href="#">P00.11/P00.12</a>																					
ON	OFF	ACC/DEC time2	<a href="#">P08.00/P08.01</a>																					
OFF	ON	ACC/DEC time3	<a href="#">P08.02/P08.03</a>																					
ON	ON	ACC/DEC time4	<a href="#">P08.04/P08.05</a>																					
P05.10	Polarity selection of the input terminals	This function code is used to set the polarity of the input terminals. When the bit is 0, the input terminal is anode. When the bit is 1, the input terminal is cathode. <table border="1" data-bbox="326 1147 802 1281"> <tbody> <tr> <td><b>BIT8</b></td> <td><b>BIT7</b></td> <td><b>BIT6</b></td> <td><b>BIT5</b></td> <td><b>BIT4</b></td> </tr> <tr> <td></td> <td>S8</td> <td>S7</td> <td>S6</td> <td>S5</td> </tr> <tr> <td><b>BIT3</b></td> <td><b>BIT2</b></td> <td><b>BIT1</b></td> <td><b>BIT0</b></td> <td></td> </tr> <tr> <td>S4</td> <td>S3</td> <td>S2</td> <td>S1</td> <td></td> </tr> </tbody> </table> Setting range: 0x000–0x1FF	<b>BIT8</b>	<b>BIT7</b>	<b>BIT6</b>	<b>BIT5</b>	<b>BIT4</b>		S8	S7	S6	S5	<b>BIT3</b>	<b>BIT2</b>	<b>BIT1</b>	<b>BIT0</b>		S4	S3	S2	S1		0x000	○
<b>BIT8</b>	<b>BIT7</b>	<b>BIT6</b>	<b>BIT5</b>	<b>BIT4</b>																				
	S8	S7	S6	S5																				
<b>BIT3</b>	<b>BIT2</b>	<b>BIT1</b>	<b>BIT0</b>																					
S4	S3	S2	S1																					
P05.11	Switch filter time	This function code is used to set the filter time of	0.010s	○																				

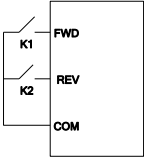
Function code	Name	Description	Default value	Modify															
		sampling of S1–S8. If the interference is strong, increase the parameter to avoid wrong operation. 0.000–1.000s																	
P05.12	Virtual terminal setting	This function code is used to enable virtual terminals in communication mode. 0x000–0x1FF (0: Disable, 1: Enable) BIT0: whether to enable S1 virtual terminal BIT1: whether to enable S2 virtual terminal BIT2: whether to enable S3 virtual terminal BIT3: whether to enable S4 virtual terminal BIT4: whether to enable S5 virtual terminal BIT5: whether to enable S6 virtual terminal BIT6: whether to enable S7 virtual terminal BIT7: whether to enable S8 virtual terminal BIT8: Reserved <b>Note:</b> After a virtual terminal is enabled, the state of the terminal can be changed only in communication mode. The communication address is 0x200A.	0x000	⊙															
P05.13	Terminal control running mode	This function code is used to set the running mode of terminal control. 0: 2-wire control 1, the enabling consistent with the direction. This mode is widely used. The defined FWD/REV terminal command determines the motor rotation direction.  <table border="1" data-bbox="585 987 747 1191"> <thead> <tr> <th>FWD</th> <th>REV</th> <th>Running command</th> </tr> </thead> <tbody> <tr> <td>OFF</td> <td>OFF</td> <td>Stopping</td> </tr> <tr> <td>ON</td> <td>OFF</td> <td>Forward running</td> </tr> <tr> <td>OFF</td> <td>ON</td> <td>Reverse running</td> </tr> <tr> <td>ON</td> <td>ON</td> <td>Hold on</td> </tr> </tbody> </table> 1: 2-wire control 2, separating the enabling from the direction. In this mode, FWD is the enabling terminal. The direction depends on the defined REV state.	FWD	REV	Running command	OFF	OFF	Stopping	ON	OFF	Forward running	OFF	ON	Reverse running	ON	ON	Hold on	0	⊙
FWD	REV	Running command																	
OFF	OFF	Stopping																	
ON	OFF	Forward running																	
OFF	ON	Reverse running																	
ON	ON	Hold on																	

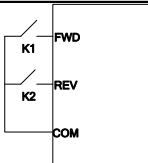
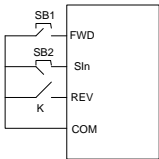
Function code	Name	Description	Default value	Modify																																				
		 <table border="1" data-bbox="582 171 751 381"> <tr> <td><b>FWD</b></td> <td><b>REV</b></td> <td>Running command</td> </tr> <tr> <td><b>OFF</b></td> <td><b>OFF</b></td> <td>Stopping</td> </tr> <tr> <td><b>ON</b></td> <td><b>OFF</b></td> <td>Forward running</td> </tr> <tr> <td><b>OFF</b></td> <td><b>ON</b></td> <td>Stopping</td> </tr> <tr> <td><b>ON</b></td> <td><b>ON</b></td> <td>Reverse running</td> </tr> </table> <p>2: 3-wire control 1. This mode defines Sin as the enabling terminal, and the running command is generated by FWD, the direction is controlled by REV. During running, the Sin terminal should be closed, and terminal FWD generates a rising edge signal, then the VFD starts to run in the direction set by the state of terminal REV; the VFD should be stopped by disconnecting terminal Sin.</p>  <p>The direction control is as follows during operation:</p> <table border="1" data-bbox="329 937 802 1196"> <thead> <tr> <th>Sin</th> <th>REV</th> <th>Previous direction</th> <th>Present direction</th> </tr> </thead> <tbody> <tr> <td rowspan="2">ON</td> <td rowspan="2">OFF→ON</td> <td>Forward</td> <td>Reverse</td> </tr> <tr> <td>Reverse</td> <td>Forward</td> </tr> <tr> <td rowspan="2">ON</td> <td rowspan="2">ON→OFF</td> <td>Reverse</td> <td>Forward</td> </tr> <tr> <td>Forward</td> <td>Reverse</td> </tr> <tr> <td rowspan="2">ON→OFF F</td> <td>ON</td> <td colspan="2" rowspan="2">Decelerate to stop</td> </tr> <tr> <td>OFF</td> </tr> </tbody> </table> <p>Sin: 3-wire control, FWD: Forward running, REV: Reverse running</p> <p>3: 3-wire control 2. This mode defines Sin as the enabling terminal. The running command is</p>	<b>FWD</b>	<b>REV</b>	Running command	<b>OFF</b>	<b>OFF</b>	Stopping	<b>ON</b>	<b>OFF</b>	Forward running	<b>OFF</b>	<b>ON</b>	Stopping	<b>ON</b>	<b>ON</b>	Reverse running	Sin	REV	Previous direction	Present direction	ON	OFF→ON	Forward	Reverse	Reverse	Forward	ON	ON→OFF	Reverse	Forward	Forward	Reverse	ON→OFF F	ON	Decelerate to stop		OFF		
<b>FWD</b>	<b>REV</b>	Running command																																						
<b>OFF</b>	<b>OFF</b>	Stopping																																						
<b>ON</b>	<b>OFF</b>	Forward running																																						
<b>OFF</b>	<b>ON</b>	Stopping																																						
<b>ON</b>	<b>ON</b>	Reverse running																																						
Sin	REV	Previous direction	Present direction																																					
ON	OFF→ON	Forward	Reverse																																					
		Reverse	Forward																																					
ON	ON→OFF	Reverse	Forward																																					
		Forward	Reverse																																					
ON→OFF F	ON	Decelerate to stop																																						
	OFF																																							

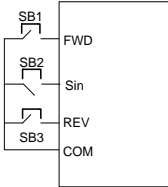
Function code	Name	Description	Default value	Modify																							
		<p>generated by FWD or REV, and they control the running direction. During running, the terminal Sin should be closed, and terminal FWD or REV generates a rising edge signal to control the running and direction of VFD; the VFD should be stopped by disconnecting terminal Sin.</p>  <table border="1" data-bbox="327 605 803 870"> <thead> <tr> <th>SIn</th> <th>FWD</th> <th>REV</th> <th>Running direction</th> </tr> </thead> <tbody> <tr> <td rowspan="2">ON</td> <td>OFF→ON</td> <td>ON</td> <td>Forward</td> </tr> <tr> <td></td> <td>OFF</td> <td>Forward</td> </tr> <tr> <td rowspan="2">ON</td> <td>ON</td> <td rowspan="2">OFF→ON</td> <td>Reverse</td> </tr> <tr> <td>OFF</td> <td>Reverse</td> </tr> <tr> <td rowspan="2">ON→OFF</td> <td>/</td> <td>/</td> <td rowspan="2">Decelerate to stop</td> </tr> <tr> <td>/</td> <td>/</td> </tr> </tbody> </table> <p>SIn: 3-wire control, FWD: Forward running, REV: Reverse running</p> <p><b>Note:</b> In the 2-wire running mode, when the <b>FWD/REV</b> terminal is valid, but the VFD stops because of the stopping command from another source, even when the control terminal <b>FWD/REV</b> keeps valid, the VFD does not run after the stopping command is terminated. Only when <b>FWD/REV</b> is re-triggered, the VFD can start again, for example, the PLC single-cycle stop, fixed-length stop and terminal-controlled valid <b>STOP/RST</b> stop (see <a href="#">P07.04</a>).</p>	SIn	FWD	REV	Running direction	ON	OFF→ON	ON	Forward		OFF	Forward	ON	ON	OFF→ON	Reverse	OFF	Reverse	ON→OFF	/	/	Decelerate to stop	/	/		
SIn	FWD	REV	Running direction																								
ON	OFF→ON	ON	Forward																								
		OFF	Forward																								
ON	ON	OFF→ON	Reverse																								
	OFF		Reverse																								
ON→OFF	/	/	Decelerate to stop																								
	/	/																									
P05.14	S1 terminal switching on delay time	The function codes define the corresponding delay time of electrical level change when the programmable terminals are switched on to	0.000s	○																							

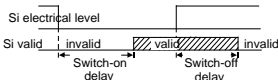
Function code	Name	Description	Default value	Modify
P05.15	S1 terminal switching off delay time	switched off.  Setting range: 0.000–50.000s	0.000s	<input type="radio"/>
P05.16	S2 terminal switching on delay time		0.000s	<input type="radio"/>
P05.17	S2 terminal switching off delay time		0.000s	<input type="radio"/>
P05.18	S3 terminal switching on delay time		0.000s	<input type="radio"/>
P05.19	S3 terminal switching off delay time		0.000s	<input type="radio"/>
P05.20	S4 terminal switching on delay time		0.000s	<input type="radio"/>
P05.21	S4 terminal switching off delay time		0.000s	<input type="radio"/>
P05.22	S5 terminal switching on delay time		0.000s	<input type="radio"/>
P05.23	S5 terminal switching off delay time		0.000s	<input type="radio"/>
P05.24	S6 terminal switching on delay time		0.000s	<input type="radio"/>
P05.25	S6 terminal switching off delay time		0.000s	<input type="radio"/>
P05.26	S7 terminal switching on delay time		0.000s	<input type="radio"/>

Function code	Name	Description	Default value	Modify
P05.27	S7 terminal switching off delay time		0.000s	<input type="radio"/>
P05.28	S8 terminal switching on delay time		0.000s	<input type="radio"/>
P05.29	S8 terminal switching off delay time		0.000s	<input type="radio"/>
P05.37	Lower limit of AI2	<p><b>Note:</b> By default, AI2 is assigned to #1 inverter unit, and AI3 is assigned to #2 inverter unit. If you want to change the configuration, see section 5.2 for details.</p> <p>AI2 is set by the control terminal AI2, AI3 is set by control terminal AI3.</p> <p>The function codes define the relationship between the analog input voltage and its corresponding set value. If the analog input voltage exceeds the set minimum or maximum input value, the VFD uses the minimum or maximum value.</p> <p>When the analog input is the current input, the corresponding voltage of 0–20 mA is 0–10 V. In different cases, the corresponding value of 100.0% is different. See the application for detailed information.</p> <p>Input filter time: This function code is used to adjust the sensitivity of analog input. Increasing the value properly can enhance the anti-interference of analog, but weaken the sensitivity of analog input</p> <p><b>Note:</b> AI2 supports 0–10 V or 0–20 mA input.</p> <p>When AI2 selects 0–20 mA input, the corresponding voltage of 20 mA is 10 V. AI3 supports the input of -10V – +10V.</p> <p>See the following figure.</p>	0.00V	<input type="radio"/>
P05.38	Corresponding setting of the lower limit of AI2		0.0%	<input type="radio"/>
P05.39	Upper limit of AI2		10.00V	<input type="radio"/>
P05.40	Corresponding setting of the upper limit of AI2		100.0%	<input type="radio"/>
P05.41	AI2 input filter time		0.100s	<input type="radio"/>
P05.42	Lower limit of AI3		-10.00V	<input type="radio"/>
P05.43	Corresponding setting of the lower limit of AI3		-100.0%	<input type="radio"/>
P05.44	Middle value of AI3		0.00V	<input type="radio"/>
P05.45	Corresponding setting of middle value of AI3		0.0%	<input type="radio"/>
P05.46	Upper limit of AI3		10.00V	<input type="radio"/>
P05.47	Corresponding setting of the	100.0%	<input type="radio"/>	

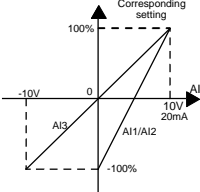

Function code	Name	Description	Default value	Modify
	upper limit of AI3	 <p><a href="#">P05.32</a> setting range: 0.00V–<a href="#">P05.34</a>  <a href="#">P05.33</a>, <a href="#">P05.35</a> setting range: -100.0%–100.0%  <a href="#">P05.34</a> setting range: <a href="#">P05.32</a>–10.00V  <a href="#">P05.36</a> setting range: 0.000s–10.000s  <a href="#">P05.37</a> setting range: 0.00V–<a href="#">P05.39</a>  <a href="#">P05.38</a>, <a href="#">P05.40</a> setting range: -100.0%–100.0%  <a href="#">P05.39</a> setting range: <a href="#">P05.37</a>–10.00V  <a href="#">P05.41</a> setting range: 0.000s–10.000s  <a href="#">P05.42</a> setting range: -10.00V–<a href="#">P05.44</a>  <a href="#">P05.43</a>, <a href="#">P05.45</a>, <a href="#">P05.47</a> setting range: -100.0%–100.0%  <a href="#">P05.44</a> setting range: <a href="#">P05.42</a>–<a href="#">P05.46</a>  <a href="#">P05.46</a> setting range: <a href="#">P05.44</a>–10.00V  <a href="#">P05.48</a> setting range: 0.000s–10.000s</p>	0.100s	○
P05.48	AI3 input filter time			
P05.49	AI2 input signal type	0: Voltage 1: Current	0	◎
<b>P06 Output terminals</b>				
P06.03	RO1 output selection	<b>Note:</b> By default, RO1 is assigned to #1 inverter unit, and RO2 is assigned to #2 inverter unit. If you want to change the configuration, see section 5.2 for details. 0: Invalid 1: Running 2: Forward rotation 3: Reverse rotation 4: Jogging 5: VFD fault 6: Frequency level test FDT1	1	○
P06.04	RO2 output selection		5	○

Function code	Name	Description	Default value	Modify								
		7: Frequency level test FDT2 8: Frequency arrival 9: Zero speed running 10: Upper limit frequency arrival 11: Lower limit frequency arrival 12: Ready for operation 13: Pre-magnetizing 14: Overload pre-alarm 15: Underload pre-alarm 16: Completion of simple PLC stage 17: Completion of simple PLC cycle 18: Set counting value arrival 19: Designated counting value arrival 20: External fault valid 21: Reserved 22: Running time arrival 23: Modbus communication virtual terminal output 24–25: Reserved 26: Establishment of DC bus voltage 27–30: Reserved										
P06.05	Polarity selection of output terminals	This function code is used to set the pole of the output terminal. When the current bit is set to 0, the input terminal is positive. When the current bit is set to 1, the input terminal is negative. <table border="1" data-bbox="326 1030 803 1097"> <tr> <td>BIT3</td> <td>BIT2</td> <td>BIT1</td> <td>BIT0</td> </tr> <tr> <td>Reserved</td> <td>Reserved</td> <td>RO2</td> <td>RO1</td> </tr> </table> Setting range: 0–F	BIT3	BIT2	BIT1	BIT0	Reserved	Reserved	RO2	RO1	0	○
BIT3	BIT2	BIT1	BIT0									
Reserved	Reserved	RO2	RO1									
P06.10	RO1 switching on delay time	The function codes define the corresponding delay time of the electrical level change when the programmable terminals are switched on and off.	0.000s	○								
P06.11	RO1 switching off delay time		0.000s	○								
P06.12	RO2 switching on delay time		0.000s	○								

Function code	Name	Description	Default value	Modify
P06.13	RO2 switching off delay time	<p>Setting range: 0.000–50.000s</p>	0.000s	<input type="radio"/>
P06.14	AO1 output selection	<p><b>Note:</b> By default, AO1 is assigned to #1 inverter unit, and AO2 is assigned to #2 inverter unit. If you want to change the configuration, see section 5.2 for details.</p> <p>0: Running frequency 1: Set frequency 2: Ramp reference frequency 3: Running rotation speed 4: Output current (relative to twice the rated current of the VFD) 5: Output current (relative to twice the rated current of the motor) 6: Output voltage 7: Output power 8: Set torque value</p>	0	<input type="radio"/>
P06.15	AO2 output selection	<p>9: Output torque 10: Reserved 11: AI2 input 12: AI3 input 13: Reserved 14: Value 1 set through MODBUS communication 15: Value 2 set through MODBUS communication 16–21: Reserved 22: Torque current (relative to 3 times the rated current of the motor) 23: Ramp reference frequency (with sign) 24: Invalid 25–30: Reserved</p>	0	<input type="radio"/>
P06.17	AO1 output lower limit	The function codes define the relationship between the output value and analog output.	0.0%	<input type="radio"/>

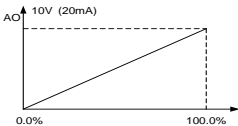
Function code	Name	Description	Default value	Modify
P06.18	AO1 output corresponding to lower limit	When the output value exceeds the range of set maximum or minimum output, it will count according to the low-limit or upper-limit output.	0.00V	<input type="radio"/>
P06.19	AO1 output upper limit	When the analog output is current output, 1mA equals 0.5V.	100.0%	<input type="radio"/>
P06.20	AO1 output corresponding to upper limit	In different cases, the corresponding analog output of 100% of the output value is different. Refer to each application for detailed information.	10.00V	<input type="radio"/>
P06.21	AO1 output filter time		0.000s	<input type="radio"/>
P06.22	AO2 output lower limit		0.0%	<input type="radio"/>
P06.23	AO2 output corresponding to lower limit		0.00V	<input type="radio"/>
P06.24	AO2 output upper limit		100.0%	<input type="radio"/>
P06.25	AO2 output corresponding to upper limit		10.00V	<input type="radio"/>
P06.26	AO2 output filter time		0.000s	<input type="radio"/>
 <p><a href="#">P06.17</a> setting range: -100.0%–<a href="#">P06.19</a>  <a href="#">P06.18</a> setting range: 0.00V–10.00V  <a href="#">P06.19</a> setting range: <a href="#">P06.17</a>–100.0%  <a href="#">P06.20</a> setting range: 0.00V–10.00V  <a href="#">P06.21</a> setting range: 0.000s–10.000s  <a href="#">P06.22</a> setting range: -100.0%–<a href="#">P06.24</a>  <a href="#">P06.23</a> setting range: 0.00V–10.00V  <a href="#">P06.24</a> setting range: <a href="#">P06.22</a>–100.0%  <a href="#">P06.25</a> setting range: 0.00V–10.00V  <a href="#">P06.26</a> setting range: 0.000s–10.000s</p>				
<b>P07 Human-machine interface</b>				
P07.00	User password	0–65535 When you set <a href="#">P07.00</a> set to a non-zero value, the password protection mechanism is enabled immediately. 00000: This setting clear the set user password and disables password protection. When you set <a href="#">P07.00</a> to a non-zero value, the value is the user password. After you exit the function code editing interface, the password protection function is enabled within 1 minute. If password protection is enabled, "0.0.0.0.0" is	0	<input type="radio"/>

Function code	Name	Description	Default value	Modify
		<p>displayed when you press the <b>PRG/ESC</b> key again to enter the function code editing interface. You need to enter the correct user password to enter the interface.</p> <p><b>Note:</b> Exercise caution before restoring the function code to the default value, which will clear the user password.</p>		
P07.01	Parameter copying	<p>0: No operation            1: Upload local function parameters to the keypad            2: Download keypad function parameters to a local address (including motor parameters)            3: Download keypad function parameters to a local address (excluding the motor parameters of P02 and P12)            4: Download keypad function parameters to a local address (only including the motor parameters of P02 and P12)</p> <p><b>Note:</b> After any of operation options 1–4 is performed, the parameter is restored to 0, and the upload and download functions are not applicable to P29. This function is only applicable to the external keypad with parameter copying.</p>	0	⊙
P07.02	Key function selection	<p>0x00–0x27</p> <p>Ones: <b>QUICK/JOG</b> key function</p> <p>0: None            1: Jogging            2: Shifting-key switchover display status            3: Switchover between FWD/REV rotations            4: Clear <b>UP/DOWN</b> setting            5: Coast to stop            6: Switch running-command giving modes in sequence            7: Quick commission mode (based on non factory parameters)</p> <p>Tens:            0: Not lock keys</p>	0x01	⊙

Function code	Name	Description	Default value	Modify
		1: Lock all keys 2: Lock only <b>PRG/ESC</b>		
P07.03	Running command channel switchover sequence of <b>QUICK/JOG</b>	When <b>P07.02</b> =6, set the switchover sequence of running command channels. 0: Keypad control→Terminals control→Communication control 1: Keypad control↔Terminal control 2: Keypad control↔Communication control 3: Terminal control↔Communication control	0	○
P07.04	Stop function selection of <b>STOP/RST</b>	This function code is used to select the stop function validity of <b>STOP/RST</b> . For fault reset, <b>STOP/RST</b> is valid at any state. 0: Valid only for keypad control 1: Valid both for keypad and terminal control 2: Valid both for keypad and communication control 3: Valid for all control modes	0	○
P07.05	Displayed parameter selection 1 in running state	0x0000–0xFFFF BIT0: running frequency (Hz on) BIT1: set frequency (Hz blinking) BIT2: bus voltage (Hz on) BIT3: output voltage (V on) BIT4: output current (A on) BIT5: running rotation speed (rpm on) BIT6: output power (% on) BIT7: output torque (% on) BIT8: PID reference value (% blinking) BIT9: PID feedback value (% on) BIT10: input terminal state BIT11: output terminal state BIT12: torque setting (% on) BIT13: pulse counting value BIT14: reserved BIT15: PLC and the current step of multi-step speed	0x03FF	○
P07.06	Displayed parameter	0x0000–0xFFFF BIT0: AI1 value (V on)	0x0000	

Function code	Name	Description	Default value	Modify
	selection 2 in running state	BIT1: AI2 value (V on) BIT2: AI3 value (V on) BIT3: reserved BIT4: motor overload percentage (% on) BIT5: the VFD overload percentage (% on) BIT6: ramp frequency given value (Hz on) BIT7: linear speed BIT8: AC inlet current (A on) BIT9–15: reserved		
P07.07	Displayed parameter selection in stopped state	0x0000–0xFFFF BIT0: set frequency (Hz on, frequency blinking slowly) BIT1: bus voltage (V on) BIT2: input terminal state BIT3: output terminal state BIT4: PID reference value (% blinking) BIT5: PID feedback value (% blinking) BIT6: torque reference (% blinking) BIT7: reserved BIT8: analog AI2 value (V on) BIT9: analog AI3 value (V on) BIT10: reserved BIT11: PLC and the current step of multi-step speed BIT12: pulse counting value BIT13–BIT15: reserved	0x00FF	○
P07.08	Frequency display coefficient	0.01–10.00 Displayed frequency = Running frequency * <a href="#">P07.08</a>	1.00	○
P07.09	Speed display coefficient	0.1–999.9% Mechanical rotation speed = 120 * Displayed running frequency * <a href="#">P07.09</a> /Motor pole pairs	100.0%	○
P07.10	Linear speed display coefficient	0.1–999.9% Linear speed = Mechanical rotation speed * <a href="#">P07.10</a>	1.0%	○
P07.11	Rectifier bridge module	-20.0–120.0°C		●

Function code	Name	Description	Default value	Modify
	temperature			
P07.12	Inverter module temperature	-20.0–120.0°C		●
P07.13	Software version	1.00–655.35		●
P07.14	Local accumulative running time	0–65535h		●
P07.15	VFD power consumption MSB	Used to display VFD power consumption. VFD power consumption = <a href="#">P07.15</a> *1000 + <a href="#">P07.16</a> <a href="#">P07.15</a> setting range: 0–65535kWh (*1000) <a href="#">P07.16</a> setting range: 0.0–999.9kWh		●
P07.16	VFD power consumption LSB			●
P07.17	Reserved	Reserved		●
P07.18	VFD rated power	0.4–3000.0kW		●
P07.19	VFD rated voltage	50–1200V		●
P07.20	VFD rated current	0.1–6000.0A		●
P07.21	Factory bar code 1	0x0000–0xFFFF		●
P07.22	Factory bar code 2	0x0000–0xFFFF		●
P07.23	Factory bar code 3	0x0000–0xFFFF		●
P07.24	Factory bar code 4	0x0000–0xFFFF		●
P07.25	Factory bar code 5	0x0000–0xFFFF		●
P07.26	Factory bar code 6	0x0000–0xFFFF		●
P07.27	Type of present fault	0: No fault 1: Reserved		●
P07.28	Type of last fault	2: Reserved		●



Function code	Name	Description	Default value	Modify
P07.29	Type of 2nd-last fault	3: Reserved 4: Overcurrent during ACC (P-OC1)		●
P07.30	Type of 3rd-last fault	5: Overcurrent during DEC (P-OC2) 6: Overcurrent during constant speed running (P-OC3)		●
P07.31	Type of 4th-last fault	7: Overvoltage during ACC (P-OV1) 8: Overvoltage during DEC (P-OV2) 9: Overvoltage during constant speed running (P-OV3)		●
P07.32	Type of 5th-last fault	10: Bus undervoltage (P-UV) 11: Motor overload (P-OL1) 12: VFD overload (P-OL2) 13: Input side phase loss (P-SPI) 14: Output side phase loss (P-SPO) 15: Reserved 16: Inverter module overheat (P-OH2) 17: External fault (P-EF) 18: RS485 communication fault (P-CE) 19: Current detection fault (P-ItE) 20: Motor autotuning fault (P-tE) 21: EEPROM error (P-EEP) 22: PID feedback disconnection fault (PPIDE) 23: Reserved 24: Running time reached (P-END) 25: Electronic overload (P-OL3) 26: Panel communication fault (P-PCE) 27: Parameter upload fault (P-UPE) 28: Parameter download fault (P-DNE) 29 - 31: Reserved 32: To-ground short circuit fault 1(PETH1) 33: To-ground short circuit fault 2(PETH2) 34: Speed deviation fault (P-dEu) 35: Reserved 36: Underload fault (P-LL) 37: Reserved 38: LIN communication fault (LinCE)		●
P07.33	Running frequency at present fault		0.00Hz	●

Function code	Name	Description	Default value	Modify
P07.34	Ramp reference frequency at present fault		0.00Hz	●
P07.35	Output voltage at present fault		0V	●
P07.36	Output current at present fault		0.0A	●
P07.37	Bus voltage at present fault		0.0V	●
P07.38	Max. temperature at present fault		0.0°C	●
P07.39	Input terminal status at present fault		0	●
P07.40	Output terminal status at present fault		0	●
P07.41	Running frequency at last fault		0.00Hz	●
P07.42	Ramp reference frequency at last fault		0.00Hz	●
P07.43	Output voltage at last fault		0V	●
P07.44	Output current at last fault		0.0A	●
P07.45	Bus voltage at last fault		0.0V	●
P07.46	Max. temperature at last fault		0.0°C	●
P07.47	Input terminal status at last fault		0	●
P07.48	Output terminal status at last fault		0	●
P07.49	Running frequency at 2nd-last fault		0.00Hz	●
P07.50	Ramp reference frequency at 2nd-last fault		0.00Hz	●
P07.51	Output voltage at 2nd-last fault		0V	●
P07.52	Output current at 2nd-last fault		0.0A	●
P07.53	Bus voltage at 2nd-last fault		0.0V	●
P07.54	Max. temperature at 2nd-last fault		0.0°C	●
P07.55	Input terminal status at 2nd-last fault		0	●
P07.56	Output terminal status at 2nd-last fault		0	●
<b>P08 Enhanced functions</b>				
P08.00	ACC time 2	For details, see <a href="#">P00.11</a> and <a href="#">P00.12</a> . Goodrive18 series VFD defines four groups of acceleration/deceleration time, which can be selected by multifunction digital input terminals (P05 group). The acceleration/deceleration time of the VFD is the first group by default. Setting range: 0.0–3600.0s	Model depended	○
P08.01	DEC time 2		Model depended	○
P08.02	ACC time 3		Model depended	○
P08.03	DEC time 3		Model depended	○
P08.04	ACC time 4		Model depended	○
P08.05	DEC time 4		Model depended	○

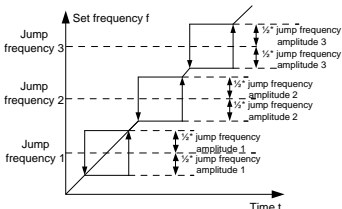
Function code	Name	Description	Default value	Modify
P08.06	Running frequency of jogging	This function code is used to define the reference frequency during jogging. Setting range: 0.00Hz– <a href="#">P00.03</a> (Max. output frequency)	5.00Hz	<input type="radio"/>
P08.07	ACC time of jogging	The jogging ACC time means the time needed if the VFD runs from 0 Hz to the max. output frequency ( <a href="#">P00.03</a> ).	Model depended	<input type="radio"/>
P08.08	DEC time of jogging	The jogging DEC time means the time needed if the VFD goes from the max. output frequency ( <a href="#">P00.03</a> ) to 0 Hz. Setting range: 0.0–3600.0s	Model depended	<input type="radio"/>
P08.09	Jump frequency 1	When the set frequency is within the range of jump frequency, the VFD will run at the boundary of jump frequency. The VFD can avoid mechanical resonance point by setting the jump frequency, and three jump frequency points can be set. If the jump frequency points are set to 0, this function is invalid.	0.00Hz	<input type="radio"/>
P08.10	Jump frequency amplitude 1		0.00Hz	<input type="radio"/>
P08.11	Jump frequency 2		0.00Hz	<input type="radio"/>
P08.12	Jump frequency amplitude 2		0.00Hz	<input type="radio"/>
P08.13	Jump frequency 3		0.00Hz	<input type="radio"/>
P08.14	Jump frequency amplitude 3	 <p>Setting range: 0.00Hz–<a href="#">P00.03</a> (Max. output frequency)</p>	0.00Hz	<input type="radio"/>
P08.15	Amplitude of wobbling frequency	The function codes apply to the industries where traverse and convolution are required such as textile and chemical fiber. The traverse function means that the output frequency of the VFD is fluctuated with the set frequency as its center. The route of the running	0.0%	<input type="radio"/>
P08.16	Amplitude of sudden jump frequency		0.0%	<input type="radio"/>
P08.17	Rise time of		5.0s	<input type="radio"/>

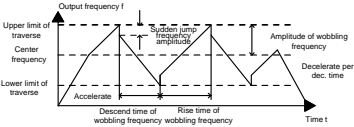
Function code	Name	Description	Default value	Modify
	wobbling frequency	frequency is illustrated as follows, of which the traverse range is set by <a href="#">P08.15</a> . When <a href="#">P08.15</a> is set to 0, traverse does not function.		
P08.18	Descend time of wobbling frequency	 <p>Amplitude of wobbling frequency: The running at wobbling frequency is limited by frequency upper and lower limits.</p> <p>Wobbling amplitude relative to the center frequency: Amplitude of wobbling (AW) = Center frequency × Amplitude of wobbling frequency <a href="#">P08.15</a>.</p> <p>Sudden jump frequency = AW × Amplitude of sudden jump frequency <a href="#">P08.16</a>. During running at the wobbling frequency, the sudden jump frequency is relative to the AW.</p> <p>Rise time of wobbling frequency: The time from the lowest point to the highest one.</p> <p>Descend time of wobbling frequency: The time from the highest point to the lowest one.</p> <p><a href="#">P08.15</a> setting range: 0.0–100.0% (of the set frequency)</p> <p><a href="#">P08.16</a> setting range: 0.0–50.0% (of the amplitude of the wobbling frequency)</p> <p><a href="#">P08.17</a>, <a href="#">P08.18</a> setting range: 0.1–3600.0s</p>	5.0s	<input type="radio"/>
P08.19	Decimal places of linear speed and frequency	<p>Ones: Decimal places in linear speed display</p> <p>0: None</p> <p>1: One</p> <p>2: Two</p> <p>3: Three</p> <p>Tens: Decimal places in frequency display</p> <p>0: Two</p>	0x00	<input type="radio"/>

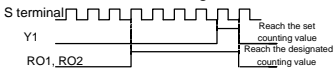
Function code	Name	Description	Default value	Modify
		1: One		
P08.20	Analog calibration function selection	0: Invalid 1: Valid	1	☉
P08.21	DEC time of emergency stop	0.0–6553.5s 0.0 indicates coast to stop.	0.0s	○
P08.25	Set counting value	The counter works by the input pulse signals of the HDI terminals.	0	○
P08.26	Designated counting value	<p>When the counter achieves a fixed number, the multifunction output terminals will output the signal of "Designated counting number arrival" and the counter go on working; when the counter achieves a set number, the multifunction output terminals will output the signal of "Set counting number arrival", the counter will clear all numbers and stop to recount before the next pulse.</p> <p>The designated counting value <a href="#">P08.26</a> should be no more than the set counting value <a href="#">P08.25</a>.</p>  <p><a href="#">P08.25</a> setting range: <a href="#">P08.26</a>–65535 <a href="#">P08.26</a> setting range: 0–<a href="#">P08.25</a></p>	0	○
P08.27	Set running time	This function code indicates the preset running time of the VFD. When the accumulative running time achieves the set time, the multifunction digital output terminals will output the signal of "running time arrival". Setting range: 0–65535min	0m	○
P08.28	Automatic fault reset times	Automatic fault reset times: When the VFD selects automatic fault reset, it is used to set the times of automatic reset.	0	○
P08.29	Automatic fault reset interval	If the number of continuous reset times exceeds the value, the VFD will report a fault and stop. Automatic fault reset interval: Time from when a	1.0s	○

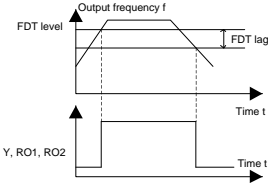
Function code	Name	Description	Default value	Modify
		fault occurred to the time when automatic fault reset action. <a href="#">P08.28</a> setting range: 0–10 <a href="#">P08.29</a> setting range: 0.1–3600.0s		
P08.30	Frequency decreasing ratio in drop control	The output frequency of the VFD changes as the load changes. It is mainly used to balance the power when several motors drive one load. Setting range: -50.00Hz–50.00Hz	0.00Hz	<input type="radio"/>
P08.32	FDT1 electrical level detection value	When the output frequency exceeds the corresponding frequency of FDT electrical level, the multifunction digital output terminal continuously outputs the signal of "Frequency level detection FDT". The signal is invalid only when the output frequency decreases to a value lower than the frequency corresponding to (FDT electrical level—FDT lagging detection value).	50.00Hz	<input type="radio"/>
P08.33	FDT1 lagging detection value		5.0%	<input type="radio"/>
P08.34	FDT2 electrical level detection value		50.00Hz	<input type="radio"/>
P08.35	FDT2 lagging detection value	 <p><a href="#">P08.32</a> setting range: 0.00Hz–<a href="#">P00.03</a> (Max. output frequency) <a href="#">P08.33</a>, <a href="#">P08.35</a> setting range: 0.0–100.0% <a href="#">P08.34</a> setting range: 0.00Hz–<a href="#">P00.03</a> (Max. output frequency)</p>	5.0%	<input type="radio"/>
P08.36	Frequency arrival detection amplitude value	When the output frequency is within the detection range, the multifunction digital output terminal will output the signal of "Frequency arrival".	0.00Hz	<input type="radio"/>

Function code	Name	Description	Default value	Modify
		<p>Setting range: 0.00Hz–<a href="#">P00.03</a> (Max. output frequency)</p>		
P08.39	Running mode of cooling fan	0: Common running mode 1: The fan keeps running after power on	0	<input type="radio"/>
P08.40	PWM selection	0x000–0x0021 Ones: PWM mode 0: 3PH modulation and 2PH modulation 1: 3PH modulation Tens: PWM low-speed carrier frequency limit 0: Limit low-speed carrier frequency to 1K or 2K 1: Limit low-speed carrier frequency to 4K 2: No limit on low-speed carrier frequency	0x01	<input checked="" type="radio"/>
P08.41	Overmodulation selection	Ones: 0: Overmodulation is invalid 1: Overmodulation is valid Tens 0: Mild overmodulation 1: Deepened overmodulation	0x01	<input checked="" type="radio"/>
P08.42	Keypad digit control setting	0x0000–0x1223 LED ones: frequency enabling selection 0: Both $\wedge/\vee$ key adjustment and analog potentiometer adjustment are valid 1: Only $\wedge/\vee$ key adjustment is valid 2: Only analog potentiometer adjustment is valid 3: Neither $\wedge/\vee$ key adjustment nor digital potentiometer adjustment is valid	0x0000	<input type="radio"/>

Function code	Name	Description	Default value	Modify
		<p>LED tens: frequency control selection</p> <p>0: Only valid when <a href="#">P00.06</a>=0 or <a href="#">P00.07</a>=0</p> <p>1: Valid for all frequency setting manners</p> <p>2: Invalid for multi-step speed when multi-step speed has the priority</p> <p>LED hundreds: action selection during stop</p> <p>0: Setting is valid</p> <p>1: Valid during running, cleared after stop</p> <p>2: Valid during running, cleared after receiving the stop command</p> <p>LED thousands: integral function of <math>\wedge/\vee</math> keys and analog potentiometer</p> <p>0: The integral function is valid</p> <p>1: The integral function is invalid</p>		
P08.44	UP/DOWN terminal control setting	<p>0x000–0x221</p> <p>LED ones: terminal setting selection</p> <p>0: <b>UP/DOWN</b> terminal setting is valid</p> <p>1: <b>UP/DOWN</b> terminal setting is invalid</p> <p>LED tens: frequency control selection</p> <p>0: Valid only when <a href="#">P00.06</a>=0 or <a href="#">P00.07</a>=0</p> <p>1: Valid for all frequency setting means</p> <p>2: Invalid for multi-step speed when multi-step speed has the priority</p> <p>LED hundreds: action selection when stop</p> <p>0: Setting is valid</p> <p>1: Valid during running, cleared after stop</p> <p>2: Valid during running, cleared after receiving the stop command</p>	0x000	<input type="radio"/>
P08.45	UP terminal frequency increment integral rate	0.01–50.00s	0.50s	<input type="radio"/>
P08.46	DOWN terminal frequency decrement integral rate	0.01–50.00 s	0.50s	<input type="radio"/>



Function code	Name	Description	Default value	Modify
P08.47	Action selection at power outage during frequency setting	0x000–0x111 LED ones: Action selection at power outage during frequency adjusting through digitals. 0: Save the setting at power outage 1: Clear the setting at power outage LED tens: Action selection at power outage during frequency adjusting through Modbus communication 0: Save the setting at power outage 1: Clear the setting at power outage LED hundreds: Action selection at power outage during frequency adjusting through other communication 0: Save the setting at power outage 1: Clear the setting at power outage	0x000	<input type="radio"/>
P08.48	MSB of initial power consumption	The function codes are used to set the initial value of the power consumption. Initial power consumption = (P08.48*1000 +	0	<input type="radio"/>
P08.49	LSB of initial power consumption	P08.49)kWh P08.48 setting range: 0–59999 P08.49 setting range: 0.0–999.9	0.0	<input type="radio"/>
P08.50	Magnetic flux braking coefficient	This function code is used to enable magnetic flux. 0: Invalid 100–150: A greater coefficient indicates greater braking strength. The VFD can slow down the motor by increasing the magnetic flux. The energy generated by the motor during braking can be transformed into heat energy by increasing the magnetic flux. The VFD monitors the state of the motor continuously even during the magnetic flux period. So the magnetic flux can be used in the motor stop, as well as to change the rotation speed of the motor. The other advantages include:	0	<input type="radio"/>

Function code	Name	Description	Default value	Modify
		Brake immediately after the stop command. It does not need to wait until the magnetic flux weakens. The cooling is better. The current of the stator other than the rotor increases during magnetic flux braking, while the cooling of the stator is more effective than the rotor.		
P08.51	Current regulation coefficient on input side	This function code is used to adjust the current display value on the AC input side. Setting range: 0.00–1.00	0.56	<input type="radio"/>
<b>P09 PID control</b>				
P09.00	PID reference source	When the frequency command selection ( <a href="#">P00.06</a> , <a href="#">P00.07</a> ) is 7 or the voltage setting channel selection ( <a href="#">P04.27</a> ) is 6, the VFD is process PID controlled. This function code determines the target given channel during the PID process. 0: Keypad ( <a href="#">P09.01</a> ) 1: Reserved 2: AI2 3: AI3 4: Reserved 5: Multi-step speed 6: MODBUS communication 7 - 9: Reserved The set target of process PID is a relative value, for which 100% equals 100% of the feedback signal of the controlled system. The system always calculates a related value (0–100.0%). <b>Note:</b> Multi-step speed setting can be realized by setting P10.	0	<input type="radio"/>
P09.01	PID reference preset through keypad	This function code is mandatory when <a href="#">P09.00</a> =0. The base value of this function code is the feedback of the system. Setting range: -100.0%–100.0%	0.0%	<input type="radio"/>

Function code	Name	Description	Default value	Modify
P09.02	PID feedback source	This function code is used to select PID feedback channel. 0: Reserved 1: AI2 2: AI3 3: Reserved 4: MODBUS communication 5: MAX(AI2,AI3) 6 - 7: Reserved <b>Note:</b> The reference channel and feedback channel cannot be duplicate. Otherwise, effective PID control cannot be achieved.	0	<input type="radio"/>
P09.03	PID output characteristics selection	0: PID output is positive. When the feedback signal is greater than the PID reference value, the output frequency of the VFD will decrease to balance the PID. Example: PID control on strain during unwinding. 1: PID output is negative. When the feedback signal is greater than the PID reference value, the output frequency of the VFD will increase to balance the PID. Example: PID control on strain during unwinding.	0	<input type="radio"/>
P09.04	High frequency proportional gain (Kp)	The function is applied to the proportional gain P of PID input. P determines the strength of the whole PID adjuster. The parameter of 100 means that when the offset of PID feedback and given value is 100%, the adjusting range of PID adjuster is the max. frequency (ignoring integral function and differential function). Setting range: 0.00–100.00	1.00	<input type="radio"/>
P09.05	High frequency integral time (Ti)	This function code determines the speed of PID adjuster to carry out integral adjustment on the deviation of PID feedback and reference. When the deviation of PID feedback and reference is 100%, the integral adjuster works continuously after the time (ignoring the	0.10s	<input type="radio"/>

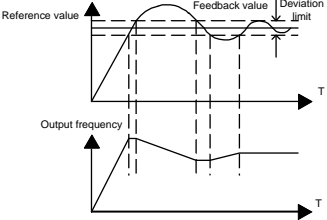
Function code	Name	Description	Default value	Modify
		proportional effect and differential effect) to achieve the max. frequency (P00.03) or the max. voltage (P04.31). Shorter the integral time, stronger is the adjustment. Setting range: 0.00–10.00s		
P09.06	High frequency differential time (Td)	This function code determines the strength of the change ratio when PID adjustor carries out integral adjustment on the deviation of PID feedback and reference. If the PID feedback changes 100% during the time, the adjustment of integral adjustor (ignoring the proportional effect and differential effect) is the max. frequency (P00.03) or the max. voltage (P04.31). Longer integral time indicates stronger adjusting. Setting range: 0.00–10.00s	0.00s	<input type="radio"/>
P09.07	Sampling cycle (T)	This function code means the sampling cycle of the feedback. The modulator calculates in each sampling cycle. A longer sampling cycle indicates slower response. Setting range: 0.001–10.000s	0.100s	<input type="radio"/>
P09.08	PID control deviation limit	The output of the PID system is relative to the maximum deviation of the closed loop reference. As shown in the following diagram, PID adjustor stops during the deviation limit. 	0.0%	<input type="radio"/>

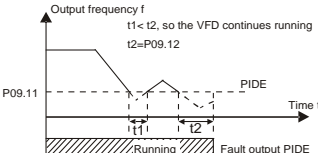
Function code	Name	Description	Default value	Modify
		Setting range: 0.0–100.0%		
P09.09	Upper limit of PID output	The function codes are used to set the upper and lower limits of PID adjustor output.	100.0%	<input type="radio"/>
P09.10	Lower limit of PID output	100.0 % corresponds to max. frequency (P00.03) or the max. voltage of (P04.31). P09.09 setting range: P09.10–100.0% P09.10 setting range: -100.0%–P09.09	0.0%	<input type="radio"/>
P09.11	Feedback disconnection detection value	When the detection value is smaller than or equal to the feedback disconnection detection value, and the lasting time exceeds the set value in P09.12, the VFD will report "PID feedback disconnection fault" and the keypad will display PIDE.	0.0%	<input type="radio"/>
P09.12	Feedback disconnection detection time	 <p>P09.11 setting range: 0.0–100.0% P09.12 setting range: 0.0–3600.0s</p>	1.0s	<input type="radio"/>
P09.13	PID adjustment selection	0x0000–0x1111 LED ones: 0: Keep on integral adjustment when the frequency achieves the upper/lower limit 1: Stop integral adjustment when the frequency reaches the upper/lower limit LED tens: 0: Same as the main reference direction 1: Opposite to the main reference direction LED hundreds: 0: Limit according to the max. frequency 1: Limit according to A frequency LED thousands: 0: A+B frequency, buffering acceleration/deceleration of main reference	0x0001	<input type="radio"/>

Function code	Name	Description	Default value	Modify
		source A frequency is invalid 1: A+B frequency, buffering acceleration/deceleration of main reference source A frequency is valid and the acceleration/deceleration is determined by <a href="#">P08.04</a>		
P09.14	Reserved	0.00–100.00	1.00	○
P09.15	PID command ACC/DEC time	0.0–1000.0s	0.0s	○
P09.16	PID output filter time	0.000–10.000s	0.000s	○
P09.17	Low frequency proportional gain (Kp)	0.00–100.00	1.00	○
P09.18	Low frequency integral time (Ti)	0.00–10.00s	0.10s	○
P09.19	Low frequency differential time (Td)	0.00–10.00s	0.00s	○
P09.20	Low point frequency of PID parameter switching	0.00Hz– <a href="#">P09.21</a> When the ramp frequency is no greater than <a href="#">P09.20</a> , current PID parameters are <a href="#">P09.17</a> – <a href="#">P09.19</a> . When the ramp frequency is no less than <a href="#">P09.21</a> , current PID parameters are <a href="#">P09.04</a> – <a href="#">P09.06</a> . The medium frequency range is the linear interpolation values between the two PID parameter groups.	5.00Hz	○
P09.21	High point frequency of PID parameter switching	<a href="#">P09.20</a> – <a href="#">P00.03</a>	10.00Hz	○
<b>P10 Simple PLC and multi-step speed control</b>				
P10.00	Simple PLC mode	0: Stop after running once. The VFD has to be commanded again after finishing a cycle. 1: Run at the final value after running once. After finishing a cycle, the VFD will keep the running frequency and direction of the last run.	0	○

Function code	Name	Description	Default value	Modify
		2: Cyclic running. The VFD will keep on running, and the VFD does not stop until receiving a stop command.		
P10.01	Simple PLC memory selection	0: Power loss without memory 1: Power loss with memory. The running stage and frequency of PLC are recorded at power loss.	0	<input type="radio"/>
P10.02	Multi-step speed 0	<p>For frequency setting, 100.0% corresponds to the max. output frequency <a href="#">P00.03</a>.</p> <p>When selecting simple PLC running, set <a href="#">P10.02–P10.33</a> to the running frequency and direction at each step.</p> <p><b>Note:</b> The multi-step sign determines the running direction of simple PLC. The negative value means reverse running.</p>	0.0%	<input type="radio"/>
P10.03	Running time of step 0		0.0s	<input type="radio"/>
P10.04	Multi-step speed 1		0.0%	<input type="radio"/>
P10.05	Running time of step 1		0.0s	<input type="radio"/>
P10.06	Multi-step speed 2		0.0%	<input type="radio"/>
P10.07	Running time of step 2		0.0s	<input type="radio"/>
P10.08	Multi-step speed 3		0.0%	<input type="radio"/>
P10.09	Running time of step 3		0.0s	<input type="radio"/>
P10.10	Multi-step speed 4		0.0%	<input type="radio"/>
P10.11	Running time of step 4		0.0s	<input type="radio"/>
P10.12	Multi-step speed 5		0.0%	<input type="radio"/>
P10.13	Running time of step 5		0.0s	<input type="radio"/>
P10.14	Multi-step speed 6		0.0%	<input type="radio"/>
P10.15	Running time of step 6		0.0s	<input type="radio"/>
P10.16	Multi-step speed		0.0%	<input type="radio"/>

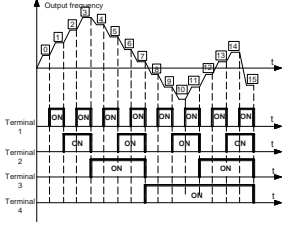
Function code	Name	Description	Default value	Modify																			
	7																						
P10.17	Running time of step 7	 <p>When terminals 1–4 are OFF, the frequency input method is selected through <a href="#">P00.06</a> or <a href="#">P00.07</a>. When at least one of terminals 1–4 are not OFF, multi-step speed running takes priority over keypad, analog, high-speed pulse, PLC, and communication frequency input.</p> <p>The start and stop of multi-step running are determined by <a href="#">P00.06</a>.</p>	0.0s	<input type="radio"/>																			
P10.18	Multi-step speed 8		0.0%	<input type="radio"/>																			
P10.19	Running time of step 8		0.0s	<input type="radio"/>																			
P10.20	Multi-step speed 9		0.0%	<input type="radio"/>																			
P10.21	Running time of step 9		0.0s	<input type="radio"/>																			
P10.22	Multi-step speed 10		0.0%	<input type="radio"/>																			
P10.23	Running time of step 10		0.0s	<input type="radio"/>																			
P10.24	Multi-step speed 11		0.0%	<input type="radio"/>																			
P10.25	Running time of step 11		<table border="1"> <tbody> <tr> <td>Trml1</td> <td>OFF</td> <td>ON</td> <td>OFF</td> <td>ON</td> <td>OFF</td> <td>ON</td> <td>OFF</td> <td>ON</td> </tr> <tr> <td>Trml2</td> <td>OFF</td> <td>OFF</td> <td>ON</td> <td>ON</td> <td>OFF</td> <td>OFF</td> <td>ON</td> <td>ON</td> </tr> </tbody> </table>	Trml1	OFF	ON	OFF	ON	OFF	ON	OFF	ON	Trml2	OFF	OFF	ON	ON	OFF	OFF	ON	ON	0.0s	<input type="radio"/>
Trml1	OFF		ON	OFF	ON	OFF	ON	OFF	ON														
Trml2	OFF		OFF	ON	ON	OFF	OFF	ON	ON														
P10.26	Multi-step speed 12	<table border="1"> <tbody> <tr> <td>Trml3</td> <td>OFF</td> <td>OFF</td> <td>OFF</td> <td>OFF</td> <td>ON</td> <td>ON</td> <td>ON</td> <td>ON</td> </tr> <tr> <td>Trml4</td> <td>OFF</td> <td>OFF</td> <td>OFF</td> <td>OFF</td> <td>OFF</td> <td>OFF</td> <td>OFF</td> <td>OFF</td> </tr> </tbody> </table>	Trml3	OFF	OFF	OFF	OFF	ON	ON	ON	ON	Trml4	OFF	OFF	OFF	OFF	OFF	OFF	OFF	OFF	0.0%	<input type="radio"/>	
Trml3	OFF	OFF	OFF	OFF	ON	ON	ON	ON															
Trml4	OFF	OFF	OFF	OFF	OFF	OFF	OFF	OFF															
P10.27	Running time of step 12	<table border="1"> <tbody> <tr> <td>Step</td> <td>0</td> <td>1</td> <td>2</td> <td>3</td> <td>4</td> <td>5</td> <td>6</td> <td>7</td> </tr> </tbody> </table>	Step	0	1	2	3	4	5	6	7	0.0s	<input type="radio"/>										
Step	0	1	2	3	4	5	6	7															
P10.28	Multi-step speed 13	<table border="1"> <tbody> <tr> <td>Trml1</td> <td>OFF</td> <td>ON</td> <td>OFF</td> <td>ON</td> <td>OFF</td> <td>ON</td> <td>OFF</td> <td>ON</td> </tr> <tr> <td>Trml2</td> <td>OFF</td> <td>OFF</td> <td>ON</td> <td>ON</td> <td>OFF</td> <td>OFF</td> <td>ON</td> <td>ON</td> </tr> </tbody> </table>	Trml1	OFF	ON	OFF	ON	OFF	ON	OFF	ON	Trml2	OFF	OFF	ON	ON	OFF	OFF	ON	ON	0.0%	<input type="radio"/>	
Trml1	OFF	ON	OFF	ON	OFF	ON	OFF	ON															
Trml2	OFF	OFF	ON	ON	OFF	OFF	ON	ON															
P10.29	Running time of step 13	<table border="1"> <tbody> <tr> <td>Trml3</td> <td>OFF</td> <td>OFF</td> <td>OFF</td> <td>OFF</td> <td>ON</td> <td>ON</td> <td>ON</td> <td>ON</td> </tr> <tr> <td>Trml4</td> <td>ON</td> <td>ON</td> <td>ON</td> <td>ON</td> <td>ON</td> <td>ON</td> <td>ON</td> <td>ON</td> </tr> </tbody> </table>	Trml3	OFF	OFF	OFF	OFF	ON	ON	ON	ON	Trml4	ON	ON	ON	ON	ON	ON	ON	ON	0.0s	<input type="radio"/>	
Trml3	OFF	OFF	OFF	OFF	ON	ON	ON	ON															
Trml4	ON	ON	ON	ON	ON	ON	ON	ON															
P10.30	Multi-step speed 14	<table border="1"> <tbody> <tr> <td>Step</td> <td>8</td> <td>9</td> <td>10</td> <td>11</td> <td>12</td> <td>13</td> <td>14</td> <td>15</td> </tr> </tbody> </table>	Step	8	9	10	11	12	13	14	15	0.0%	<input type="radio"/>										
Step	8	9	10	11	12	13	14	15															
P10.31	Running time of step 14	P10.(2n,1<n<17) setting range: -100.0–100.0%																					
P10.32	Multi-step speed 15	P10.(2n+1,1<n<17) setting range: 0.0–6553.5s(min)	0.0s	<input type="radio"/>																			
P10.33	Running time of step 15		0.0%	<input type="radio"/>																			
P10.33	Running time of step 15		0.0s	<input type="radio"/>																			
P10.34	ACC/DEC time	See the following:	0x0000	<input type="radio"/>																			



Function code	Name	Description	Default value	Modify																																																																																																																							
P10.35	selection for steps 0–7 in simple PLC running	<table border="1"> <thead> <tr> <th>Function code</th> <th>Binary</th> <th>Step</th> <th>ACC/DEC time1</th> <th>ACC/DEC time2</th> <th>ACC/DEC time3</th> <th>ACC/DEC time4</th> </tr> </thead> <tbody> <tr> <td></td> <td>BIT1 BIT0</td> <td>0</td> <td>00</td> <td>01</td> <td>10</td> <td>11</td> </tr> <tr> <td></td> <td>BIT3 BIT2</td> <td>1</td> <td>00</td> <td>01</td> <td>10</td> <td>11</td> </tr> <tr> <td></td> <td>BIT5 BIT4</td> <td>2</td> <td>00</td> <td>01</td> <td>10</td> <td>11</td> </tr> <tr> <td></td> <td>BIT7 BIT6</td> <td>3</td> <td>00</td> <td>01</td> <td>10</td> <td>11</td> </tr> <tr> <td>P10.34</td> <td>BIT9 BIT8</td> <td>4</td> <td>00</td> <td>01</td> <td>10</td> <td>11</td> </tr> <tr> <td></td> <td>BIT11 BIT10</td> <td>5</td> <td>00</td> <td>01</td> <td>10</td> <td>11</td> </tr> <tr> <td></td> <td>BIT13 BIT12</td> <td>6</td> <td>00</td> <td>01</td> <td>10</td> <td>11</td> </tr> <tr> <td></td> <td>BIT15 BIT14</td> <td>7</td> <td>00</td> <td>01</td> <td>10</td> <td>11</td> </tr> <tr> <td>P10.35</td> <td>BIT1 BIT0</td> <td>8</td> <td>00</td> <td>01</td> <td>10</td> <td>11</td> </tr> <tr> <td></td> <td>BIT3 BIT2</td> <td>9</td> <td>00</td> <td>01</td> <td>10</td> <td>11</td> </tr> <tr> <td></td> <td>BIT5 BIT4</td> <td>10</td> <td>00</td> <td>01</td> <td>10</td> <td>11</td> </tr> <tr> <td></td> <td>BIT7 BIT6</td> <td>11</td> <td>00</td> <td>01</td> <td>10</td> <td>11</td> </tr> <tr> <td></td> <td>BIT9 BIT8</td> <td>12</td> <td>00</td> <td>01</td> <td>10</td> <td>11</td> </tr> <tr> <td></td> <td>BIT11 BIT10</td> <td>13</td> <td>00</td> <td>01</td> <td>10</td> <td>11</td> </tr> <tr> <td></td> <td>BIT13 BIT12</td> <td>14</td> <td>00</td> <td>01</td> <td>10</td> <td>11</td> </tr> <tr> <td></td> <td>BIT15 BIT14</td> <td>15</td> <td>00</td> <td>01</td> <td>10</td> <td>11</td> </tr> </tbody> </table>	Function code	Binary	Step	ACC/DEC time1	ACC/DEC time2	ACC/DEC time3	ACC/DEC time4		BIT1 BIT0	0	00	01	10	11		BIT3 BIT2	1	00	01	10	11		BIT5 BIT4	2	00	01	10	11		BIT7 BIT6	3	00	01	10	11	P10.34	BIT9 BIT8	4	00	01	10	11		BIT11 BIT10	5	00	01	10	11		BIT13 BIT12	6	00	01	10	11		BIT15 BIT14	7	00	01	10	11	P10.35	BIT1 BIT0	8	00	01	10	11		BIT3 BIT2	9	00	01	10	11		BIT5 BIT4	10	00	01	10	11		BIT7 BIT6	11	00	01	10	11		BIT9 BIT8	12	00	01	10	11		BIT11 BIT10	13	00	01	10	11		BIT13 BIT12	14	00	01	10	11		BIT15 BIT14	15	00	01	10	11	0x0000	○
	Function code	Binary	Step	ACC/DEC time1	ACC/DEC time2	ACC/DEC time3	ACC/DEC time4																																																																																																																				
		BIT1 BIT0	0	00	01	10	11																																																																																																																				
		BIT3 BIT2	1	00	01	10	11																																																																																																																				
		BIT5 BIT4	2	00	01	10	11																																																																																																																				
		BIT7 BIT6	3	00	01	10	11																																																																																																																				
	P10.34	BIT9 BIT8	4	00	01	10	11																																																																																																																				
		BIT11 BIT10	5	00	01	10	11																																																																																																																				
		BIT13 BIT12	6	00	01	10	11																																																																																																																				
		BIT15 BIT14	7	00	01	10	11																																																																																																																				
	P10.35	BIT1 BIT0	8	00	01	10	11																																																																																																																				
		BIT3 BIT2	9	00	01	10	11																																																																																																																				
		BIT5 BIT4	10	00	01	10	11																																																																																																																				
		BIT7 BIT6	11	00	01	10	11																																																																																																																				
		BIT9 BIT8	12	00	01	10	11																																																																																																																				
		BIT11 BIT10	13	00	01	10	11																																																																																																																				
		BIT13 BIT12	14	00	01	10	11																																																																																																																				
		BIT15 BIT14	15	00	01	10	11																																																																																																																				
			<p>After you select the corresponding acceleration/deceleration time, convert the combined 16-bit binary to a decimal, and then set the corresponding function codes.</p> <p>Setting range: -0x0000–0xFFFF</p>																																																																																																																								
	P10.36	PLC restart mode	<p>0: Restart from the first step; stop during running (caused by the stop command, fault or power loss), run from the first step after restart.</p> <p>1: Continue to run from the stop frequency; stop during running (cause by stop command and fault), the VFD will record the running time automatically, enter the step after restart and keep the remaining running at the set frequency.</p>	0	◎																																																																																																																						
P10.37	Multi-step time unit selection	<p>0: Seconds; the running time of all steps is counted by second</p> <p>1: Minutes; the running time of all steps is counted by minute</p>	0	◎																																																																																																																							
<b>P11 Protective parameters</b>																																																																																																																											
P11.00	Phase loss protection	0x000–0x111 LED ones: Phase loss software protection on the	010 (2.2kW and	○																																																																																																																							

Function code	Name	Description	Default value	Modify				
		input side 0: Disable 1: Enable LED tens: Phase loss software protection on the output side 0: Disable 1: Enable LED hundreds: Phase loss hardware protection on the input side 0: Disable 1: Enable	lower)  110 (4kW and higher)					
P11.01	Frequency decreasing at sudden power loss	0: Disable 1: Enable	0	<input type="radio"/>				
P11.02	Frequency decreasing rate at sudden power loss	<p>Setting range: 0.00Hz/s–<a href="#">P00.03</a> (Max. output frequency)</p> <p>After the power loss of the grid, the bus voltage drops to the sudden frequency decreasing point, the VFD begins to decrease the running frequency according to <a href="#">P11.02</a>, to make the VFD generate power again. The returned power can maintain the bus voltage to ensure normal running of the VFD until the recovery of power.</p> <table border="1" data-bbox="363 936 769 1125"> <thead> <tr> <th>Voltage class</th> <th>Frequency decreasing point at sudden power loss</th> </tr> </thead> <tbody> <tr> <td>380V</td> <td>460V</td> </tr> </tbody> </table> <p><b>Note:</b></p> <ul style="list-style-type: none"> <li>● Adjust the parameter properly to prevent the stop caused by VFD protection during the switching of the grid.</li> <li>● Prohibit input phase loss protection to enable this function.</li> </ul>	Voltage class	Frequency decreasing point at sudden power loss	380V	460V	10.00 Hz/s	<input type="radio"/>
Voltage class	Frequency decreasing point at sudden power loss							
380V	460V							

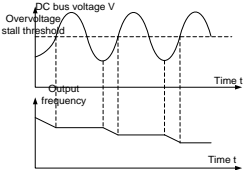
Function code	Name	Description	Default value	Modify
P11.03	Overvoltage stall protection	0: Disallow 1: Allow 	1	<input type="radio"/>
P11.04	Overvoltage stall protection threshold	110–150%(standard bus voltage)(380V)	130%	<input type="radio"/>
		110–150%(standard bus voltage)(220V)	120%	
P11.05	Current limit action	<a href="#">P11.05</a> setting range: Ones: Current limit action selection	0x01	<input checked="" type="radio"/>
P11.06	Automatic current limit threshold	0: Invalid 1: Always valid 2: Invalid during DEC	For the G type: 160.0%	<input checked="" type="radio"/>
P11.07	Frequency decreasing rate during current limit	Tens: Hardware current limit overload alarm selection 0: Valid 1: Invalid The actual increasing rate of the motor rotation speed is less than the rate of output frequency because of the heavy load during ACC running. It is necessary to take measures to avoid overcurrent fault and the VFD trips. During the running of the VFD, this function will detect the output current and compare it with the limit threshold <a href="#">P11.06</a> . If it exceeds the threshold, the VFD will run at stable frequency in ACC running, or the VFD will derate to run during the constant running. If it exceeds the threshold continuously, the output frequency will keep on decreasing to the lower limit. If the output current is detected to be lower than the limit threshold, the VFD will accelerate to run.	10.00 Hz/s	<input checked="" type="radio"/>

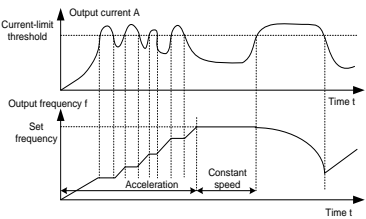
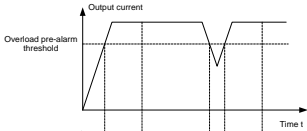
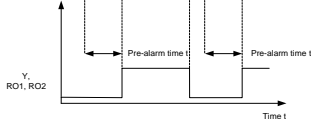
Function code	Name	Description	Default value	Modify
		 <p><a href="#">P11.05</a> setting range: 0x00–0x12  <a href="#">P11.06</a> setting range: 50.0–200.0%  <a href="#">P11.07</a> setting range: 0.00–50.00Hz/s</p>		
P11.08	VFD/motor OL/UL pre-alarm selection	If the output current of the VFD or motor is greater than <a href="#">P11.09</a> and the lasting time exceeds <a href="#">P11.10</a> , the overload alarm signal is output.	0x0000	<input type="radio"/>
P11.09	Overload pre-alarm detection threshold		150%	<input type="radio"/>
P11.10	Overload pre-alarm detection time	 <p><a href="#">P11.08</a> indicates whether to enable and define the overload pre-alarm of the VFD or motor.  Setting range: 0x0000–0x1131  LED ones:  0: Motor OL/UL pre-alarm, relative to the motor rated current  1: VFD OL/UL pre-alarm, relative to the VFD rated current  LED tens:</p>	1.0s	<input type="radio"/>

Function code	Name	Description	Default value	Modify
		<p>0: The VFD continues to work after OL/UL pre-alarm</p> <p>1: The VFD continues to work after underload pre-alarm and stops running upon an overload fault</p> <p>2: The VFD continues to work after overload pre-alarm and stops running upon an underload fault</p> <p>3. The VFD stops when OL/UL occurred.</p> <p>LED hundreds :</p> <p>0: Detect all the time</p> <p>1: Detect during constant speed running</p> <p>LED thousands: Overload integral function selection</p> <p>0: Overload integral is invalid</p> <p>1: Overload integral is valid</p> <p><a href="#">P11.09</a> setting range: <a href="#">P11.11</a>–200%</p> <p><a href="#">P11.10</a> setting range: 0.1–3600.0s</p>		
P11.11	Underload pre-alarm detection threshold	If the output current of the VFD or motor is less than <a href="#">P11.11</a> and the lasting time exceeds <a href="#">P11.12</a> , the underload alarm signal is output.	50%	<input type="radio"/>
P11.12	Underload pre-alarm detection time	<a href="#">P11.11</a> setting range: 0– <a href="#">P11.09</a> <a href="#">P11.12</a> setting range: 0.1–3600.0s	1.0s	<input type="radio"/>
P11.13	Fault output terminal action selection at a fault	<p>This function code is used to select the action of fault output terminals on undervoltage and fault reset.</p> <p>0x00–0x11</p> <p>LED ones:</p> <p>0: Act at an undervoltage fault</p> <p>1: Not act at an undervoltage fault</p> <p>LED tens:</p> <p>0: Act during the automatic reset period</p> <p>1: Not act during the automatic reset period</p>	0x00	<input type="radio"/>

Function code	Name	Description	Default value	Modify
P11.14	Speed deviation detection value	0.0–50.0%	10.0%	<input type="radio"/>
P11.15	Speed deviation detection time	<p>See the following figure.</p> <p>Setting range: 0.0–10.0s</p>	0.5s	<input type="radio"/>
P11.16	Extension function selection	<p>0x00–0x11</p> <p>LED ones: Automatic frequency drop selection at voltage drop</p> <p>0: Invalid</p> <p>1: Valid</p> <p>LED tens: Second ACC/DEC time selection</p> <p>0: Invalid</p> <p>1: Valid. When the running frequency exceeds <a href="#">P08.36</a>, ACC/DEC time is switched to the second ACC/DEC time.</p>	0x00	<input type="radio"/>
<b>P13 SM control</b>				
P13.13	Short circuit braking current	<p>When the VFD is starting, if <a href="#">P01.00</a>=0, set <a href="#">P13.14</a> to a non-zero value to begin short circuit braking.</p> <p>When the VFD is stopping, if the running frequency is less than <a href="#">P01.09</a>, set <a href="#">P13.15</a> to a non-zero value to begin short-circuit braking and then enter DC braking that lasts <a href="#">P01.12</a>. (For details, see the description of <a href="#">P01.09</a> - <a href="#">P01.12</a>.)</p> <p><a href="#">P13.13</a> setting range: 0.0–150.0% (VFD)</p> <p><a href="#">P13.14</a> setting range: 0.00–50.00s</p> <p><a href="#">P13.15</a> setting range: 0.00–50.00s</p>	0.0%	<input type="radio"/>
P13.14	Hold time of short circuit braking at start		0.00s	<input type="radio"/>
P13.15	Hold time of short circuit braking at stop		0.00s	<input type="radio"/>
<b>P14 Serial communication</b>				

Function code	Name	Description	Default value	Modify
P14.00	Local communication address	<p>Setting range: 1–247</p> <p>When the master is writing a frame, the communication address of the slave is set to 0; the broadcast address is the communication address. All slaves on the Modbus fieldbus can receive the frame, but the slaves do not need to answer.</p> <p>The local communication address is unique in the communication network. This is the fundamental for the point to point communication between the upper monitor and the VFD.</p> <p><b>Note:</b> The address of a slave cannot be set to 0. To prevent conflict, P14.00 is 1 by default, while F14.00 is 2 by default.</p>	1	<input type="radio"/>
P14.01	Communication baud rate	<p>This function code is used to set the data transmission rate between the upper monitor and the VFD.</p> <p>0: 1200BPS 1: 2400BPS 2: 4800BPS 3: 9600BPS 4: 19200BPS 5: 38400BPS 6: 57600BPS</p> <p><b>Note:</b> The baud rate between the upper monitor and the VFD must be the same. Otherwise, the communication fails. A greater baud rate indicates a higher communication speed.</p>	4	<input type="radio"/>
P14.02	Data bit check setting	<p>0: No check (N, 8, 1) for RTU 1: Even check (E, 8, 1) for RTU 2: Odd check (O, 8, 1) for RTU 3: No check (N, 8, 2) for RTU 4: Even check (E, 8, 2) for RTU 5: Odd check (O, 8, 2) for RTU 6: No check (N, 7, 1) for ASCII 7: Even check (E, 7, 1) for ASCII 8: Odd check (O, 7, 1) for ASCII</p>	1	<input type="radio"/>

Function code	Name	Description	Default value	Modify
		9: No check (N, 7, 2) for ASCII 10: Even check (E, 7, 2) for ASCII 11: Odd check (O, 7, 2) for ASCII 12: No check (N, 8, 1) for ASCII 13: Even check (E, 8, 1) for ASCII 14: Odd check (O, 8, 1) for ASCII 15: No check (N, 8, 2) for ASCII 16: Even check (E, 8, 2) for ASCII 17: Odd check (O, 8, 2) for ASCII		
P14.03	Communication response delay	0–200ms This function code indicates the time interval between when the VFD receives data and when the VFD sends a response to the upper monitor. If the delay is shorter than the system processing time, the delay is the system processing time. If the delay is longer than the system processing time, even though the data has been processed, the VFD does not send a response to the upper monitor until the delay is reached.	5	<input type="radio"/>
P14.04	Communication timeout time	0.0 (invalid), 0.1–60.0s When this function code is set to 0.0, the communication timeout time parameter is invalid. When this function code is set to a non-zero value, if the time interval between two communications exceeds the communication timeout time, the fault "RS485 communication fault" (CE) is reported. In common cases, it is set to 0.0. In systems which have continuous communication, you can monitor the communication condition by setting this function code.	0.0s	<input type="radio"/>
P14.05	Transmission fault processing	0: Alarm and stop freely 1: Not alarm and continue to run 2: Not alarm and stop according to the stop means (only under communication control) 3: Not alarm and stop according to the stop means (under all control modes)	0	<input type="radio"/>



Function code	Name	Description	Default value	Modify
P14.06	Communication processing action selection	0x000–0x111 LED ones: Responding to write operations 0: Yes 1: No LED tens: Communication encryption 0: Disable 1: Enable LED hundreds: User-defined communication command address 0: Invalid 1: Valid	0x000	<input type="radio"/>
P14.07	User-defined address for running commands	0x0000–0xffff	0x1000	<input type="radio"/>
P14.08	User-defined address for frequency setting	0x0000–0xffff	0x2000	<input type="radio"/>
P14.10	Keypad selection	0: The keypad display #1 inverter unit information (group P) 1: The keypad display #2 inverter unit information (group F) <b>Note:</b> F14.10 is set to 1 by default.	0	<input type="radio"/>
P14.11	Digital input interaction control	0: Invalid 1: Valid When it is invalid, #1 inverter unit cannot use input of S5–S8, and #2 inverter unit cannot use input of S1–S4. When it is valid, interaction control is implemented for the input terminals for which P05.01–P05.08 are 0. For example, if F05.05 is 0 (#2 inverter unit does not occupy S5), #1 inverter unit can use the input of S5. Similarly, if F05.01 is 0 (#1 inverter unit does not occupy S1), #2 inverter unit can use the input of S1.	0	<input type="radio"/>

Function code	Name	Description	Default value	Modify
P14.12	Relay output interaction control	<p>0: Invalid 1: Valid</p> <p>When it is invalid, #1 inverter unit cannot control output of RO2, and #2 inverter unit cannot control output of RO1.</p> <p>When it is valid, if F06.04 is invalid (#2 inverter unit does not control output of RO2), #1 inverter unit can control output of RO2; similarly, if F06.03 is invalid (#1 inverter unit does not control output of RO1), #2 inverter unit can control output of RO1.</p>	0	<input type="radio"/>
P14.13	AI data interaction control	<p>0: Invalid 1: Valid</p> <p>When it is invalid, #1 inverter unit cannot read AI3 of #2 inverter unit, and #2 inverter unit cannot read AI2 of #1 inverter unit.</p> <p>When it is valid, #1 inverter unit can read AI3 of #2 inverter unit, and #2 inverter unit can read AI2 of #1 inverter unit.</p>	0	<input type="radio"/>
P14.14	AO data interaction control	<p>0: Invalid 1: Valid</p> <p>When it is invalid, #1 inverter unit cannot control output of AO2, and #2 inverter unit cannot control output of AO1.</p> <p>When it is valid, if F06.15 is invalid (#2 inverter unit does not control output of AO2), #1 inverter unit can control output of AO2; similarly, if F06.14 is invalid (#1 inverter unit does not control output of AO1), #2 inverter unit can control output of AO1.</p>	0	<input type="radio"/>
P14.15	Communication interaction action selection at fault	<p>0: The local device keeps running when another device encounters a fault.</p> <p>1: The local device coasts to stop and displays the fault code when another device encounters a fault.</p> <p>When it is 0, if the dual system is running properly, but #2 inverter unit (or #1 inverter unit) encounters a fault, #1 inverter unit (or #2 inverter unit) keeps running.</p>	0	<input type="radio"/>

Function code	Name	Description	Default value	Modify
		When it is 1, if the dual system is running properly, but #2 inverter unit (or #1 inverter unit) encounters a fault, #1 inverter unit (or #2 inverter unit) coasts to stop and displays the fault code of #2 inverter unit (or #1 inverter unit).		
P14.16	Reserved			
P14.17	LIN communication fault timeout time	0.0 (invalid), 0.1–60.0s	0.0s	○
<b>P17 Status viewing</b>				
P17.00	Set frequency	This function code displays the set frequency of the VFD. Range: 0.00Hz– <a href="#">P00.03</a>		●
P17.01	Output frequency	This function code displays the present output frequency of the VFD. Range: 0.00Hz– <a href="#">P00.03</a>		●
P17.02	Ramp reference frequency	This function code displays the present ramp reference frequency of the VFD. Range: 0.00Hz– <a href="#">P00.03</a>		●
P17.03	Output voltage	This function code displays the present output voltage of the VFD. Range: 0–1200V		●
P17.04	Output current	This function code displays the present output current of the VFD. Range: 0.0–5000.0A		●
P17.05	Motor rotation speed	This function code displays the motor rotation speed. Range: 0–65535RPM		●
P17.06	Torque current	This function code displays the present torque current of the VFD. Range: 0.0–5000.0A		●
P17.07	Exciting current	This function code displays the present exciting current of the VFD. Range: 0.0–5000.0A		●
P17.08	Motor power	This function code displays the motor power, for which 100.0% is relative to the motor rated		●

Function code	Name	Description	Default value	Modify
		power. A positive value indicates electrical driving state, and a negative value indicates electricity generation state. Range: -300.0–300.0% (relative to the motor rated power)		
P17.09	Output torque	This function code displays the present output torque of the VFD, for which 100.0% is relative to the motor rated torque. A positive value indicates electrical driving state, and a negative value indicates electricity generation state. Range: -250.0–250.0%		●
P17.10	Estimated motor frequency	This function code displays the estimated motor rotor frequency in open loop vector control. Range: 0.00– <a href="#">P00.03</a>		●
P17.11	DC bus voltage	This function code displays the present DC bus voltage of the VFD. Range: 0.0–2000.0V		●
P17.12	Digital input terminal status	This function code displays the present digital input terminal status of the VFD. Range: 0000–00FF		●
P17.13	Digital output terminal status	This function code displays the present digital output terminal status of the VFD. Range: 0000–000F		●
P17.14	Digital adjustment	This function code displays the adjustment set through the keypad. Range: 0.00Hz– <a href="#">P00.03</a>		●
P17.15	Torque reference	This function code displays torque reference, the percentage of the motor rated torque. Range: -300.0%–300.0% (of the motor rated current)		●
P17.16	Linear speed	This function code displays the present linear speed of the VFD. Range: 0–65535		●
P17.17	Reserved			●
P17.18	Counting value	This function code displays the present counting value of the VFD. Range: 0–65535		●

Function code	Name	Description	Default value	Modify
P17.20	AI2 input voltage	This function code displays the AI2 input signal. Range: 0.00–10.00V		●
P17.21	AI3 input voltage	This function code displays the AI3 input signal. Range: -10.00–10.00V		●
P17.23	PID reference value	This function code displays the PID reference value. Range: -100.0–100.0%		●
P17.24	PID feedback value	This function code displays the PID feedback value. Range: -100.0–100.0%		●
P17.25	Motor power factor	This function code displays the motor power factor. Range: -1.00–1.00		●
P17.26	Present running time	This function code displays the present running time of the VFD. Range: 0–65535min		●
P17.27	Simple PLC and present step of multi-step speed	This function code displays the simple PLC and present step of multi-step speed. Range: 0–15		●
P17.28	ASR controller output	This function code displays the ASR controller output in vector control, relative to a percentage of the motor rated torque. Range: -300.0%–300.0% (of the motor rated current)		●
P17.29–P17.31	Reserved			
P17.32	Magnetic flux linkage	This function code displays the magnetic flux linkage of the motor. Range: 0.0%–200.0%		●
P17.33	Exciting current reference	This function code displays the exciting current reference in vector control. Range: -3000.0–3000.0A		●
P17.34	Torque current reference	This function code displays the torque current reference in vector control. Range: -3000.0–3000.0A		●
P17.35	AC input current	This function code displays the incoming line current on the AC input side.		●

Function code	Name	Description	Default value	Modify
		Range: 0.0–5000.0A		
P17.36	Output torque	This function code displays the output torque. A positive value indicates electrical driving state, and a negative value indicates electricity generation state. Range: -3000.0Nm–3000.0Nm		●
P17.37	Motor overload counting value	0–100 (When 100 is displayed, fault OL1 is reported)		●
P17.38	PID output value	This function code displays the PID output value. Range: -100.00–100.00%		●
P17.39	Parameter download error	0.00–99.99	0.00	●
P17.40	Process PID proportional gain	0.00–100.00		●
P17.41	Process PID integral time	0.00–10.00s		●
P17.42	Process PID differential time	0.00–10.00s		●

## 5.2 Function terminal reuse

Goodrive18 series two-in-one VFD is configured with two channels of inverter output. The use of function terminals is more flexible — function terminals can be reused, meeting requirements in different application scenarios. The default configuration of function terminals has been described in section 3.1.8. If you want to modify the configuration, you can set function group P/F14 for reassignment on digital input, analog input, analog output, and relay output. For example, the following describes how to reassign S5 (that has been assigned to #2 inverter unit) to #1 inverter unit.

Step 1 Set F05.05 to 0 (no function).

Step 2 Set P14.11 to 1 (valid) to enable the digital input interaction control of group P.

Step 3 Set P00.01 to 1 and set P05.05 to the required control means, for example, 1 (forward running).

**Note:** If F05.05 is not 0, S5 is still used by group F, and the setting for group P is not identified.

You can use the same method to perform reassignment on analog input, analog output, and relay output.

## 6 Troubleshooting

### 6.1 Fault prevention

This chapter describes how to perform preventive maintenance on the VFD.

#### 6.1.1 Periodical maintenance

If the VFD is installed in an environment that meets requirements, only a little maintenance workload is needed. The following table describes the routine maintenance periods recommended by INVT. For more detailed information on maintenance, please contact us.

Subject		Item	Method	Criterion
Ambient environment		Check the temperature, and humidity, and whether there is vibration, dust, gas, oil spray, and water droplets in the environment.	Visual inspection, and use instruments for measurement.	The requirements stated in this manual are met.
		Check whether there are foreign matters, such as tools, or dangerous substances placed nearby.	Visual inspection	There are no tools or dangerous substances placed nearby.
Voltage		Check the voltage of the main circuit and control circuit.	Use multimeters or other instruments for measurement.	The requirements stated in this manual are met.
Keypad		Check the display of information.	Visual inspection	The characters are displayed properly.
		Check whether characters are not completely displayed.	Visual inspection	The requirements stated in this manual are met.
Main circuit	Common	Check whether the bolts loose or come off.	Screw them up.	No exception occurs.
		Check whether the machine is deformed, cracked, or	Visual inspection	No exception occurs.

Subject	Item	Method	Criterion
	damaged, or their color changes due to overheating and aging.		
	Check whether there are stains and dust attached.	Visual inspection	No exception occurs. <b>Note:</b> Copper bar decoloring does not indicate performance deterioration.
Conductor and wire	Check whether the conductors are deformed or their color change due to overheat.	Visual inspection	No exception occurs.
	Check whether the wire sheaths are cracked or their color changes.	Visual inspection	No exception occurs.
Terminal block	Check whether there is damage.	Visual inspection	No exception occurs.
Filter capacitor	Check whether there is electrolyte leakage, discoloration, cracks, and chassis expansion.	Visual inspection	No exception occurs.
	Check whether the safety valves are released.	Determine the service life based on the maintenance information, or measure them through electrostatic capacity.	No exception occurs.



Subject		Item	Method	Criterion
	Resistor	Check whether the electrostatic capacity is measured as required.	Use instruments to measure the capacity.	Electrostatic capacity $\geq$ initial value * 0.85
		Check whether there is displacement caused due to overheat.	Olfactory and visual inspection	No exception occurs.
	Check whether the resistors are disconnected.	Visual inspection, or remove one end of the connection cable and use a multimeter for measurement.	Resistance range: $\pm 10\%$ (of the standard resistance)	
	Transformer and reactor	Check whether there is unusual vibration sounds or smells.	Auditory, olfactory, and visual inspection	No exception occurs.
	Electromagnetic contactor and relay	Check whether there are vibration sounds in the workshop.	Auditory inspection	No exception occurs.
		Check whether the contacts are in good contact.	Visual inspection	No exception occurs.
Control circuit	Control PCB, connector	Check whether the screws and connectors loose.	Screw them up.	No exception occurs.
		Check whether there is unusual smell or discoloration.	Olfactory and visual inspection	No exception occurs.
		Check whether there are cracks, damage, deformation, or rust.	Visual inspection	No exception occurs.

Subject		Item	Method	Criterion
		Check whether there is electrolyte leakage or deformation.	Visual inspection, and determine the service life based on the maintenance information.	No exception occurs.
Cooling system	Cooling fan	Check whether there are unusual sounds or vibration.	Auditory and visual inspection, and turn the fan blades with your hand.	The rotation is smooth.
		Check whether the bolts loose.	Screw them up.	No exception occurs.
		Check whether there is decoloration caused due to overheat.	Visual inspection, and determine the service life based on the maintenance information.	No exception occurs.
	Ventilation duct	Check whether there are foreign matters blocking or attached to the cooling fan, air inlets, or air outlets.	Visual inspection	No exception occurs.

### 6.1.2 Cooling fan

The service life of the cooling fan of the VFD is longer than 25,000 hours. The actual service life of the cooling fan is related to the use of the VFD and the temperature in the ambient environment.

You can view the running duration of the VFD through [P07.14](#) (Accumulative running time).

The increase of the bearing noise indicates a fan fault. If the VFD is applied in a key position, replace the fan once the fan starts to generate unusual noise. You can purchase spare parts of fans from INVT.



- ◇ Read the safety precautions carefully and follow the instructions to perform operations. Otherwise, device damage or physical injuries or even death.

Step 1 Stop the VFD, disconnect the AC power supply, and wait a time no shorter than the wait time designated on the VFD.

Step 2 Lever the fan holder off the VFD frame with a screwdriver and lift the hinged fan holder slightly upward from its front edge. Open the cable clamp to loose the fan cable.

Step 3 Disconnect the fan cable. Remove the installation bracket.

Step 4 Install a new fan in the VFD in the reverse steps. Ensure that the air direction of the fan is consistent with that of the VFD, as shown in the following figure.

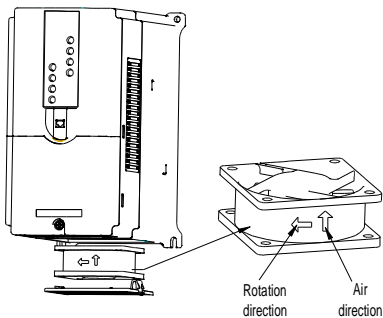

Figure 6.1 Fan maintenance for Goodrive18 series VFD

Step 5 Power on the VFD.

### 6.1.3 Capacitor

#### 6.1.3.1 Capacitor reforming

If the VFD has been left unused for a long time, you need to follow the instructions to reform the DC bus capacitor before the reuse. The storage time is calculated from the date the VFD is delivered.

Storage time	Operation instruction
Less than 1 year	No charging is required.
1 to 2 years	The power of the VFD has been on for 1 hour before the first running.
2 to 3 years	Use a voltage controlled power supply to charge the VFD: <ul style="list-style-type: none"> <li>• Apply 25% of the rated voltage for 30 minutes</li> <li>• Apply 50% of the rated voltage for 30 minutes</li> <li>• Apply 75% of the rated voltage for 30 minutes</li> <li>• Apply 100% of the rated voltage for 30 minutes</li> </ul>
More than 3 years	Use a voltage controlled power supply to charge the VFD: <ul style="list-style-type: none"> <li>• Apply 25% of the rated voltage for 2 hours</li> <li>• Apply 50% of the rated voltage for 2 hours</li> <li>• Apply 75% of the rated voltage for 2 hours</li> <li>• Apply 100% of the rated voltage for 2 hours</li> </ul>

The method for using a voltage controlled power supply to charge the VFD is described as follows:

The selection of a voltage controlled power supply depends on the power supply of the VFD. For VFDs with an incoming voltage of 1PH/3PH 230V AC, you can use a 220VAC/2A voltage regulator. Both 1PH and 3PH VFDs can be charged with a 1PH voltage controlled power supply (connecting L+ to R, and N to S or T). All the DC bus capacitors share one rectifier, and therefore they are all charged.

For a high voltage VFD, ensure that the voltage requirement (for example, 380V) is met during charging. Capacitor charging requires little current, and therefore you can use a small-capacity power supply (2A is sufficient).

#### 6.1.3.2 Electrolytic capacitor replacement

	<ul style="list-style-type: none"> <li>✧ Read the safety precautions carefully and follow the instructions to perform operations. Otherwise, device damage or physical injuries or even death may result.</li> </ul>
---	--

The electrolytic capacitor inside the VFD must be replaced if the service time exceeds 35,000 hours. For details about the replacement, contact the local INVT office.

#### 6.1.4 Power cable

	<ul style="list-style-type: none"> <li>✧ Read the safety precautions carefully and follow the instructions to perform operations. Otherwise, device damage or physical injuries or even death may result.</li> </ul>
--	--

Step 1 Stop the VFD, disconnect the power supply, and wait a time no shorter than the wait time designated on the VFD.

Step 2 Check the power cable connection and ensure the firmness.

Step 3 Power on the VFD.

## 6.2 Fault handling



✧ Only well-trained and qualified professionals are allowed to perform the work in this section. Follow the instructions in "Safety precautions".

### 6.2.1 Alarm and fault indication

When the **TRIP** indicator is on, the alarm or fault code displayed on the keypad indicates that an exception occurs on the VFD. The function codes from [P07.27](#) to [P07.32](#) record the types of the last six faults. The function codes from [P07.33](#) to [P07.40](#), [P07.41](#) to [P07.48](#), and [P07.49](#) to [P07.56](#) record the running data of the VFD at the last three faults, respectively. You can find out causes and solutions for most of the alarms or faults based on the information provided in this chapter. If you cannot find out the cause of an alarm or fault, contact the local INVT office.

### 6.2.2 Fault reset

The VFD can be reset by pressing the keypad key **STOP/RST**, through digital input, or by cutting off the VFD power supply. When the fault has been removed, the motor can be restarted.

### 6.2.3 Faults and solutions

Do as follows after a VFD fault occurs:

Step 1 Check whether the keypad display is normal. If not, contact the local INVT office.

Step 2 If there is no exception, check the corresponding fault record parameters in P07 to find the real state when the fault occurred.

Step 3 See the following table for a detailed solution.

Step 4 Eliminate the fault or ask for technical support.

Step 5 Ensure the fault is handled, and carry out fault reset to run the VFD.

#### Note:

- If Goodrive18 series two-in-one VFD encounters a fault, the keypad prefixes the fault code with "P-" or "F-" to distinguish whether #1 inverter unit (group P) or #2 inverter unit (group F) encounters a fault. If a fault code contains four digits by default, the "-" sign may be deleted depending on the fault code length. For example, the PIDE fault on #1 inverter unit is displayed as "PPIDE", while the OV1 fault on #2 inverter unit is displayed as "F-OV1". In addition, there is no distinguishing measure for the LInCE communication fault.
- When one inverter unit encounters a fault, you can choose whether to enable the other inverter unit to report the fault and stop by setting the function codes P14.15 and F14.15.

When both inverter units encounter faults, each inverter unit shows the respective fault.

<b>Fault code</b>	<b>Fault type</b>	<b>Possible cause</b>	<b>Solutions</b>
OV1	ACC overvoltage	<p>The input voltage is abnormal; There is large energy feedback; No braking components; Braking energy is not open.</p>	<p>Check the input power; Check if the DEC time of the load is too short or the VFD starts during the rotation of the motor or it needs to increase the energy consumption components; Install the braking components; Check the setting of related function codes.</p>
OV2	DEC overvoltage		
OV3	Constant-speed overvoltage		
OC1	ACC overcurrent	<p>The acceleration or deceleration is too fast; The voltage of the grid is too low; The power of the VFD is too low; The load transients or is abnormal; The grounding is short circuited or the output is phase loss; There is strong external interference; The overvoltage stall protection is not open.</p>	<p>Increase the ACC time; Check the input power; Select the VFD with a larger power; Check if the load is short circuited (the grounding short circuited or the wire short circuited) or the rotation is not smooth; Check the output configuration; Check if there is strong interference; Check the setting of related function codes.</p>
OC2	DEC overcurrent		
OC3	Constant-speed overcurrent		
UV	Bus under-voltage	<p>The voltage of the power supply is too low.</p>	<p>Check the input power of the supply line.</p>
OL1	Motor overload	<p>The voltage of the power supply is too low; The motor setting rated current is incorrect; The motor stall or load transients is too strong.</p>	<p>Check the power of the supply line; Reset the rated current of the motor; Check the load and adjust the torque lift.</p>

Fault code	Fault type	Possible cause	Solutions
OL2	VFD overload	The acceleration is too fast; Reset the rotating motor; The voltage of the power supply is too low; The load is too heavy; The motor power is too large, and the power of the VFD is too small.	Increase the ACC time; Avoid the restarting after stopping; Check the power of the supply line; Select a VFD with bigger power; Select a proper motor.
SPI	Input phase loss	Phase loss or fluctuation of input R, S, T	Check input power; Check installation distribution.
SPO	Output phase loss	U, V, W phase loss input (or serious asymmetrical three phase of the load)	Check the output distribution; Check the motor and cable.
OH2	Inverter module overheat	Air duct jam or fan damage; Ambient temperature is too high; The time of overload running is too long.	Dredge the vent duct or replace the fan; Lower the ambient temperature.
EF	External fault	SI external fault input terminals action	Check the external device input
CE	RS485 communication error	The baud rate setting is incorrect; Fault occurs to the communication wiring; The communication address is wrong; There is strong interference to the communication.	Set proper baud rate; Check the communication connection distribution; Set proper communication address; Change or replace the connection distribution or improve the anti-interference capability.
ItE	Current detection fault	The control board connector is in poor contact; An exception occurs on the magnifying circuit.	Check the connector and re-plug Change the main control board

Fault code	Fault type	Possible cause	Solutions
tE	Motor autotuning fault	The motor capacity does not comply with the VFD capability; The rated parameter of the motor does not set correctly; The offset between the parameters from autotune and the standard parameter is huge; Autotune overtime.	Change the VFD mode; Set the rated parameter according to the motor name plate; Empty the motor load; Check the motor connection and set the parameter; Check if the upper limit frequency is above 2/3 of the rated frequency.
EEP	EEPROM fault	Error of controlling the write and read of the parameters; Damage to EEPROM.	Press <b>STOP/RST</b> to reset; Change the main control board.
PIDE	PID feedback fault	PID feedback offline; PID feedback source disappear.	Check the PID feedback signal; Check the PID feedback source.
END	Time reach of factory setting	The actual running time of the VFD is above the internal setting running time.	Ask for the supplier and adjust the setting running time.
OL3	Electrical overload	The VFD will report overload pre-alarm according to the set value.	Check the load and the overload pre-alarm threshold.
PCE	Keypad communication error	The keypad is not in good connection or offline; The keypad cable is too long and there is strong interference; Part of the communication circuits of the keypad or main board have fault.	Check the keypad cable and ensure it is normal; Check the environment and eliminate the interference source; Change hardware and ask for maintenance service.



Fault code	Fault type	Possible cause	Solutions
UPE	Parameter upload error	The keypad is not in good connection or offline; The keypad cable is too long and there is strong interference; Part of the communication circuits of the keypad or main board have fault.	Check the environment and eliminate the interference source; Change hardware and ask for maintenance service; Change hardware and ask for maintenance service.
DNE	Parameter download error	The keypad is not in good connection or offline; The keypad cable is too long and there is strong interference; Data storage error in keypad.	Check the environment and eliminate the interference source; Change hardware and ask for maintenance service; Back up data in the keypad again.
ETH1	To-ground shortcircuit fault 1	The output of the VFD is short circuited with the ground; There is fault in the current detection circuit; There is a great difference between the actual motor power setting and the VFD power.	Check if the connection of the motor is normal or not; Change the hall; Change the main control board; Reset the correct motor parameter; Check whether motor power parameters in P02 group is consistent with the motor power actually used.
ETH2	To-ground shortcircuit fault 2		
LL	Electronic underload fault	The VFD will report the underload pre-alarm according to the set value.	Check the load and the underload pre-alarm point.
LInCE	LIN communication fault	LIN communication fault time exceeds the timeout time.	Increase the LIN communication timeout time P/F14.17 to a greater value. Change a new control board.

**6.2.4 Other status**

<b>Fault code</b>	<b>Fault type</b>	<b>Possible cause</b>	<b>Solutions</b>
P.oFF	System power off	System power off or low DC voltage	Check whether the input voltage is normal.

## 7 Communication

### 7.1 Modbus protocol introduction

Modbus is a software protocol, a common language used in electronic controllers. By using this protocol, a controller can communicate with other devices through transmission lines (such as RS485). It is a general industrial standard. With this standard, control devices produced by different manufacturers can be connected to form an industrial network and be monitored in a centralized way.

The Modbus protocol provides two transmission modes, namely American Standard Code for Information Interchange (ASCII) and remote terminal units (RTU). On one Modbus network, all the devices must be consistent in transmission modes, baud rates, data bits, check bits, stop bits, and other basic parameters.

A Modbus network is a control network with one master and multiple slaves, that is, on one Modbus network, there is only one device serving as the master, and other devices are the slaves. The master means the device which has active talking right to sent message to Modbus network for the controlling and inquiring to other devices. The slave means the passive device which sends data message to the Modbus network only after receiving the controlling or inquiring message (command) from the master (response). After the master sends message, there is a period of time left for the controlled or inquired slaves to response, which ensures there is only one slave sends message to the master at a time for preventing signal conflicts.

Generally, you can set the PC, PLC, IPC or HMI as the master to realize centralized control. Setting a certain device as the master is a convention other than setting by a button or a switch or the device uses a special message format. For example, if you click the command sending bottom when the upper monitor is running, the upper monitor can send a command message actively even it cannot receive the message from other devices. In this case, the upper monitor is the master. If the VFD is designed to send data only after receiving a command, the VFD is a slave.

The master can communicate with any single slave or with all slaves. For the single-visiting command, the slave must send back a response message; for the broadcasting message from the master, the slave does not need to send back a response message.

### 7.2 Application to the VFD

The VFD uses the Modbus RTU mode and communicates through the two-wire RS485 network.

**Note:** The local communication address ([P14.00](#)) is set to 1 for group P by default and it is set to 2 for group F by default. This function code in group P must be different from that in group F.

Otherwise, one of the two communication channels fail.

### 7.2.1 Two-wire RS485

The two-wire RS485 interface works in half-duplex mode and sends data signals in the differential transmission way, which is also referred to as balanced transmission. The two-wire RS485 interface uses a twisted pair, in which one wire is defined as A (+), and the other B (-). Generally, if the positive electrical level between the transmission drives A and B ranges from +2V to +6V, the logic is "1"; and if it ranges from -2V to -6V, the logic is "0".

On the VFD terminal block, the 485+ terminal corresponds to A, and 485- corresponds to B.

The communication baud rate ([P14.01](#)) indicates the number of bits sent in a second, and the unit is bit/s (bps). A higher baud rate indicates faster transmission and poorer anti-interference capability. When a twisted pair of 0.56mm (24 AWG) is used, the maximum transmission distance varies according to the baud rate, as described in the following table.

Baud rate	Max. transmission distance	Baud rate	Max. transmission distance	Baud rate	Max. transmission distance	Baud rate	Max. transmission distance
2400BPS	1800m	4800BPS	1200m	9600BPS	800m	19200BPS	600m

In long-distance RS485 communication, it is recommended that you use shielded cables, and use the shielding layer as the ground wire. When there are fewer devices and the transmission distance is short, the whole network works well without terminal load resistors. The performance, however, degrades as the distance increases. Therefore, it is recommended that you use a 120  $\Omega$  terminal resistor when the transmission distance is long.

#### 7.2.1.1 When one VFD is used

Figure 7.1 is the Modbus wiring diagram for the network with one VFD and PC. Generally, PCs do not provide RS485 interfaces, and therefore you need to convert an RS232 or USB interface of a PC to an RS485 interface through an adapter. Then, connect end A of the RS485 interface to the 485+ port on the terminal block of the VFD, and connect end B to the 485- port. It is recommended that you use shielded twisted pairs. When an RS232-RS485 adapter is used, the cable used to connect the RS232 interface of the PC and the adapter cannot be longer than 15m. Use a short cable when possible. It is recommended that you insert the adapter directly into the PC. Similarly, when a USB-RS485 adapter is used, use a short cable when possible.

When the wiring is completed, select the correct port (for example, COM1 to connect to the RS232-RS485 adapter) for the upper computer of the PC, and keep the settings of basic parameters such as communication baud rate and data check bit consistent with those of the VFD.

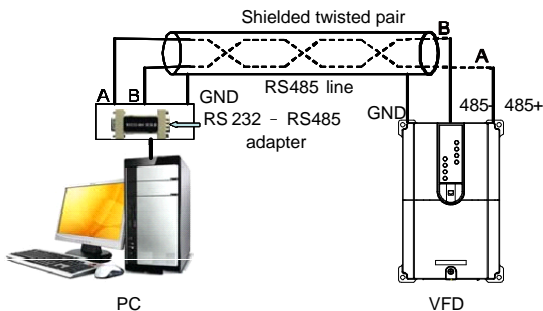

Figure 7.1 RS485 wiring diagram for the network with one VFD

### 7.2.1.2 When multiple VFDs are used

In the network with multiple VFDs, chrysanthemum connection and star connection are commonly used. According to the requirements of the RS485 industrial bus standards, all the devices need to be connected in chrysanthemum mode with one  $120\ \Omega$  terminal resistor on each end, as shown in Figure 7.2.

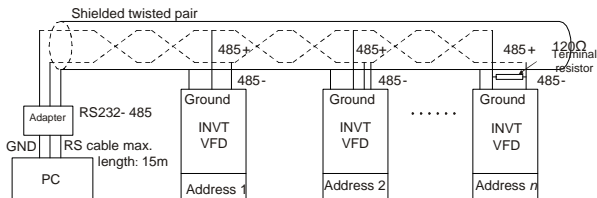

Figure 7.2 Practical application diagram of chrysanthemum connection

Figure 7.3 shows the start connection diagram. When this connection mode is adopted, each of the two devices that are farthest away from each other on the line must be configured with a terminal resistor (in this figure, the two devices are devices 1# and 15#).

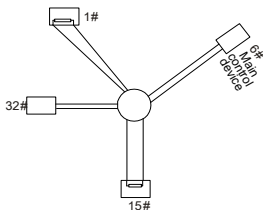

Figure 7.3 Star connection

Use shielded cable, if possible, in multi-VFD connection. The baud rates, data bit check settings, and other basic parameters of all the devices on the RS485 line must be set consistently, and addresses cannot be repeated.

## 7.2.2 RTU mode

### 7.2.2.1 RTU communication frame structure

When a controller is set to use the RTU communication mode on a Modbus network, every byte (8 bits) in the message includes 2 hexadecimal characters (each includes 4 bits). Compared with the ASCII mode, the RTU mode can send more data at the same baud rate.

#### Code system

- 1 start bit
- 7 or 8 data bits; the minimum valid bit is sent first. Each frame domain of 8 bits includes 2 hexadecimal characters (0–9, A–F).
- 1 odd/even check bit; this bit is not provided if no check is needed.
- 1 stop bit (with check performed), 2 bits (without check)

#### Error detection domain

- Cyclic redundancy check (CRC)

The following table describes the data format.

11-bit character frame (Bits 1 to 8 are data bits)

Start bit	BIT1	BIT2	BIT3	BIT4	BIT5	BIT6	BIT7	BIT8	Check bit	Stop bit
-----------	------	------	------	------	------	------	------	------	-----------	----------

10-bit character frame (Bits 1 to 7 are data bits)

Start bit	BIT1	BIT2	BIT3	BIT4	BIT5	BIT6	BIT7	Check bit	Stop bit
-----------	------	------	------	------	------	------	------	-----------	----------

In a character frame, only the data bits carry information. The start bit, check bit, and stop bit are used to facilitate the transmission of the data bits to the destination device. In practical applications, you must set the data bits, parity check bits, and stop bits consistently.

In RTU mode, a new frame always must be preceded by a time gap with a minimum length of 3.5 bytes. On a network where the transmission rate is calculated based on the baud rate, the transmission time of 3.5 bytes can be easily obtained. After the idle time ends, the data domains are sent in the following sequence: slave address, operation command code, data, and CRC check character. Each byte sent in each domain includes 2 hexadecimal characters (0–9, A–F). The network devices always monitor the communication bus. After receiving the first domain (address information), each network device identifies the byte. After the last byte is sent, a similar transmission interval (with a minimum length of 3.5 bytes) is used to indicate that the frame transmission ends. Then, the transmission of a new frame starts.

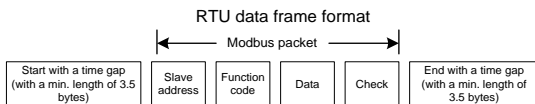

The information of a frame must be sent in a continuous data flow. If there is an interval greater than the transmission time of 1.5 bytes before the transmission of the entire frame is complete, the receiving device deletes the incomplete information, and mistakes the subsequent byte for the address domain of a new frame. Similarly, if the transmission interval between two frames is shorter than the transmission time of 3.5 bytes, the receiving device mistakes it for the data of the last frame. The CRC check value is incorrect due to the disorder of the frames, and thus a communication fault occurs.

The following table describes the standard structure of an RTU frame.

START (frame header)	T1-T2-T3-T4 (time gap with a min. length of 3.5 bytes)
ADDR (slave address domain)	Communication address: 0–247 (decimal system) (0 is the broadcast address)
CMD (function domain)	03H: read slave parameters 06H: write slave parameters
DATA (N-1) ... DATA (0) (data domain)	Data of 2×N bytes, main content of the communication as well as the core of data exchanging
CRC CHK LSBs	Detection value: CRC (16 bits)

CRC CHK MSBs	
END (frame tail)	T1-T2-T3-T4 (time gap with a min. length of 3.5 bytes)

### 7.2.2.2 RTU communication frame error check modes

During data transmission, errors may occur due to various reasons. For example, if a sending message contains a logic "1", A-B potential difference on RS485 should be 6V, but the difference changes to -6V in reality because of electromagnetic interference, and then the other devices take the logic in the message as "0". Without check, the data receiving device cannot identify data errors and may make an incorrect response. The incorrect response may cause severe problems. Therefore, the data must be checked.

The check is implemented as follows: The sender calculates the to-be-sent data based on a specific algorithm to obtain a result, appends the result at the end of the message, and sends them together. After receiving the message, the receiver calculates the data based on the same algorithm to obtain a result, and compares the result with that sent by the sender. If the results are the same, the message is correct. Otherwise, the message is considered wrong.

The error check of a frame includes two parts, namely bit check on individual bytes (that is, odd/even check bit using the check bit in the character frame), and whole data check (CRC check).

#### Bit check on individual bytes (odd/even check)

You can select the bit check mode as required, or you can choose not to perform the check, which will affect the check bit setting of each byte. Goodrive18 series two-in-one VFD uses the even parity check by default.

Definition of even check: Before the data is sent, an even check bit is added to indicate whether the number of "1" in the to-be-sent data is odd or even. If it is even, the check bit is set to "0"; and if it is odd, the check bit is set to "1".

Definition of odd check: Before the data is sent, an odd check bit is added to indicate whether the number of "1" in the to-be-sent data is odd or even. If it is odd, the check bit is set to "0"; and if it is even, the check bit is set to "1".

For example, the data bits to be sent are "11001110", including five "1". If the even check is applied, the even check bit is set to "1"; and if the odd check is applied, the odd check bit is set to "0". During the transmission of the data, the odd/even check bit is calculated and placed in the check bit of the frame. The receiving device performs the odd/even check after receiving the data. If it finds that the odd/even parity of the data is inconsistent with the preset information, it determines that a communication error occurs.

#### CRC check mode



A frame in the RTU format includes an error detection domain based on the CRC calculation. The CRC domain checks all the content of the frame. The CRC domain consists of two bytes, including 16 binary bits. It is calculated by the sender and added to the frame. The receiver calculates the CRC of the received frame, and compares the result with the value in the received CRC domain. If the two CRC values are not equal to each other, errors occur in the transmission.

During CRC, 0xFFFF is stored first, and then a process is invoked to process a minimum of 6 contiguous bytes in the frame based on the content in the current register. CRC is valid only for the 8-bit data in each character. It is invalid for the start, stop, and check bits.

During the generation of the CRC values, the "exclusive or" (XOR) operation is performed on the each 8-bit character and the content in the register. The result is placed in the bits from the least significant bit (LSB) to the most significant bit (MSB), and 0 is placed in the MSB. Then, LSB is detected. If LSB is 1, the XOR operation is performed on the current value in the register and the preset value. If LSB is 0, no operation is performed. This process is repeated 8 times. After the last bit (8th bit) is detected and processed, the XOR operation is performed on the next 8-bit byte and the current content in the register. The final values in the register are the CRC values obtained after operations are performed on all the bytes in the frame.

The calculation adopts the international standard CRC check rule. You can refer to the related standard CRC algorithm to compile the CRC calculation program as required.

The following is a simple CRC calculation function for your reference (using the C programming language):

```
unsigned int crc_cal_value(unsigned char*data_value,unsigned char data_length)
{
int i;
unsigned int crc_value=0xffff;
while(data_length-->0)
{
crc_value^=*data_value++;
for(i=0;i<8;i++)
{
if(crc_value&0x0001)
crc_value=(crc_value>>1)^0xa001;
else
```

```

crc_value=crc_value>>1;
    }
}
return(crc_value);
}

```

In the ladder logic, CKSM uses the table look-up method to calculate the CRC value according to the content in the frame. The program of this method is simple, and the calculation is fast, but the ROM space occupied is large. Use this program with caution in scenarios where there are space occupation requirements on programs.

### 7.2.3 ASCII mode

Name	Definition									
Coding system	A communication protocol uses the hexadecimal system. The mapping between a hexadecimal number and ASCII number is as follows:									
	Character	'0'	'1'	'2'	'3'	'4'	'5'	'6'	'7'	
	ASCII CODE	0x30	0x31	0x32	0x33	0x34	0x35	0x36	0x37	
	Character	'8'	'9'	'A'	'B'	'C'	'D'	'E'	'F'	
	ASCII CODE	0x38	0x39	0x41	0x42	0x43	0x44	0x45	0x46	
Data format	Start bit, 7 or 8 data bits, check bit, and stop bit. The data formats are as follows:									
	11-bit character frame:									
	Start bit	BIT1	BIT2	BIT3	BIT4	BIT5	BIT6	BIT7	BIT8	Check bit
10-bit character frame:										
Start bit	BIT1	BIT2	BIT3	BIT4	BIT5	BIT6	BIT7	Check bit	Stop bit	

In ASCII mode, the frame header is ":" ("0\*3A"), frame end is "CRLF" ("0\*0D" "0\*0A") by default. In ASCII mode, all the data bytes, except for the frame header and frame end, are transmitted in ASCII code mode, in which four MSB groups will be sent out first and then, four LSB groups will be sent out. In ASCII mode, the data length is 8 bit. As for "A"-"F", its capital letters is adopted for ASCII code. The data now adopts LRC checkout which covers slave address to data information. The checksum equals the complement of the character sum of all the participated checkout data.

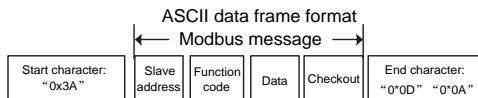

### Standard structure of an ASCII frame:

START	':' (0x3A)
Address Hi	Communication address: An 8-bit address is formed by the combination of two ASCII codes.
Address Lo	
Function Hi	Function code: An 8-bit address is formed by the combination of two ASCII codes.
Function Lo	
DATA(N-1) ... DATA(0)	Data content: nx8-bit data content is formed by combination of 2n ASCII codes. n<=16, a maximum of 32 ASCII codes
LRC CHK Hi	LRC check code: An 8-bit check code is formed by the combination of two ASCII codes.
LRC CHK Lo	
END Hi	End character: END Hi=CR (0x0D), END Lo=LF (0x0A)
END Lo	

### ASCII mode check (LRC Check)

Check code (LRC Check) is the value combined of address and data content result.

The following is a simple LRC calculation function for your reference (using the C programming language):

Static unsigned char

LRC(auchMsg,usDataLen)

unsigned char \*auchMsg;

unsigned short usDataLen;

{

unsigned char uchLRC=0;

while(usDataLen--)

uchLRC+=\*auchMsg++;

```
return((unsigned char)-((char)uchLRC));
```

```
}
```

## 7.3 Command codes and communication data

### 7.3.1 RTU mode

#### 7.3.1.1 Command code 03H (0000 0011), reading N words (continuously reading a maximum of 16 words)

The command code 03H is used by the master to read data from the VFD. The count of data to be read depends on the "data count" in the command. A maximum of 16 pieces of data can be read. The addresses of the read parameters must be contiguous. Each piece of data occupies 2 bytes, that is, one word. The command format is presented using the hexadecimal system (a number followed by "H" indicates a hexadecimal value). One hexadecimal value occupies one byte.

The 03H command is used to read information including the parameters and running status of the VFD.

For example, to read two contiguous data content pieces from 0004H from the VFD with the address of 01H (that is, to read content from data addresses 0004H and 0005H), the frame structure is as follows:

RTU master command (from the master to the VFD)		RTU slave response (from the VFD to the master)	
START	T1-T2-T3-T4	START	T1-T2-T3-T4
ADDR	01H	ADDR	01H
CMD	03H	CMD	03H
		Number of bytes	04H
Start address MSB	00H	MSB of data in 0004H	13H
Start address LSB	04H	LSB of data in 0004H	88H
Data count MSB	00H	MSB of data in 0005H	00H
Data count LSB	02H	LSB of data in 0005H	00H
CRC LSB	85H	CRC CHK LSB	7EH
CRC MSB	CAH	CRC CHK MSB	9DH
END	T1-T2-T3-T4	END	T1-T2-T3-T4

T1-T2-T3-T4 between START and END is to provide at least the time of 3.5 bytes as the leisure time and distinguish two messages for the avoidance of taking two messages as one message.

ADDR=01H means the command message is sent to the VFD with the address of 01H and ADDR occupies one byte.

CMD=03H means the command message is sent to read data from the VFD and CMD occupies one byte.

"Start address" means reading data from the address and it occupies two bytes with the MSB on the left and LSB on the right.

"Data count" indicates the count of data to be read (unit: word).

"Start address" is "0004H" and "Data count" is 0002H, indicating that data is to be read from the data addresses of 0004H and 0005H.

CRC check occupies two bytes with the MSB on the left and LSB on the right.

The response information is described as follows:

"ADDR" is "01H", indicating that the message is sent by the VFD whose address is 01H. The ADDR information occupies one byte.

"CMD" is "03H", indicating that the message is a response of the VFD to the 03H command of the master for reading data. The CMD information occupies one byte.

"Number of bytes" indicates the number of bytes between a byte (not included) and the CRC byte (not included). The value "04" indicates that there are four bytes of data between "Number of bytes" and "CRC CHK LSB", that is, "MSB of data in 0004H", "LSB of data in 0004H", "MSB of data in 0005H", and "LSB of data in 0005H".

A piece of data contains two bytes, with the MSB on the left and LSB on the right. From the response, the data in 0004H is 1388H, and that in 0005H is 0000H.

CRC check occupies two bytes, with the LSB on the left and MSB on the right.

### 7.3.1.2 Command word 06H (0000 0110), writing a word

This command is used by the master to write data to the VFD. One command can be used to write only one piece of data. It is used to modify the parameters and running mode of the VFD.

For example, to write 5000 (1388H) to 0004H of the VFD whose address is 02H, the frame structure is as follows.

RTU master command (from the master to the VFD)		RTU slave response (from the VFD to the master)	
START	T1-T2-T3-T4	START	T1-T2-T3-T4
ADDR	02H	ADDR	02H
CMD	06H	CMD	06H
MSB of data writing address	00H	MSB of data writing address	00H
LSB of data writing	04H	LSB of data writing	04H

RTU master command (from the master to the VFD)		RTU slave response (from the VFD to the master)	
address		address	
MSB of to-be-written data	13H	MSB of to-be-written data	13H
LSB of to-be-written data	88H	LSB of to-be-written data	88H
CRC CHK LSB	C5H	CRC CHK LSB	C5H
CRC CHK MSB	6EH	CRC CHK MSB	6EH
END	T1-T2-T3-T4	END	T1-T2-T3-T4

**Note:** Sections 7.3.1.1 and 7.3.1.2 mainly describe the command formats.

### 7.3.1.3 Command code 08H (0000 1000), diagnosis

Sub-function code description:

Sub-function code	Description
0000	Return data based on query requests

For example, to query about the circuit detection information about the VFD whose address is 01H, the query and return strings are the same, and the format is described as follows.

RTU master command		RTU slave response	
START	T1-T2-T3-T4	START	T1-T2-T3-T4
ADDR	01H	ADDR	01H
CMD	08H	CMD	08H
Sub-function code MSB	00H	Sub-function code MSB	00H
Sub-function code LSB	00H	Sub-function code LSB	00H
MSB of to-be-written data	12H	MSB of to-be-written data	12H
LSB of to-be-written data	ABH	LSB of to-be-written data	ABH
CRC CHK LSB	ADH	CRC CHK LSB	ADH
CRC CHK MSB	14H	CRC CHK MSB	14H
END	T1-T2-T3-T4	END	T1-T2-T3-T4

### 7.3.1.4 Command code 10H, continuous writing

Command code 10H means that the master writes data to the VFD while the number of data pieces depends on the "data count" in the command code. A maximum of 16 pieces of data

can be continuously written.

For example, to write 5000 (1388H) to 0004H and 50 (0032H) to 0005H of the VFD whose slave address is 02H, the frame structure is as follows:

RTU master command (from the master to the VFD):

START	T1-T2-T3-T4 (time gap with a min. length of 3.5 bytes)
ADDR	02H
CMD	10H
MSB of data writing address	00H
LSB of data writing address	04H
Data count MSB	00H
Data count LSB	02H
Number of bytes	04H
MSB of data in 0004H	13H
LSB of data in 0004H	88H
MSB of data in 0005H	00H
LSB of data in 0005H	32H
CRC LSB	C5H
CRC MSB	6EH
END	T1-T2-T3-T4 (time gap with a min. length of 3.5 bytes)

RTU slave response (from the VFD to the master)

START	T1-T2-T3-T4 (time gap with a min. length of 3.5 bytes)
ADDR	02H
CMD	10H
MSB of data writing address	00H
LSB of data writing address	04H
Data count MSB	00H
Data count LSB	02H
CRC LSB	C5H
CRC MSB	6EH
END	T1-T2-T3-T4 (time gap with a min. length of 3.5 bytes)

### 7.3.2 ASCII mode

#### 7.3.2.1 Command code 03H (0000 0011), reading N words (continuously reading a maximum of 16 words)

For example, for the VFD whose slave address is 01H, the start address of internal storage is 0004, to read two words continuously, the structure of this frame is as follows:

ASCII master command (from the master to the VFD)		ASCII slave response (from the VFD to the master)	
START	':'	START	':'
ADDR	'0'	ADDR	'0'
	'1'		'1'
CMD	'0'	CMD	'0'
	'3'		'3'
Start address MSB	'0'	Number of bytes	'0'
	'0'		'4'
Start address LSB	'0'	MSB of data in 0004H	'1'
	'4'		'3'
Data count MSB	'0'	LSB of data in 0004H	'8'
	'0'		'8'
Data count LSB	'0'	MSB of data in 0005H	'0'
	'2'		'0'
LRC CHK Hi	'F'	LSB of data in 0005H	'0'
LRC CHK Lo	'6'		'0'
END Hi	CR	LRC CHK Hi	'5'
END Lo	LF	LRC CHK Lo	'D'
		END Hi	CR
		END Lo	LF

#### 7.3.2.2 Command word 06H (0000 0110), writing a word

For example, to write 5000 (1388H) to 0004H of the VFD whose address is 02H, the frame structure is as follows.

ASCII master command (from the master to the VFD)		ASCII slave response (from the VFD to the master)	
START	':'	START	':'
ADDR	'0'	ADDR	'0'
	'2'		'2'
CMD	'0'	CMD	'0'
	'6'		'6'



ASCII master command (from the master to the VFD)		ASCII slave response (from the VFD to the master)	
MSB of data writing address	'0'	MSB of data writing address	'0'
	'0'		'0'
LSB of data writing address	'0'	LSB of data writing address	'0'
	'4'		'4'
MSB of to-be-written data	'1'	MSB of to-be-written data	'1'
	'3'		'3'
LSB of to-be-written data	'8'	LSB of to-be-written data	'8'
	'8'		'8'
LRC CHK Hi	'5'	LRC CHK Hi	'5'
LRC CHK Lo	'9'	LRC CHK Lo	'9'
END Hi	CR	END Hi	CR
END Lo	LF	END Lo	LF

### 7.3.2.3 Command code 08H (0000 1000), diagnosis

Sub-function code description:

Sub-function code	Description
0000	Return data based on query requests

For example, to query about the circuit detection information about the VFD whose address is 01H, the query and return strings are the same, and the format is described as follows.

ASCII master command (from the master to the VFD)		ASCII slave response (from the VFD to the master)	
START	':'	START	':'
ADDR	'0'	ADDR	'0'
	'1'		'1'
CMD	'0'	CMD	'0'
	'8'		'8'
MSB of data writing address	'0'	MSB of data writing address	'0'
	'0'		'0'
LSB of data writing address	'0'	LSB of data writing address	'0'
	'0'		'0'
MSB of to-be-written data	'1'	MSB of to-be-written data	'1'
	'2'		'2'
LSB of to-be-written data	'A'	LSB of to-be-written data	'A'
	'B'		'B'
LRC CHK Hi	'3'	LRC CHK Hi	'3'

ASCII master command (from the master to the VFD)		ASCII slave response (from the VFD to the master)	
LRC CHK Lo	'A'	LRC CHK Lo	'A'
END Hi	CR	END Hi	CR
END Lo	LF	END Lo	LF

### 7.3.2.4 Command code 10H, continuous writing

Command code 10H means that the master writes data to the VFD while the number of data pieces depends on the "data count" in the command code. A maximum of 16 pieces of data can be continuously written.

For example, to write 5000 (1388H) to 0004H and 50 (0032H) to 0005H of the VFD whose slave address is 02H, the frame structure is as follows:

ASCII master command (from the master to the VFD)		ASCII slave response (from the VFD to the master)	
START	':'	START	':'
ADDR	'0'	ADDR	'0'
	'2'		'2'
CMD	'1'	CMD	'1'
	'0'		'0'
MSB of data writing address	'0'	MSB of data writing address	'0'
	'0'		'0'
LSB of data writing address	'0'	LSB of data writing address	'0'
	'4'		'4'
Data count MSB	'0'	Data count MSB	'0'
	'0'		'0'
Data count LSB	'0'	Data count LSB	'0'
	'2'		'2'
Number of bytes	'0'	LRC CHK Hi	'E'
MSB of data in 0004H	'4'	LRC CHK Lo	'8'
LSB of data in 0004H	'1'	END Hi	CR
MSB of data in 0005H	'3'	END Lo	LF
LSB of data in 0005H	'8'	/	/
Number of bytes	'8'	/	/
MSB of data in 0004H	'0'	/	/
LSB of data in 0004H	'0'	/	/
MSB of data in 0005H	'3'	/	/
	'2'	/	/

ASCII master command (from the master to the VFD)		ASCII slave response (from the VFD to the master)	
LRC CHK Hi	'1'	/	/
LRC CHK Lo	'7'	/	/
END Hi	CR	/	/
END Lo	LF	/	/

## 7.4 Data address definition

This section describes the address definition of communication data. The addresses are used for controlling the running, obtaining the status information, and setting function parameters of the VFD.

### 7.4.1 Function code address format rules

The address of a function code consists of two bytes, with the MSB on the left and LSB on the right. The MSB ranges from 00 to ffH, and the LSB also ranges from 00 to ffH. The MSB is the hexadecimal form of the group number before the dot mark, and LSB is that of the number behind the dot mark. Take [P05.05](#) as an example: The group number is 05, that is, the MSB of the parameter address is the hexadecimal form of 05; and the number behind the dot mark is 05, that is, the LSB is the hexadecimal form of 05. Therefore, the function code address is 0505H in the hexadecimal form. For [P10.01](#), the parameter address is 0A01H.

Function code	Name	Detailed parameter description	Default value	Modify
<a href="#">P10.00</a>	Simple PLC means	0: Stop after running once. 1: Run at the final value after running once. 2: Cycle running.	0	<input type="radio"/>
<a href="#">P10.01</a>	Simple PLC memory selection	0: Power loss without memory 1: Power loss with memory	0	<input type="radio"/>

#### Note:

- P29 group is the factory parameters which cannot be read or changed. Some parameters cannot be changed when the VFD is in the running state and some parameters cannot be changed in any state. The setting range, unit and related descriptions should be paid attention to when modifying the function codes.

- Besides, EEPROM is stocked frequently, which may shorten the usage time of EEPROM. For users, some functions are not necessary to be stocked on the communication mode. The needs can be met on by changing the value in RAM. Changing the MSB of the function code from 0 to 1 can also realize the function. For example, the function code [P00.07](#) is not stocked into EEPROM. Only by changing the value in RAM can set the address to 8007H. This address can only be used in writing RAM other than reading. If it is used to read, it is an invalid address.

#### 7.4.2 Address description of other function codes

In addition to modifying the parameters of the VFD, the master can also control the VFD, such as starting and stopping the VFD, and monitoring the running status of the VFD. The following table lists other function parameters.

Function	Address	Description	R/W
Communication-based control command	2000H	0001H: forward running	R/W
		0002H: reverse running	
		0003H: forward jogging	
		0004H: reverse jogging	
		0005H: stop	
		0006H: coast to stop (emergency stop)	
		0007H: fault reset	
		0008H: jogging stop	
Communication-based setting address	2001H	Communication-set frequency (0–Fmax, unit: 0.01Hz)	R/W
	2002H	PID reference, range (0–1000, 1000 corresponds to 100.0%)	
	2003H	PID feedback, range (0–1000, 1000 corresponds to 100.0%)	R/W
	2004H	Torque setting (-3000–3000, 1000 corresponds to the 100.0% of the rated current of the motor)	R/W
	2005H	The upper limit frequency setting during	R/W

Function	Address	Description	R/W
		forward rotation (0–Fmax (unit: 0.01Hz))	
	2006H	The upper limit frequency setting during reverse rotation (0–Fmax (unit: 0.01Hz))	R/W
	2007H	The upper limit torque of electromotion torque (0–3000, 1000 corresponds to the 100.0% of the rated current of the motor)	R/W
	2008H	The upper limit torque of braking torque (0–3000, 1000 corresponds to the 100.0% of the rated current of the motor)	R/W
	2009H	Special control command word Bit0–1: =00: motor 1    =01: motor 2 =10: motor 3    =11: motor 4 Bit2: =1 torque control prohibit =0: torque control prohibit invalid Bit3: =1 power consumption clear =0: no power consumption clear Bit4: =1 pre-exciting    =0: pre-exciting prohibition Bit5: =1 DC braking    =0: DC braking prohibition	R/W
	200AH	Virtual input terminal command, range: 0x000–0x1FF	R/W
	200BH	Virtual output terminal command, range: 0x00–0x0F	R/W
	200CH	Voltage setting value (special for V/F separation) (0–1000, 1000 corresponds to the 100.0% of the rated voltage of the motor)	R/W

Function	Address	Description	R/W	
	200DH	AO output setting 1 (-1000–1000, 1000 corresponds to 100.0%)	R/W	
	200EH	AO output setting 2 (-1000–1000, 1000 corresponds to 100.0%)	R/W	
SW 1 of the VFD	2100H	0001H: forward running	R	
		0002H: reverse running		
		0003H: stop		
		0004H: fault		
		0005H: POF state		
		0006H: pre-exciting state		
SW 1 of the VFD	2101H	Bit0: =0: not ready to run =1: ready to run Bit1–2: =00: motor 1 =01: motor 2 =10: Reserved =11: Reserved Bit3: =0: AM =1: SM Bit4: =0: pre-alarm without overload =1: overload pre-alarm Bit5– Bit6: =00: keypad control =01: terminal control =10: communication control	R	
Fault code of the VFD	2102H	See the fault type description.	R	
Identifying code of the VFD	2103H	GD18-----0x0106	R	
Operation frequency	3000H	0–Fmax, unit: 0.01Hz	Compatible with	R

Function	Address	Description	R/W
Set frequency	3001H	0–Fmax, unit: 0.01Hz	the communication addresses of GD, CHF100A, and CHV100 series
Bus voltage	3002H	0.0–2000.0V, unit: 0.1V	
Output voltage	3003H	0–1200V, unit: 1V	
Output current	3004H	0.0–3000.0A, unit: 0.1A	
Running speed	3005H	0–65535, unit: 1RPM	
Output power	3006H	-300.0–300.0%, unit: 0.1%)	
Output torque	3007H	-250.0–250.0%, unit: 0.1%	
PID setting	3008H	-100.0–100.0%, unit: 0.1%	
PID feedback	3009H	-100.0–100.0%, unit: 0.1%	
Input status	300AH	000–1FF	
Output status	300BH	000–1FF	
AI 1	300CH	0.00–10.00V, unit: 0.01V	
AI 2	300DH	0.00 – 10.00V, unit: 0.01V	
AI 3	300EH	-10.00 – 10.00V, unit: 0.01V	
AI 4	300FH	Reserved	
Reading high speed pulse 1 input	3010H	0.00 – 50.00kHz, unit: 0.01Hz	
Reading high speed pulse 2 input	3011H	Reserved	
PLC and current step of multi-step speed	3012H	0 – 15	
External length	3013H	0 – 65535	
External counting value	3014H	0 – 65535	
Torque setting	3015H	-300.0 – 300.0%, unit: 0.1%)	
VFD code	3016H		
Fault code	5000H		

The Read/Write (R/W) characteristics indicate whether a function code can be read and written. For example, "Communication-based control command" can be written, and therefore the command code 06H is used to control the VFD. "R" indicates that a function code is read

only, and "W" indicates that a function code is written only.

**Note:** Some parameters in the preceding table are valid only after they are enabled. Take the running and stop operations as examples, you need to set "Channel of running commands" ([P00.01](#)) to "Communication", and set "PID given source" ([P09.00](#)) to "Modbus".

The following table describes the encoding rules of device codes (corresponding to the identification code 2103H of the VFD).

Eight MSBs	Meaning	Eight LSBs	Meaning
01	Goodrive	06	Goodrive18 series two-in-one VFD

**Note:** A device code consists of 16 bits, with 8 MSBs and 8 LSBs. The 8 MSBs indicate the model series, and the 8 LSBs indicate the derivative model.

### 7.4.3 Fieldbus scale

In actual applications, communication data is represented in the hexadecimal form, but hexadecimal values cannot represent decimals. For example, 50.12 Hz cannot be represented in the hexadecimal form. In such cases, multiply 50.12 by 100 to obtain an integer 5012, and then 50.12 can be represented as 1394H (5012 in the decimal form) in the hexadecimal form.

In the process of multiplying a non-integer by a multiple to obtain an integer, the multiple is referred to as a fieldbus scale.

The fieldbus scale depends on the number of decimals in the value specified in "Setting range" or "Default value". If there are n decimals in the value, the fieldbus scale m is the nth-power of 10. Take the following as an example, where m is 10.

Function code	Name	Description	Default value	Modify
<a href="#">P01.20</a>	Delay for recovery from hibernation	0.0–3600.0s (valid when P01.19 is 2)	0.0s	<input type="radio"/>
<a href="#">P01.21</a>	Restart after power off	0: Disallow 1: Allow	0	<input type="radio"/>

If "Setting range" or "Default value" contains one decimal, the fieldbus scale is 10. If the value received by the upper computer is 50, "Delay of auto fault reset" of the rectifier is 5.0



(5.0=50/10).

To set "Delay for recovery from hibernation" to 5.0s through Modbus communication, you need first to multiply 5.0 by 10 according to the scale to obtain an integer 50, that is, 32H in the hexadecimal form, and then send the following write command:

<b>01</b>	<b>06</b>	<b>01 14</b>	<b>00 32</b>	<b>49 E7</b>
VFD address	Read command	Parameters address	Data number	CRC check

After receiving the command, the VFD converts 50 into 5.0 based on the fieldbus scale, and then sets "Delay for recovery from hibernation" to 5.0s.

For another example, after the upper computer sends the " Delay for recovery from hibernation" parameter read command, the master receives the following response from the VFD:

<b>01</b>	<b>03</b>	<b>02</b>	<b>00 32</b>	<b>39 91</b>
VFD address	Read command	2-byte data	Parameters data	CRC check

The parameter data is 0032H, that is, 50, so 5.0 is obtained based on the fieldbus scale (50/10=5.0). In this case, the master identifies that the "Delay for recovery from hibernation" is 5.0s.

#### 7.4.4 Error messages

Operation errors may occur during communication-based control. For example, some parameters are read only, but a write command is sent. In this case, the VFD returns an error message. Error messages are sent from the VFD to the master. The following table lists the error messages.

Error code	Name	Description
01H	Invalid command	The command code received by the upper computer is not allowed to be executed. The possible causes are as follows: <ul style="list-style-type: none"> <li>• The function code is applicable only on new devices and is not implemented on this device.</li> <li>• The slave is in faulty state when processing this request.</li> </ul>
02H	Invalid data address	For the VFD, the data address in the request of the upper computer is not allowed. In particular, the combination of the register address and to-be-sent bytes is invalid.
03H	Invalid data	The received data domain contains a value that is

Error code	Name	Description
	value	not allowed. The value indicates the error of the remaining structure in the combined request. <b>Note:</b> It does not mean that the data item submitted for storage in the register includes a value unexpected by the program.
04H	Operation failure	The parameter is set to an invalid value in the write operation. For example, a function input terminal cannot be set repeatedly.
05H	Password error	The password entered in the password verification address is different from that set in <a href="#">P07.00</a> .
06H	Data frame error	The length of the data frame sent by the upper computer is incorrect, or in the RTU format, the value of the CRC check bit is inconsistent with the CRC value calculated by the lower computer
07H	Parameter read-only	The parameter to be modified in the write operation of the upper computer is a read-only parameter.
08H	Parameter cannot be modified in running	The parameter to be modified in the write operation of the upper computer cannot be modified during the running of the VFD.
09H	Password protection	A user password is set, and the upper computer does not provide the password to unlock the system when performing a read or write operation. The error of "system locked" is reported.

When returning a response, the slave uses a function code domain and fault address to indicate whether it is a normal response (no error) or exception response (some errors occur). In a normal response, the slave returns the corresponding function code and data address or sub-function code. In an exception response, the slave returns a code that is equal to a normal code, but the MSB is logic 1.

For example, if the master sends a request message to the slave for reading a group of function code address data, the code is generated as follows:

0 0 0 0 0 1 1 (03H in the hexadecimal form)

In a normal response, the slave returns the same function code. In an exception response, the slave returns:

1 0 0 0 0 1 1 (83H in the hexadecimal form)

In addition to the modification of the code, the slave returns a byte of exception code that

describes the cause of the exception. After receiving the exception response, the typical processing of the master is to send the request message again or modify the command based on the fault information.

For example, to set the "Channel of running commands" ([P00.01](#), the parameter address is 0000H) to 03 for the VFD whose address is 01H, the command is as follows:

<b><u>01</u></b>	<b><u>06</u></b>	<b><u>00 01</u></b>	<b><u>00 03</u></b>	<b><u>98 0B</u></b>
VFD address	Read command	Parameters address	Parameters data	CRC check

The setting range of the "Channel of running commands" is 0 to 2. The value 3 exceeds the setting range. In this case, the VFD returns an error message as shown in the following:

<b><u>01</u></b>	<b><u>86</u></b>	<b><u>04</u></b>	<b><u>43 A3</u></b>
VFD address	Abnormal response code	Fault code	CRC check

The exception response code 86H (generated based on the MSB "1" of the write command 06H) indicates that it is an exception response to the write command (06H). The error code is 04H that indicates the error "Operation failure", which means "The parameter is set to an invalid value in the write operation".

## 7.5 Reading and writing examples

For the formats of the read and write commands, see section 7.3.

### 7.5.1 Example of reading command 03H

Example 1: Read status word 1 of the VFD whose address is 01H. According to the table of address description of other function codes, the parameter address of status word 1 of the VFD is 2100H.

#### RTU mode

The read command sent to the VFD is as follows:

<b><u>01</u></b>	<b><u>03</u></b>	<b><u>21 00</u></b>	<b><u>00 01</u></b>	<b><u>8E 36</u></b>
VFD address	Read command	Parameters address	Data number	CRC check

Assume that the following response is returned:

<b><u>01</u></b>	<b><u>03</u></b>	<b><u>02</u></b>	<b><u>00 03</u></b>	<b><u>F8 45</u></b>
VFD address	Read command	Data address	Data content	CRC check

**ASCII mode**

The command sent to the VFD is as follows:

:	<u>01</u>	<u>03</u>	<u>21 00</u>	<u>00 01 DA</u>	<u>CR LF</u>	
START	VFD address	Read command	Parameters address	Data number	LRC check	END

If the operation is successful, the following response is returned:

:	<u>01</u>	<u>03</u>	<u>02 00 03</u>	<u>F7</u>	<u>CR LF</u>	
START	VFD address	Read command	Byte number	Data content	LRC check	END

The data content that the VFD returns is 0003H, which indicates the VFD has stopped.

**7.5.2 Example of writing command 06H**

Example 1: Make the VFD with the address of 03H to run forward. According to the table of address description of other function codes, the parameter address of "communication-based control command" is 2000H and forward running is 0001. See the following table.

Function	Address	Description	R/W
Communication based control command	2000H	0001H: forward running	R/W
		0002H: reverse running	
		0003H: forward jogging	
		0004H: reverse jogging	
		0005H: stop	
		0006H: coast to stop (emergency stop)	
		0007H: fault reset	
		0008H: jogging stop	

**RTU mode**

The command sent from the master is as follows:

<b><u>03</u></b>	<b><u>06</u></b>	<b><u>20 00</u></b>	<b><u>00 01</u></b>	<b><u>42 28</u></b>
VFD address	Write command	Parameters address	Forward running	CRC check

If the operation is successful, the following response is returned (same as the command sent from the master):

<b><u>03</u></b>	<b><u>06</u></b>	<b><u>20 00</u></b>	<b><u>00 01</u></b>	<b><u>42 28</u></b>
VFD address	Write command	Parameters address	Forward running	CRC check

### ASCII mode

The command sent from the master is as follows:

:	<b><u>01</u></b>	<b><u>06</u></b>	<b><u>20 00</u></b>	<b><u>00 01</u></b>	<b><u>D6</u></b>	<b><u>CR LF</u></b>
START	VFD address	Write command	Parameters address	Data number	LRC check	END

If the operation is successful, the following response is returned (same as the command sent from the master):

:	<b><u>01</u></b>	<b><u>06</u></b>	<b><u>20 00</u></b>	<b><u>00 01</u></b>	<b><u>D6</u></b>	<b><u>CR LF</u></b>
START	VFD address	Write command	Parameters address	Data number	LRC check	END

Example 2: Set the max. output frequency to 100 Hz for the VFD with the address of 03H.

Function code	Name	Description	Default value	Modify
<a href="#">P00.03</a>	Max. output frequency	Used to set the max. output frequency of the VFD. It is the basis of frequency setup and the acceleration/deceleration. Setting range: <a href="#">P00.04</a> –400.00 Hz	50.00Hz	⊙

See the figures behind the radix point, the fieldbus ratio value of max. output frequency ([P00.03](#)) is 100. 100Hz timed by 100 is 10000 and the corresponding hex is 2710H.

### RTU mode

The command sent from the master is as follows:

<b><u>03</u></b>	<b><u>06</u></b>	<b><u>00 03</u></b>	<b><u>27 10</u></b>	<b><u>62 14</u></b>
VFD address	Write command	Parameters address	Forward running	CRC check

If the operation is successful, the following response is returned (same as the command sent from the master):

<b><u>03</u></b>	<b><u>06</u></b>	<b><u>00 03</u></b>	<b><u>27 10</u></b>	<b><u>62 14</u></b>
VFD address	Write command	Parameters address	Forward running	CRC check

### ASCII mode

The command sent from the master is as follows:

	<b><u>03</u></b>	<b><u>06</u></b>	<b><u>00 03</u></b>	<b><u>27 10</u></b>	<b><u>BD CR LF</u></b>
START	VFD address	Write command	Parameters address	Data number	LRC check      END

If the operation is successful, the following response is returned (same as the command sent from the master):

	<b><u>03</u></b>	<b><u>06</u></b>	<b><u>00 03</u></b>	<b><u>27 10</u></b>	<b><u>BD CR LF</u></b>
START	VFD address	Write command	Parameters address	Data number	LRC check      END

### 7.5.3 Example of continuous writing command 10H

Example 1: Make the VFD whose address is 01H run forward at 10Hz. According to the table of address description of other function codes, the parameter address of "communication-based control command" is 2000H and forward running is 0001. The address of "Communication-set frequency" is 2001H and 10Hz corresponds to 03E8H.

Function	Address	Description	R/W
Communication-based control command	2000H	0001H: forward running	R/W
		0002H: reverse running	
		0003H: forward jogging	
		0004H: reverse jogging	
		0005H: stop	
		0006H: coast to stop (emergency stop)	
		0007H: fault reset	
		0008H: jogging stop	
Communication-based setting address	2001H	Communication-set frequency (0–Fmax, unit: 0.01Hz)	R/W
	2002H	PID reference, range (0–1000, 1000 corresponds to 100.0%)	

### RTU mode

The command sent from the master is as follows:

01    10    20 00    00 02    04    00 01    03 E8    3B 10  
 VFD    Continuous    Parameters    Data    Byte    Forward    10Hz    CRC check  
 address    writing    address    number    number    running

If the operation is successful, the following response is returned:

01    10    20 00    00 02    4A 08  
 VFD    Continuous    Parameters    Data    CRC check  
 address    writing    address    number

### ASCII mode

The command sent from the master is as follows:

:    01    10    20 00    00 02    04    00 01    03 E8    BD    CR LF  
 START    VFD    Continuous    Parameters    Data    Byte    Forward    10Hz    LRC    END  
 address    writing    address    number    number    running    check

If the operation is successful, the following response is returned:

:    01    10    20 00    00 02    CD    CR LF  
 START    VFD    Continuous    Parameters    Data    LRC    END  
 address    writing    address    number    check

Example 2: Set the ACC time and DEC time to 10s and 20s for the VFD whose address is 01H.

<a href="#">P00.11</a>	ACC time 1	Setting range of <a href="#">P00.11</a> and <a href="#">P00.12</a> : 0.0–3600.0s	Model depended	<input type="radio"/>
<a href="#">P00.12</a>	DEC time 1		Model depended	<input type="radio"/>

The corresponding address of [P00.11](#) is 000B, the ACC time of 10s corresponds to 0064H, and the DEC time of 20s corresponds to 00C8H.

### RTU mode

The command sent from the master is as follows:

01    10    00 0B    00 02    04    00 64    00 C8    F2 55  
 VFD    Continuous    Parameters    Data    Byte    10s    20s    CRC check  
 address    writing    address    number    number

If the operation is successful, the following response is returned:

<u>01</u>	<u>10</u>	<u>00 0B</u>	<u>00 02</u>	<u>30 0A</u>
VFD address	Continuous writing command	Parameters address	Data number	CRC check

## ASCII mode

The command sent from the master is as follows:

:	<u>01</u>	<u>10</u>	<u>00 0B</u>	<u>00 02</u>	<u>04</u>	<u>00 64</u>	<u>00 C8 B2</u>	<u>CR LF</u>
START	VFD address	Continuous writing command	Parameters address	Data number	10s	20s	LRC check	END

If the operation is successful, the following response is returned:

:	<u>01</u>	<u>10</u>	<u>00 0B</u>	<u>00 02</u>	<u>E2</u>	<u>CR LF</u>
START	VFD address	Continuous writing command	Parameters address	Data number	LRC check	END

**Note:** In the preceding command description, spaces are added to a command just for explanatory purposes. In practical applications, no space is required in the commands.

## 7.6 Common communication faults

Common communication faults include the following:

- No response is returned.
- The VFD returns an exception response.

Possible causes of no response include the following:

- The serial port is set incorrectly. For example, the adapter uses the serial port COM1, but COM2 is selected for the communication.
- The settings of the baud rates, data bits, end bits, and check bits are inconsistent with those set on the VFD.
- The positive pole (+) and negative pole (-) of the RS485 bus are connected reversely.
- The resistor connected to 485 terminals on the terminal block of the VFD is set incorrectly. The RS485 wire cap on the terminal board of the VFD is not connected. This wire cap is at the back of the terminal block.
- #1 inverter unit and #2 inverter unit conflict in RS485 communication address.



## Appendix A Technical data

### A.1 Derated application

#### A.1.1 Capacity

Choose a VFD model based on the rated current and power of the motor. To endure the rated power of the motor, the rated output current of the VFD must be larger or equal to the rated current of the motor. The rated power of the VFD must be higher or equal to that of the motor.

#### Note:

- The maximum allowable shaft power of the motor is limited to 1.5 times the rated power of the motor. If the limit is exceeded, the VFD automatically restricts the torque and current of the motor. This function effectively protect the input shaft against overload.
- The rated capacity is the capacity at the ambient temperature of 40°C.
- You need to check and ensure that the power flowing through the common DC connection in the common DC system does not exceed the rated power of the motor.

#### A.1.2 Derating

If the ambient temperature on the site where the VFD is installed exceeds 40°C, the altitude exceeds 1000 m, or the switching frequency is changed from 4 kHz to 8, 12, or 15 kHz, the VFD must be derated.

##### A.1.2.1 Derating due to temperature

When the temperature ranges from +40°C to +50°C, the rated output current is derated by 1% for each increased 1°C. For the actual derating, see the following figure.

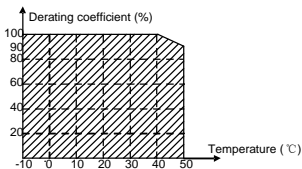

**Note:** It is not recommended to use the VFD at a temperature higher than 50°C. If you do, you shall be held accountable for the consequences caused.

##### A.1.2.2 Derating due to altitude

When the altitude of the site where the VFD is installed is lower than 1000 m, the VFD can run at the rated power. If the altitude on the site is higher than 1000 m but less than 3000 m, derate the VFD by 1% for every increased 100 m. For details about the derating, see the

following figure.

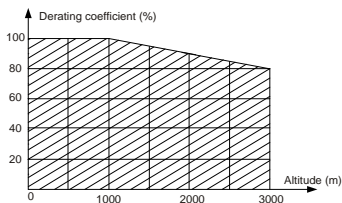

When the altitude exceeds 2000 m, configure an isolation transformer at the VFD input end. When the altitude is higher than 3000 m but lower than 5000 m, consult INVT for technical issues. It is not recommended that the VFD be used at the altitude higher than 5000 m.

#### A.1.2.3 Derating due to carrier frequency

The power of the VFD varies according to carrier frequencies. The rated power of the VFD is defined based on the carrier frequency set in factory. If the carrier frequency exceeds the factory setting, the power of the VFD is derated by 10% for each increased 1 kHz.

## A.2 CE

### A.2.1 CE marking

The CE marking on the VFD nameplate indicates that the VFD is CE-compliant, meeting the regulations of the European low-voltage directive (2006/95/EC) and EMC directive (2004/108/EC).

### A.2.2 EMC compliance declaration

European union (EU) stipulates that the electric and electrical devices sold in Europe cannot generate electromagnetic disturbance that exceeds the limits stipulated in related standards, and can work properly in environments with certain electromagnetic interference. The EMC product standard (EN 61800-3:2004) describes the EMC standards and specific test methods for adjustable speed electrical power drive systems. Products must strictly follow these EMC regulations.

## A.3 EMC regulations

The EMC product standard (EN 61800-3:2004) describes the EMC requirements on VFDs.

### Application environment categories:

Category I: Civilian environments, including application scenarios where VFDs are directly connected to the civil power supply low-voltage grids without intermediate transformers

Category II: All environments except those in Category I.

### VFD categories:

C1: Rated voltage lower than 1000 V, applied to environments of Category I.

C2: Rated voltage lower than 1000 V, non-plug, socket, or mobile devices; power drive systems that must be installed and operated by specialized personnel when applied to environments of Category I

**Note:** The EMC standard IEC/EN 61800-3 no longer restricts the power distribution of VFDs, but it specifies their use, installation, and commissioning. Specialized personnel or organizations must have the necessary skills (including the EMC-related knowledge) for installing and/or performing commissioning on the electrical drive systems.

C3: Rated voltage lower than 1000 V, applied to environments of Category II. They cannot be applied to environments of Category I.

The induction disturbance limit meets the following stipulations:

- Select an optional EMC filter according to Appendix D and install it following the description in the EMC filter manual.
- Select the motor and control cables according to the description in the manual.
- Install the VFD according to the description in the manual.



⚡ VFDs in category C3 cannot be used on civilian low voltage grids.  
Otherwise, radio frequency electromagnetic interference will result.

C4: Rated voltage higher than 1000 V, or rated current higher or equal to 400 A, applied to complex systems in environments of Category II.

## Appendix B Dimensional drawing

This chapter provides the dimensions (unit: mm) for Goodrive18 series two-in-one VFD that is wall mounted.

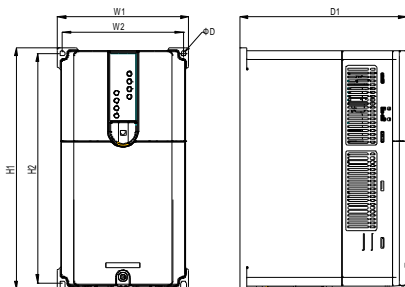

Figure B.1 Wall mounting drawing

VFD model	W1	W2	H1	H2	D1	Hole diameter (d)
GD18-0R7-4-2	107.5	97	195.3	184	164.5	5
GD18-1R5-4-2	107.5	97	195.5	184	164.5	5
GD18-2R2-4-2	138	127	224	211	190	5
GD18-004-4-2	138	127	224	211	190	5
GD18-5R5-4-2	155	143	285	271	196.2	6
GD18-7R5-4-2	155	143	285	271	196.2	6





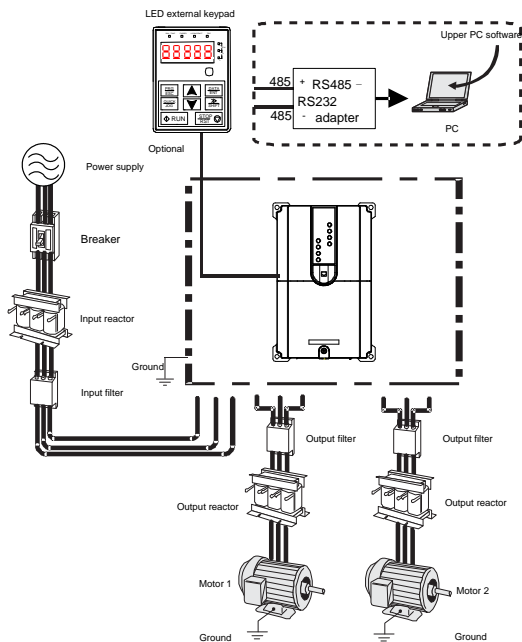

## Appendix C Optional peripheral accessories

This chapter describes how to select optional accessories for Goodrive18 series two-in-one VFD.

### C.1 Wiring of peripheral accessories

The following figure shows the external wiring of Gooddrive18 series two-in-one VFD.



Item	Name	Description
	External keypad	The external keypads include keypads with and without parameter copying.
	Cable	Accessory for signal transmission.
	Breaker	Accessory for electric shock prevention and protection against short-to-ground that may cause current leakage and fire. Select residual-current circuit breakers (RCCBs) that are applicable to VFDs and can restrict high-order harmonics, and of which the rated sensitive current for one VFD is larger than 30 mA.
	Input reactor	Accessory used to improve the current adjustment coefficient on the input side of the VFD, and thus restrict high-order harmonic currents.
	Input filter	Accessory that restricts the electromagnetic interference generated by the VFD and transmitted to the public grid through the power cable. Try to install the input filter near the input terminal side of the VFD.
	Output filter	Accessory used to restrict interference generated in the wiring area on the output side of the VFD. Try to install the output filter near the output terminal side of the VFD.
	Output reactor	Accessory used to lengthen the valid transmission distance of the VFD, which effectively restricts the transient high voltage generated during the switch-on and switch-off of the IGBT module of the VFD.

## C.2 Power supply

	<p>◇ Ensure that the voltage class of the VFD is consistent with that of the grid.</p>
--	--

## C.3 Cables

### C.3.1 Power cables

The sizes of the input power cable and motor cable must meet the local regulation.

**Note:** If the conductivity of the motor cables shield layer cannot meet the requirements, separate PE conductors must be used.

### C.3.2 Control cables

All analog control cables and cables used for frequency input must be shielded cables.

Relay cables need to be those with metal braided shield layers.

Keypads need to be connected by using network cables. In complicated electromagnetic environments, shielded network cables are recommended.

**Note:**

- Analog signals and digital signals cannot use the same cables, and their cables must be arranged separately.
- Check the insulation condition of the VFD input power cable before the connection.

Table C.1 Cable and wiring terminal model selection

VFD model	Recommended cable size (mm <sup>2</sup> )			Recommended terminal model		
	RST	U1V1W1/ U2V2W2	PE	RST	U1V1W1/ U2V2W2	PE
GD18-0R7-4-2	0.75	0.75	0.75	Y 1.25-3	Y 1.25-3	Y 1.25-3
GD18-1R5-4-2	1	0.75	1	Y 1.25-3	Y 1.25-3	Y 1.25-3
GD18-2R2-4-2	1	0.75	1	YL 1.25-4	YL 1.25-4	YL 1.25-4
GD18-004-4-2	4	1	4	Y3.5-4	YL 1.25-4	Y3.5-4
GD18-5R5-4-2	6	1.5	6	YL5.5-5	YL 1.25-4	YL5.5-5
GD18-7R5-4-2	10	2.5	10	YL 8-5	YL 2-4	YL 8-5

Table C.2 Main circuit terminal screw and torque selection

VFD model	Screw specifications			Tightening torque (Nm)		
	RST	U1V1W1/ U2V2W2	PE	RST	U1V1W1/ U2V2W2	PE
GD18-0R7-4-2	M3		M3	1.18		0.6
GD18-1R5-4-2	M3		M3	1.18		0.6
GD18-2R2-4-2	M4		M4	1.18		1.2
GD18-004-4-2	M4		M4	1.18		1.2

VFD model	Screw specifications			Tightening torque (Nm)		
	RST	U1V1W1/ U2V2W2	PE	RST	U1V1W1/ U2V2W2	PE
GD18-5R5-4-2	M5	M4	M5	2.26	1.5	2.5
GD18-7R5-4-2	M5	M4	M5	2.26	1.5	2.5

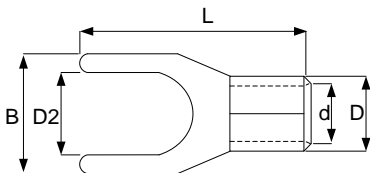

Figure C.1 Y-type terminal diagram

Table C.3 Y-type terminal dimensions

Terminal model	D2	B	L	D $\phi$	d $\phi$	Applicable conductor cross section
	Unit: mm					
Y 1.25-3	3.2	5.7	16.0	3.4	1.7	0.5-1.5
YL 1.25-4	4.3	8.1	16.0	3.4	1.7	0.5-1.5
YL 2-4	4.3	8.1	16.0	4.1	2.3	1.5-2.5
Y3.5-4	4.3	8.0	18.3	5.0	3.0	2.5-4
YL5.5-5	5.3	9.0	18.2	5.6	3.4	4-6
YL 8-5	5.3	9.0	20.8	7.2	4.5	6-10

**Note:**

- Cables of the sizes recommended for the main circuit can be used in scenarios where the ambient temperature is lower than 40°C, the wiring distance is shorter than 100 m, and the current is the rated current.
- You are recommended to use the Y-type terminal, of which the "B" size must be shorter than the main circuit terminal width of the VFD.
- If the control cable and power cable must cross each other, ensure that the angle between them is 90 degrees.
- The insulation resistance is reduced if it is damp inside the motor. If it may be damp, you need to dry the motor and then measure the insulation resistance again.



## C.4 Breaker and electromagnetic contactor

You need to add a fuse to prevent overload.

You need to configure a manually manipulated molded case circuit breaker (MCCB) between the AC power supply and VFD. The breaker must be locked in the open state to facilitate installation and inspection. The capacity of the breaker needs to be 1.5 to 2 times the rated current of the VFD.

	<p>⚡ According to the working principle and structure of breakers, if the manufacturer's regulation is not followed, hot ionized gases may escape from the breaker enclosure when a short-circuit occurs. To ensure safe use, exercise extra caution when installing and placing the breaker. Follow the manufacturer's instructions.</p>
--	---

To ensure safety, you can configure an electromagnetetic contactor on the input side to control the switch-on and switch-off of the main circuit power, so that the input power supply of the VFD can be effectively cut off when a system fault occurs.

VFD model	Breaker (A)	Fuse (A)	Contactor rated current (A)
GD18-0R7-4-2	10	10	9
GD18-1R5-4-2	16	16	18
GD18-2R2-4-2	25	25	25
GD18-004-4-2	40	40	38
GD18-5R5-4-2	50	50	50
GD18-7R5-4-2	63	70	50

## C.5 Reactors

When the voltage of the grid is high, the transient large current that flows into the input power circuit may damage rectifier components. You need to configure an AC reactor on the input side, which can also improve the current adjustment coefficient on the input side.

When the distance between the VFD and motor is longer than 50 m, the parasitic capacitance between the long cable and ground may cause large leakage current, and overcurrent protection of the VFD may be frequently triggered. To prevent this from happening and avoid damage to the motor insulator, compensation must be made by adding an output reactor. When the VFD is used to drive multiple motors, take the total length of the motor cables (that is, sum of the lengths of the motor cables) into account. When the total length is longer than 50 m, an output reactor must be added on the output side of the VFD. If the distance between the VFD and motor is 50 m to 100 m, select the reactor according to the following table. If the distance is longer than 100 m, contact INVT technical support.

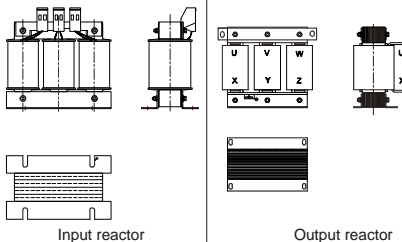

Input reactor

Output reactor

VFD model	Input reactor	Output reactor
GD18-0R7-4-2	ACL2-1R5-4	OCL2-1R5-4
GD18-1R5-4-2	ACL2-004-4	OCL2-1R5-4
GD18-2R2-4-2	ACL2-004-4	OCL2-2R2-4
GD18-004-4-2	ACL2-7R5-4	OCL2-004-4
GD18-5R5-4-2	ACL2-011-4	OCL2-5R5-4
GD18-7R5-4-2	ACL2-015-4	OCL2-7R5-4

**Note:**

- The rated input voltage drop of input reactors is 2%±15%.
- The rated output voltage drop of output reactors is 1%±15%.
- The preceding table lists external accessories. You need to specify the ones you choose when purchasing accessories.

**C.6 Filters****C.6.1 C3 filter model**

**FLT-P04003L-C-G**

A B C D E F G

Field	Description
A	FLT: VFD filter series
B	Filter type P: power supply filter L: output filter
C	Voltage class S2: AC 1PH 220V(-15%) - 240V(+10%) 04: AC 3PH 380V(-15%) - 440V(+10%)

Field	Description
D	3-digit development serial number. For example, 003 stands for the serial number of C3 filters in development.
E	Filter performance L: General H: High-performance
F	Filter application environment A: Environment Category I (IEC61800-3:2004), C1 (EN 61800-3:2004) B: Environment Category I (IEC61800-3:2004), C2 (EN 61800-3:2004) C: Environment Category II (IEC61800-3:2004), C3 (EN 61800-3:2004)
G	Market management number G: Special for external C3 filter

### C.6.2 C3 filter model selection

Goodrive18 series two-in-one VFD can meet IEC61800-3 C3 requirement only after connecting to an external filter.

VFD model	Input filter
GD18-0R7-4-2	FLT-P04006L-B
GD18-1R5-4-2	FLT-P04016L-B
GD18-2R2-4-2	FLT-P04016L-B
GD18-004-4-2	FLT-P04032L-B
GD18-5R5-4-2	FLT-P04032L-B
GD18-7R5-4-2	FLT-P04045L-B

The preceding table lists external accessories. You need to specify the ones you choose when purchasing accessories.

If you need C2 filters, consult INVT technical personnel for detailed configuration solutions.

## Appendix D Further information

### D.1 Product and service queries

If you have any queries about the product, contact the local INVT office. Provide the model and serial number of the product you query about. You can visit [www.invt.com](http://www.invt.com) to find a list of INVT offices.

### D.2 Feedback on INVT VFD manuals

Your comments on our manuals are welcome. Visit [www.invt.com](http://www.invt.com), directly contact online service personnel or choose **Contact Us** to obtain contact information.

### D.3 Documents on the Internet

You can find manuals in the PDF format and other product documents on the Internet. Visit [www.invt.com](http://www.invt.com) and choose **Service and Support > Data Download**. You can also scan the QR code labelled on the product to access the e-manual.



Service line: 86-755-23535967 E-mail: overseas@invt.com.cn Website: www.invt.com

The products are owned by **Shenzhen INVT Electric Co.,Ltd.**

Two companies are commissioned to manufacture: (For product code, refer to the 2nd/3rd place of S/N on the name plate.)

**Shenzhen INVT Electric Co.,Ltd.** (origin code: 01)

Address: INVT Guangming Technology Building, Songbai Road,  
Matian, Guangming District, Shenzhen, China

**INVT Power Electronics (Suzhou) Co.,Ltd.** (origin code: 06)

Address: No. 1 Kunlun Mountain Road, Science & Technology  
Town, Gaoxin District, Suzhou, Jiangsu, China

Industrial Automation:  HMI

Elevator Intelligent Control System

Energy & Power:

UPS

New Energy Vehicle Powerstain System

New Energy Vehicle Motor

PLC

VFD

Servo System

Rail Transit Traction System

DCIM

Solar Inverter

SVG

New Energy Vehicle Charging System



66001-00664