



Altivar Machine ATV320

Variable speed drives

Quick access to product information

Get technical information about your product

References

Modicon TM3
I/O expansion modules for Modicon controllers
Analog I/O modules

Number and type of channels	Input range	Output range	Resolution	Input format (internal (mA))	Reference	Weight (kg)
2 voltage measurement inputs	-15...+10 VDC 0...20 mA A, 20 mA	15.000 or 10.000 A sign	16 bits or 12 bits	0VDC 0VDC	TM3AI2H TM3AI2HG	0.110 0.200
4 voltage measurement inputs	-15...+10 VDC 0...20 mA A, 20 mA	15.000 or 10.000 A sign	16 bits or 12 bits	0VDC 0VDC	TM3AI4H TM3AI4HG	0.110 0.200
4 voltage measurement or temperature inputs (I ₁ , I ₂ , S, T, A, E, C) (RTD: Ni100, Ni1000, Pt100, Pt1000)	-15...+10 VDC 0...20 mA A, 20 mA	15.000 or 10.000 A sign	16 bits or 12 bits	0VDC 0VDC	TM3AI4T TM3AI4TG	0.110 0.200
4 differential temperature inputs (I ₁ , I ₂ , S, T, A, E, C) (RTD: Ni100, Ni1000, Pt100, Pt1000)	-15...+10 VDC 0...20 mA A, 20 mA	15.000 or 10.000 A sign	16 bits or 12 bits	0VDC 0VDC	TM3DI4T TM3DI4TG	0.110 0.200
8 self-measurement	-15...+10 VDC	15.000 or 10.000 A sign	16 bits or 12 bits	0VDC	TM3AI8	0.110

Share Price Global (English) My Products My Documents Partner Portal

Life Is On Schneider Electric

Search products, documents & more

PRODUCTS SOLUTIONS SERVICES SUPPORT ABOUT US

All products Industrial Automation and Control PLC, PAC and Dedicated Controllers Distributed Input/Output (I/O) Modules Modicon TM3

View all Modicon TM3

TM3AI2H

Module TM3 - 2 analog inputs high resolution

Show more characteristics >

Related Software >

Product Datasheet User guide Catalogue CAD Document

Characteristics Documents and Downloads Technical FAQs Additional Information Dimensions Drawings >>

Main

range of product Modicon TM3

product or component type Analog input module

range compatibility Modicon M251

Each commercial reference presented in a catalog contains a hyperlink. Click on it to obtain the technical information of the product:

- Characteristics, Dimensions and drawings, Mounting and clearance, Connections and schemas, Performance curves
- Product image, Instruction sheet, User guide, Product certifications, End of life manual

Find your catalog



- > With just 3 clicks, you can reach the Industrial Automation and Control catalogs, in both English and French
- > Download Digi-Cat with this [link](#)

Search Schneider Life Is On

Industrial Automation

General Catalog

Product Selector

360°

- Updated quarterly
- Embeds product selectors and configurators, 360° images, training centers,
- Optimized search by commercial reference

Select your training



- > Find the right [Training](#) for your needs on our Global website
- > Locate the training center with the selector tool, using this [link](#)

Training and courses

Training by domain of expertise

Electrical Installation and Safety Data Center Industrial Automation

General contents

Altivar Machine ATV320 variable speed drives

Introduction to EcoStruxure Machine page 2

Altivar Machine offer for Original Equipment Manufacturers (OEM) page 4

■ Altivar Machine ATV320 Variable speed drives

- Machine solution..... page 6
- Applications page 7
- Presentation page 7
- Innovative functions page 9
- The offer page 11
- Description page 13
- Standards and certifications page 13
- References
 - Drives with compact control block..... page 16
 - Drives with book control block page 17
 - Accessories page 18
 - Mounting accessories..... page 19
 - Replacement parts page 19

■ Options

- Dialog tools and configuration tools
 - DTM..... page 26
 - Simple Loader and Multi-Loader configuration tools page 27
 - Remote display terminal page 28
 - Remote graphic display terminal, accessories..... page 29
- Combinations: options for ATV320 drives
 - Drive with compact control block page 32
 - Drive with book control block page 36
 - Option modules page 36
- Braking resistors page 38
- Line chokes page 40
- Motor chokes page 41
- Additional EMC input filters page 42
- Option module adapter page 44
- Speed monitoring module..... page 45

■ Communication buses and networks

- Presentation page 46
- Functions page 47
- References
 - Modbus serial link page 47
 - CANopen machine bus..... page 48
 - Modbus TCP network and EtherNet/IP network page 50
 - PROFIBUS DP, DeviceNet bus, EtherCAT bus, POWERLINK network, ProfiNet network..... page 51

■ Motor starters page 52

■ Dimensions

- Altivar Machine ATV320 Variable speed drives
 - Drives with compact control block page 56
 - Drives with book control block..... page 59
- Line chokes, Motor chokes, Braking resistors, Additional EMC input filters..... page 61

■ Product reference index..... page 62

To be competitive in today's digital era, machine builders must be innovative. Smart machines, those that are better connected, more flexible, more efficient, and safe, are enabling machine builders to innovate in ways never before possible.

EcoStruxure, Schneider Electric's open, IoT-enabled architecture and platform, offers powerful solutions for the digital era. As part of this, EcoStruxure Machine brings powerful opportunities for machine builders and OEMs, empowering them to offer smart machines and compete in the new, digital era.

EcoStruxure Machine brings together key technologies for product connectivity and edge control on premises, and cloud technologies to provide analytics and digital services. EcoStruxure Machine helps you bring more innovation and added value to your customers throughout the entire machine life cycle.

Innovation at Every Level for Machines is full systems across three layers:

- Connected products
Our connected products for measuring, actuating, device level monitoring, and control adhere to open standards to provide unmatched integration opportunities and flexibility
- Edge Control
We are IIoT-ready with a proven set of tested and validated reference architectures that enable the design of end-to-end open, connected, and interoperable systems based on industry standards. Ethernet and OPC UA facilitates IT/OT convergence meaning machine builders reap benefits from web interfaces and cloud.

- Apps, Analytics & Services
Seamless integration of machines to the IT layer allows the collection and aggregation of data ready for analysis – for machine builders and end users alike this means increased uptime and the ability to find information faster for more efficient operations and maintenance.

These levels are completely integrated from shop floor to top floor. And we have cloud offers and end-to-end cybersecurity wrapped around.

EcoStruxure Machine makes it easier for OEMs/ machine builders to offer their customers smarter machines. The advent of smart machines is driven by the changing needs of end users:

- Evolving workforce
- Reducing costs
- Dynamic markets
- Shorter life cycles
- Prioritizing safety and cybersecurity

EcoStruxure Machine provides one solution for the whole machine life cycle:

- With Smart Design & Engineering the time to market is reduced by up to 30% using our automated engineering and the simulation capabilities
- During Commissioning & Operation of the machine, resources such as energy, material and loss can be improved, and with seamless integration to the IT world efficiency can be improved by up to 40%
- Smart Maintenance & Services reduces the time for corrective actions up to 50%

EcoStruxure™ Machine

Innovation At Every Level



* The Schneider Electric industrial software business and AVEVA have merged to trade as AVEVA Group plc, a UK listed company. The Schneider Electric and Life is On trademarks are owned by Schneider Electric and are being licensed to AVEVA by Schneider Electric.

Application segments	General
	Specific

Material handling, packaging, textiles, hoisting, mechanical actuators, material working
Conveyors, carton packers, gantry cranes, woodworking, metal processing, fans, etc.



Degree of protection	
Power range for 50..60 Hz supply	Single-phase 200...240V Three-phase 200...240V Three-phase 380...500V Three-phase 525...600V

IP20	IP20
0.18...2.2 kW/0.25... 3 HP	0.18...2.2 kW/0.25... 3 HP
0.18...15 kW/0.25...20 HP	-
0.37...15 kW/0.5...20 HP	0.37...15 kW/0.5...20 HP
0.75...15 kW/1...20 HP	-

Drive	Output frequency
	Control type Asynchronous motor
	Synchronous motor
	Motor sensor Integrated
	as an option
	Overload torque performance

0.1...599 Hz	-
U/F ratio (2 points, 5 points, energy saving, quadratic), Flux vector control without sensor (Standard and Energy saving)	
Vector control without sensor	
-	
RS422 (speed monitoring)	
Up to 200% Tn of over torque, and 170% tn of braking torque for open loop motor control	

Functions	Advanced functions
	Integrated safety functions
	Number of preset speeds

<ul style="list-style-type: none"> Control of asynchronous and synchronous motors; including IE2, IE3 and PM motors in open loop MachineStruxure integration in SoMachine Operation in Velocity mode and Torque control (with current limitation) Customizable and flexible application functions with ATV Logic (up to 50 function blocks) Numerous application functions for targeted application segments Embedded safety functions dedicated to targeted application segments 	
STO (up to SIL3 / PLe), SS1, SLS, SMS, GDL	
16	

Number of integrated I/O	Analog inputs
	Digital inputs
	Analog outputs
	Digital outputs
	Relay outputs
	Safety function inputs

3: 1 Bipolar differential ±10 V, 1 with Voltage 0...10 V and 1 with current (0-20 mA)
6: 4 configurable (positive or negative logic), 1 with PTC probe input, 1x20kHz pulse input
1: Configurable as voltage (0...10 V) or current (0-20 mA)
1: Configurable as sink or source
2: 1 with NO/NC contacts and 1 with NO contacts
1 + 4: 1 with STO and 4 configurable for safety functions from digital inputs

Communication	Integrated
	Optional

Single port compatible with CANopen and Modbus Serial line
Ethernet IP and Modbus TCP, CANopen RJ45 Daisy Chain, Sub-D, and screw terminals, PROFINET, Profibus DP V1, EtherCAT, DeviceNet and PowerLink

Configuration and runtime tools
--

Integrated Display, DTM (Device Type Manager), SoMove software, simple loader (optional), Multiloader(optional), and remote graphic terminal(optional).

Standards and certifications

IEC 61800-5-1, IEC 61800-3 (environments 1 and 2, category C2, C3), UL 508C, IEC 61800-5-2 up to SIL3 level, IEC 61508 up to SIL 3 level, IEC 13849-1 up to PLe level, IEC 60204-1, IEC 62061, EN 954-1 category 3, Draft standard EN 50495E, IEC 60721-3-3(Class 3C3,Class 3S2), EN/IEC 60068-2, IEC 60068-2-3, EN/IEC 61800-5-1, 86/188/EEC
CE, ATEX, UL 508C, UL61800-5-1, CSA 22.2 N274, NOM, GOST, EAC, CTICK, RCM, KC, SIL

References

ATV320●●●●●C	ATV320●●●●●B
--------------	--------------

Material handling, packaging, textiles, hoisting, mechanical actuators, material working
Conveyors, carton packers, gantry cranes, woodworking, metal processing, fans, etc.

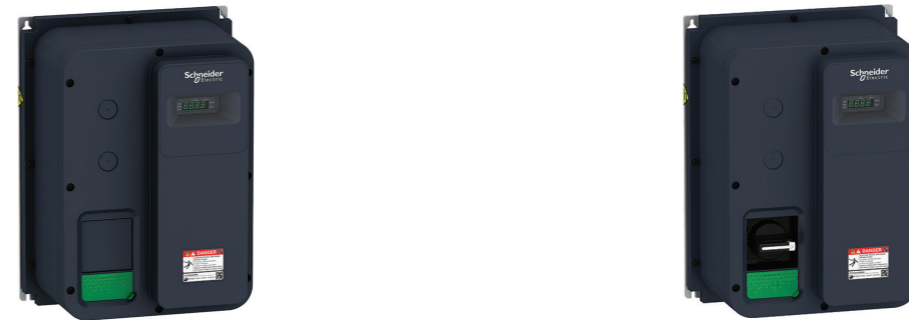

IP66	IP65
0.18...2.2 kW/0.25... 3 HP	0.18...2.2 kW/0.25... 3 HP
-	-
0.37...7.5 kW/0.5...10 HP	0.37...7.5 kW/0.5...10 HP
-	-

0.1...599 Hz	
U/F ratio (2 points, 5 points, energy saving, quadratic), Flux vector control without sensor (Standard and Energy saving)	
Vector control without sensor	
-	
RS422 (speed monitoring)	
Up to 200% Tn of over torque, and 170% tn of braking torque for open loop motor control	

<ul style="list-style-type: none"> Control of asynchronous and synchronous motors; including IE2, IE3 and PM motors in open loop MachineStruxure integration in SoMachine Operation in Velocity mode and Torque control (with current limitation) Customizable and flexible application functions with ATV Logic (up to 50 function blocks) Numerous application functions for targeted application segments Embedded safety functions dedicated to targeted application segments 	
STO (up to SIL3 / PLe), SS1, SLS, SMS, GDL	
16	

3: 1 Bipolar differential ±10 V, 1 with Voltage 0...10 V and 1 with current (0-20 mA)
6: 4 configurable (positive or negative logic), 1 with PTC probe input, 1x20kHz pulse input
1: Configurable as voltage (0...10 V) or current (0-20 mA)
1: Configurable as sink or source
2: 1 with NO/NC contacts and 1 with NO contacts
1 + 4: 1 with STO and 4 configurable for safety functions from digital inputs

Single port compatible with CANopen and Modbus Serial line
Ethernet IP and Modbus TCP, CANopen RJ45 Daisy Chain, Sub-D, and screw terminals, PROFINET, Profibus DP V1, EtherCAT, DeviceNet, and PowerLink

Integrated Display, DTM (Device Type Manager), SoMove software, simple loader (optional), Multiloader(optional), and remote graphic terminal(optional).

IEC 61800-5-1, IEC 61800-3 (environments 1 and 2, category C2, C3), UL 508C, IEC 61800-5-2 up to SIL3 level, IEC 61508 up to SIL 3 level, IEC 13849-1 up to PLe level, IEC 60204-1, IEC 62061, EN 954-1 category 3, Draft standard EN 50495E, IEC 60721-3-3(Class 3C3,Class 3S2), EN/IEC 60068-2, IEC 60068-2-3, EN/IEC 61800-5-1, 86/188/EEC
CE, ATEX, UL 508C, UL61800-5-1, CSA 22.2 N274, NOM, GOST, EAC, CTICK, RCM, KC, SIL

ATV320●●●●●W	ATV320●●●●●WS
--------------	---------------

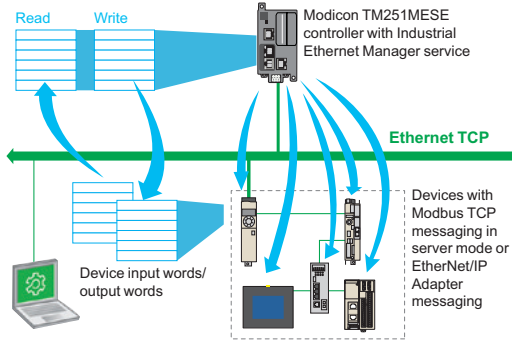

I/O Scanner (Industrial Ethernet Manager)

Advanced Variable Speed drive solution - Altivar 320

The Altivar Machine ATV320 provides IP20 and IP6x variable speed drive for three-phase synchronous and asynchronous motors in open loop control, and incorporates functions suitable for the most common applications, including:

- Torque and speed accuracy at very low speed, high dynamic performance with flux vector control without sensor.
- Extended frequency range for high-speed motors.
- Parallel connection of motors and special drives using voltage/frequency ratio.
- Static speed accuracy and energy saving for open-loop synchronous motors.

The Altivar Machine ATV320 series focus on easy integration for simple and advanced machine requirements with proven motor control and connectivity.

It offers enhanced automation capabilities and performance for industrial machine applications:

- Effective control of asynchronous and permanent magnet motors
- Complete integration into any system architecture (Ethernet, CANopen, Profibus, etc.)
- Compact and book format for integration in a variety of different cabinet types
- Integrated safety function for compliance with functional safety standards
- Enhanced resistance to polluted atmospheres

By taking account of constraints on product setup and use right from the design stage, Schneider Electric simplifies the integration of the Altivar Machine ATV320 drive into industrial machines. It features more than 150 functions. It is robust, easy to install, and compliant with the Machinery Directive 2006/42/EC.

ATV320 is fully integrated inside Schneider Electric's **EcoStruxure Machine** through DTM. PLCopen-compliant libraries. **EcoStruxure Machine** can be used to develop, configure, and set up an entire machine in a single software environment. Using FDT/DTM technology, it is possible to configure, control, and diagnose Altivar Machine ATV320 drives directly in SoMachine and SoMove software by means of the same software brick (DTM).

With seamless integration under this platform, Altivar Machine ATV320 benefits from the advantage of shorter engineering and design times. Optional Ethernet-based communication capability makes it accessible to production data at any level of automation system.

Applications

Altivar Machine ATV320 drives incorporate functions suitable for the most common applications, including:

Material handling

- Very quick response times on transmission of a command: 2 ms (± 0.5 ms)
- Reference via pulse input as analog input
- Control via built-in CANopen network or optional communication networks
- Position control via limit switches with time optimization at low speed
- Multiple parameter settings via parameter set switching
- Provide high protection version IP65/66 product, with/without vario switch

Hoisting

- Brake control adapted for horizontal and vertical movement
- Brake feedback management
- Load measurement using weight sensor
- High-speed hoisting with rope slack
- Limit switch management
- Dedicated speed monitoring function with optional card
- Multiple motors/configurations
- High speed switching function
- DC sharing and optional compact design regenerative braking unit



Material handling application



Hoisting application



Packing and packaging machines



Material working application



Textile application



Pumping

Applications (continued)

Packaging machines

- Up to 50 Hz of the bandwidth
- Control via built-in CANopen network or optional communication networks
- Book format enables to save space inside enclosure
- Advanced synchronous open loop control achieve energy saving performance
- Direct mounting of short circuit breaker on drive without wiring

Material working

- 5 integrated safety functions secure operation
- Control via built-in CANopen network or optional communication networks
- Fastest possible controlled stop on loss of line supply
- Motor thermal monitoring and protection function
- Torque limitation
- DC sharing and optional compact design regenerative braking unit(ATV regene)
- Very quick response times on transmission of a command: 2 ms (± 0.5 ms)
- 200% over torque ability, allow more dynamic response

Textile

- High protection degree version: IP65/IP66
- High resolution of the digital speed reference
- Use of synchronous motor, irrespective of load, helps to assure speed accuracy and energy saving
- High bandwidth with high-performance speed loop
- Spooling function/ Traverse control
- DC sharing and optional compact design regenerative braking unit
- Fastest possible controlled stop on loss of line supply secure continuous working machine
- Control via built-in CANopen network or optional communication networks
- Book format enables to save space inside enclosure

Pumping

- Dedicated motor control law for pumping and fan with optimized energy saving
- PID regulator with preset reference
- Multi motor parameter set
- ATV logic, programming function integrated in drive
- High protection degree enclosure
- Alarm management function
- Process load monitoring function
- Fault inhibition function, used in emergency situation such as smoke extraction.

General machine control

- ATV logic, programming function integrated in drive
- PID regulator
- 16 preset speed functions.
- Reference operation
- Line contactor and output contactor command
- Speed or torque control with current limitation
- Control via built-in CANopen network or optional communication networks
- DC bus management
- 6 motor control laws: Standard V/F, V/F 5 points, Sensorless vector control, Synchronous permanent magnet motors control, Variable torque, and Energy saving, allow user to adapt different machine behavior.

ATV320_63440_CPF16015C



ATV320_63440_CPF16031C



Presentation - ATV320 IP20 Product

The Altivar Machine ATV320 IP20 product is a variable speed drive for three-phase asynchronous and synchronous motors from 0.18 to 15 kW.

The Altivar Machine ATV320 drive is robust, simple to commission, and easy to integrate into different machine layouts and cabinets. It can also be integrated into commonly used automation architectures. Altivar Machine ATV320 variable speed drives are particularly suitable for applications involving simple industrial machines. Furthermore, Altivar Machine ATV320 embeds many practical functions so that advanced application requirements can be covered. Altivar Machine ATV320 is designed to improve machine performance and increase machine availability while reducing the total machine cost.

Flexible

There are 2 different formats for IP20 products, book and compact:

- The book format, 45 and 60 mm (1.77 and 2.63 in.) wide, is designed to be mounted side-by-side to save significant space on the installation foot print.
- The compact format, 72 to 180 mm (2.83 to 7.08 in.) wide, is designed to be integrated in compact electrical cabinets (200 mm (7.87 in.) cabinet depth or less) or mounted directly on the machine frame.

Advanced connectivity

Advanced connectivity allows the Altivar Machine ATV320 to operate in commonly used automation architectures; CANopen and Modbus RTU communication protocols are embedded and various communication fieldbus options are offered based on:

- Modbus TCP, EtherNet/IP, PROFINET, EtherCAT, POWERLINK
- Modbus serial link, CANopen, ProfibusDP, DeviceNet.

Robust design

Altivar Machine ATV320 variable speed drives can operate in harsh environment conditions:

- Up to 50 °C/122 °F without derating
- Up to 60 °C/140 °F with derating without the need for an additional fan

The printed circuit boards are coated according to IEC 60721-3-3 class 3C3 for industrial environments and 3S2 for solid particles.

Effective motor control

Control of both asynchronous and synchronous motors is both simple and effective. Altivar Machine ATV320 offers +/- 10% accuracy of motor slip in open-loop control with asynchronous motors.

Functions dedicated to synchronous motors

Altivar Machine ATV320 variable speed drives integrate new functions for synchronous motors that are suitable for the majority of commercially-available motors.

- Simplified setting due to the reduced number of configuration parameters (4 maximum)
- Autotuning of the drive/motor combination
- High-frequency injection for high performance in open-loop mode

As standard, Altivar Machine ATV320 drives support to drive synchronous motor in open loop control. This motor control law could help customer to reduce energy consumption.

Each ATV320 drive has a corresponding synchronous motor pre-selected in the SoMove software. User could select and order synchronous motor from the software easily and reduce time to design.

(1) The book format products are up to 4 kW and compatible supply voltages are 200-240V single phase and 380-500V three phase.



ATV320U02M2W



ATV320U02M2WS

Presentation - ATV320 IP66/65 Product

The Altivar Machine ATV320 IP66/65 drive is a variable speed drive for three-phase asynchronous and synchronous motors from 0.18 to 7.5kW. Altivar high IP offers **washable drives** for harsh environments, if users want to clean the dust & chemical pollution outside of drives. It meets EMC C2/C3 performance to suppress the emission effect on long cable application. ATV320 IP66/65 drive has **no external fan**, it reduces operational TOC site. ATV320 IP66/65 is heavy duty embedded from -10°C to 50°C for operational frequency (without derating below 4kHz switching frequency). **Integrated PLC and safety functions(SLS,SMS,SS1,GDL,STO)** save the automation setup cost of hybrid automation system which is widely applied in material handling segment. With flexibility and functionality, ATV320 IP66/65 is the only IP drives, that offers with **flexible panel building ability** to users.

Flexible

There are 2 different sizes for ATV320 IP66/65 products in W*H*D:

- Size 1: 250 mmx340 mmx182 mm (200 mm) (9.84 inx13.38 inx 7.16in) from 0.2kw to 4kW
- Size 2: 320 mm x 512 mm x 295 mm (335 mm) (12.59 inx 20.15inx 11.61in) from 5.5kw to 7.5kW

For higher IP protection offers enclosed with two types:

- IP66 drives without Vario disconnect switch
- IP65 drives with Vario disconnect switch

The IP66/65 drives provide higher environmental resistance, and open the possibility to design with the customized ground plate(VW3A9911 & VW3A9912) and front cover of the drive, also with 2 holes in the front reserved for integrating control and signaling units.

Altivar Machine ATV320 offers variety of supply possibilities:

- 200-240 V single phase: up to 2.2 kW
- 380-500 V three phase: up to 7.5kW

Advanced connectivity

Advanced connectivity allows the Altivar Machine ATV320 to operate in commonly used automation architectures; CANopen and Modbus RTU communication protocols are embedded and various communication fieldbus options are offered based on:

- Modbus TCP, EtherNet/IP, PROFINET, EtherCAT, POWERLINK
- Modbus serial link, CANopen, ProfibusDP, DeviceNet.

Robust design

Altivar Machine ATV320 variable speed drives can operate in harsh environment conditions:

- Up to 50 °C/122 °F without derating
- Up to 60 °C/140 °F with derating without the need for an additional fan

The printed circuit boards are coated according to IEC 60721-3-3 class 3C3 for industrial environments and 3S2 for solid particles.

Effective motor control

Control of both asynchronous and synchronous motors is both simple and effective. Altivar Machine ATV320 offers +/- 10% accuracy of motor slip in open-loop control with asynchronous motors.

Features dedicated for material handling solution

Simplified setting due to the reduced number of configuration parameters (4 maximum)

- 16 preset speed functions
- Multiple parameter settings via parameter set switching
- External fan-less design, 50°C without derating below.
- 3 analogue inputs, VSD can act as signal monitors.
- DC injection for fast stop
- DC bus connection to safe energy
- Jog operation
- PID regulator
- Positioning by limit switches or sensors
- Parameter switching
- Automatic restart



ATV320 with customized design



(1) For more information, please refer to the XB* catalog on our website: www.schneider-electric.com.

Innovative functions (1)

PF600367



Example of an application (scrolling billboard) requiring a typical ATV Logic sequence

Application functions

Altivar Machine ATV320 variable speed drives feature 150 functions, including:

- Configurations: standard or customizable
- Application-specific functions for material handling, textiles, hoisting, mechanical actuators
- Adjustable switching frequency (adjusted motor current, reduced motor noise)
- Adjustable monitoring function to create "My Menu" function to obtain user-specific monitoring
- Ability to upload/download drive configurations with the power off

ATV Logic

ATV Logic is used to adapt Altivar Machine ATV320 variable speed drives to specific applications by means of customizable integrated control system functions.

The integrated control system functions featuring ATV Logic can be used to perform simple operations without adding further devices, which reduces costs.

ATV Logic is programmed via the SoMove configuration software (refer to the SoMove catalog available on our website www.schneider-electric.com) and provides access to the following functions:

- Arithmetical operations, Boolean operators, counters, timers, etc.
- Programming of up to 50 functions by an automated sequence
- Access to the drive's internal variables
- Use internal function block such as timer, counter, and logic unit to achieve customized & advanced function as user wants.

Compatibility mode

ATV320 has a dedicate function of compatibility mode which enables customer to replace a legacy product ATV32 without changing PLC program. Machine builders will benefit for their maintenance and service request from their end users, regardless of the type of the network fieldbus connected. This function will reduced the down-time of machines and improved its productivity.

Safety functions

The Altivar Machine ATV320 range of variable speed drives provides integrated safety functions (according to standard IEC 61508) comparable with performance level "e" (PL e) according to standard ISO/EN 13849-1-2.

The Altivar Machine ATV320 drive software includes 5 safety functions that help machines meet safety requirements, whether or not they are used in conjunction with a Preventa safety module (2):

- STO: Safe Torque Off
- SLS: Safely Limited Speed
- SS1: Safe Stop 1
- SMS: Safe Maximum Speed
- GDL: Guard Door Locking

These safety functions are configured using SoMove configuration software.

For more information, please refer to the SoMove catalog available on our website www.schneider-electric.com.

Note: To set up the safety functions, please refer to the "Altivar Machine ATV320 Safety Functions Manual" available on our website www.schneider-electric.com.

(1) Non-exhaustive list; please consult our website www.schneider-electric.com.

(2) Please refer to our web site <http://www.schneider-electric.com/machinesafety>

PF600366



Example of an application requiring the use of safety functions

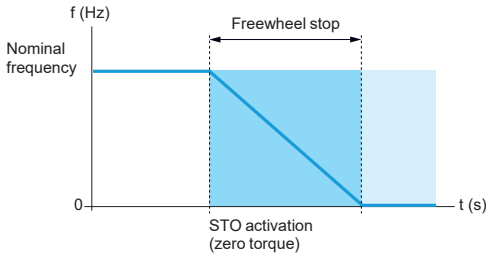

Activation of the STO safety function

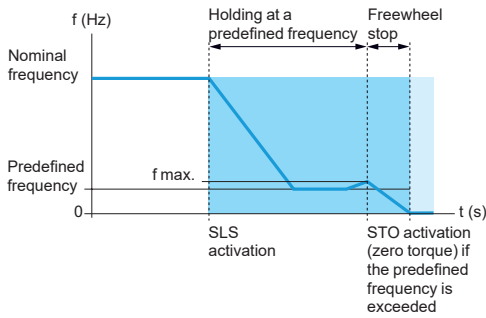

Activation of the SLS safety function

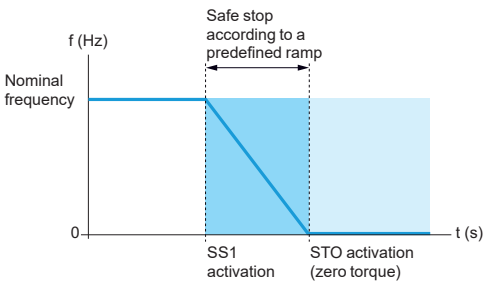

Activation of the SS1 safety function

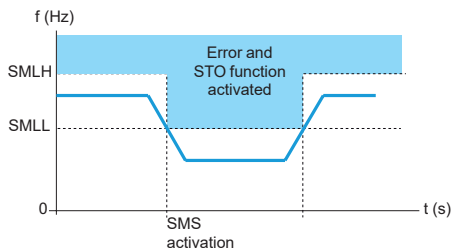

Activation of the SMS safety function

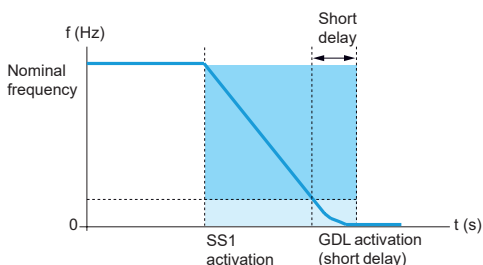

Activation of the GDL safety function (example of stop type SS1)

Integrated safety functions (1)

Safe Torque Off (STO) safety function

This function brings the machine safely into a no-torque state and/or prevents it from starting accidentally.

Safely Limited Speed (SLS) safety function

The SLS integrated safety function can be initiated by activation of safety function inputs. This function prevents the motor from exceeding the specified speed limit. If the motor speed exceeds the specified speed limit value, safety function STO is triggered.

Safe Stop 1 (SS1) safety function

The SS1 integrated safety function causes a category 1 safe stop. This function monitors the deceleration according to a dedicated deceleration ramp and safely shuts off the torque once standstill has been achieved.

Safe Maximum Speed (SMS) safety function

This function prevents the speed of the motor from exceeding the predefined speed limit.

- 2 different speed limits can be defined and can be selected by logic inputs.
- If the motor speed exceeds the predefined speed limit value, safety function STO is triggered.

Once the SMS function is configured, it is continuously active.

Guard Door Locking (GDL) safety function

This function allows you to release the guard door lock after specified delay when the motor power is turned off. The specified delay is chosen according to the type of stop.

The front door of the machine can be opened only after the motor is stopped; this function helps to ensure the safety of the machine operator.

Setting up the integrated safety functions

Setting up the integrated safety functions in the Altivar Machine ATV320 drive does not require any options or additional accessories.

The functions are connected directly to the drive's digital inputs and can only be configured using SoMove setup software.

For more information, please refer to the SoMove catalog available on our website www.schneider-electric.com.

(1) Please refer to the "Altivar Machine ATV320 Safety Functions Manual" available on our website www.schneider-electric.com.



ATV320U02M2C...U07M2C



ATV320U11M2C...U22M2C
ATV320U04N4C...U15N4C



ATV320U02M2B...U07M2B
ATV320U04N4B...U15N4B



ATV320U11M2B...U22M2B
ATV320U22N4B...U40N4B



ATV320U07N4W...U40N4W
ATV320U07N4WS...U40N4WS



ATV320U55N4W...U75N4W
ATV320U55N4WS...U75N4WS



CANopen communication module
with RJ45 connectors



CANopen communication module
with SUB-D connector



CANopen communication module
with connection via terminals

The offer

The Altivar Machine ATV320 range of variable speed drives covers motor power ratings from 0.18 kW/0.25 HP to 15 kW/20 HP with 4 types of power supply in book and compact control block design:

- 200 V...240 V single-phase, 0.18 kW/0.25 HP to 2.2 kW/3 HP (ATV320U●●M2B, ATV320U●●M2C, ATV320U●●M2W, ATV320U●●M2WS)
- 200 V...240 V three-phase, 0.18 kW/0.25 HP to 15 kW/20 HP (ATV320●●●M3C)
- 380 V...500 V three-phase, 0.37 kW/0.50 HP to 15 kW/20 HP (ATV320U●●N4C, ATV320●●●N4B)
- 380 V...500 V three-phase, 0.37 kW/0.50 HP to 7.5 kW/10 HP (ATV320●●●N4W, ATV320●●●N4WS)
- 525 V...600 V three-phase, 0.75 kW/1 HP to 15 kW/20 HP (ATV320●●●S6C)

References suffix meaning:

- Ending with "B" indicate that the product has a book control block
- Ending with "C" indicate that the product has a compact control block and a compact format (1)
- Ending with "W" indicate the IP66 drives without Vario Switch.
- Ending with "WS" indicate IP65 drives with Vario Switch.

Altivar Machine ATV320 drives integrate the Modbus and CANopen communication protocols as standard. Both can be accessed via the RJ45 connector on the front of the drive. To simplify connection of the Altivar Machine ATV320 drive to the CANopen machine bus, 3 dedicated communication modules are available with different connectors:

- CANopen Daisy Chain module with 2 RJ45 connectors
- CANopen module with 9-way SUB-D connector
- CANopen module with 5-way terminal block

In addition to the Modbus and CANopen standard protocols, Altivar Machine ATV320 drives can be connected to the main industrial communication buses and networks by adding one of the following optional communication modules:

- Modbus/TCP - Ethernet/IP
- PROFIBUS DP V1
- DeviceNet
- EtherCAT
- POWERLINK
- PROFINET

Integrated EMC filters

Altivar 320, have built-in EMC filter in ATV320U●●M2B, ATV320U●●M2C, ATV320●●●N4B, ATV320●●●N4C and ATV320●●●W● drives to meet the EMC standard.

Drive	Maximum length of shielded cable (2)/(3) according to	
	IEC/EN 61800-3 Category C2	IEC/EN 61800-3 Category C3
ATV320●●●M2●	10	10
ATV320U04N4C...U15N4C	10	10
ATV320U22N4C...U40N4C	10	20
ATV320U04N4B...U15N4B	5	5
ATV320U22N4B...U40N4B	10	20
ATV320U55N4●...U75N4●	2	20
ATV320D11N4●...D15N4●	–	30
ATV320U02M2W●...U22M2W●	10	10
ATV320U04N4W●...U75N4W●	10	10

The EMC filter enables compliance with standard IEC/EN 61800-3, category C2 or C3 in environment 1 or 2 and to comply with the European Electromagnetic Compatibility Directive (EMC).

- (1) For the book format, several drives can be mounted side-by-side to save space.
 (2) If motors are connected in parallel, it is the total cable length that should be taken into account.
 (3) The maximum motor cable lengths is at 4 kHz switching frequency.

EMC standard description				
IEC 61800-3 Category	C1	C2	C3	C4
Environment	1st environment	1st or 2nd environment (choice of the user)	2nd environment	2nd environment
Supply voltage/current	< 1000 V	–	–	> 1000 V, or > 400 A or IT supply network
Knowledge and requirement	No requirements	Installation and commissioning by EMC expert only	EMC plan required	–

The EMC filter enables compliance with standard IEC/EN 61800-3, category C2 or C3 in environment 1 or 2 and to comply with the European Electromagnetic Compatibility Directive (EMC).

EMC standards		
Category	Subcategory	Test standard
Emission	Radiated noise	CISPR11 (EN55011)
	Conducted noise	CISPR11 (EN55011)
Immunity	Electrostatic Discharge (ESD) test	IEC61000-4-2
	Radioactive radio-frequency magnetic contactor field	IEC61000-4-3
	Electrical fast transient (EFT)/burst transients test	IEC61000-4-4
	Electrical Surge Test	IEC61000-4-5
	Immunity to conducted disturbances induced by radio-frequency fields	IEC61000-4-6
	Voltage dip/interruption of power	IEC61000-4-11

IEC 60068-2	
Description	Test and endurance standards
Temperature test	IEC 60068-2-2
Vibration test	IEC 60068-2-6
Schock test	IEC 60068-2-27
Shake test	IEC 60068-2-29

The offer (continued)

Accessories and external options

Accessories and external options are available with Altivar Machine ATV320 drives. The type of external accessories and options depends on the drive rating.

Accessories

- UL Type 1 conformity kits, plates for direct mounting on 35 mm/1.38 in. rails, etc.
- Bracket for direct mounting of GV2/ATV320U●●●●B circuit breaker
- Adapter for mounting the control module at 90°, for mounting the power module on its side, keeping the control module visible and accessible
- Daisy chain DC bus cordsets for daisy chain connection of the DC bus

External options

- Braking resistors
- Line chokes
- Motor chokes
- Additional EMC filters
- Adapter extension module for compact control block drive
- Speed monitoring module

Dialog and configuration tools

Human-Machine interface

The 4-digit display **1** shows drive states, error codes, and parameter values. The navigation button **2** is used to navigate through the menus, modify values, and change the motor speed in local mode.

HMI terminals

Altivar Machine ATV320 drives can be connected to a graphic display terminal (VW3A1111, VW3A1101) **3** or a remote display terminal **4**, which are available as options.

The HMI terminals can be mounted on an enclosure door with IP65 degree of protection. They provide the same level of access as the on-board Human-Machine interface.

The HMI terminal display in the majority of user languages, and provide a user-friendly environment for configuration, debugging or maintenance.

SoMove setup software

SoMove setup software is used to configure, adjust, debug (using the Oscilloscope function), and maintain Altivar Machine ATV320 drives in the same way as for other Schneider Electric drives and starters.

For more information, please refer to the SoMove catalog available on our website www.schneider-electric.com.

Simple Loader and Multi-Loader configuration tools

The Simple Loader tool **6** enables the configuration from one powered-up drive to be duplicated on another powered-up drive.

The Multi-Loader tool **5** enables configurations from a PC or drive to be copied and duplicated on another drive; the drives do not need to be powered up.

7 Direct cable connection doesn't affect Certification & Protection degree (IP level). Green bar: Advanced configuration tool

The advanced keypad tool **5** enables configurations from a PC or drive to be copied and duplicated on another drive, also support for REMOTE/LOCAL operation.

See [page 19](#).

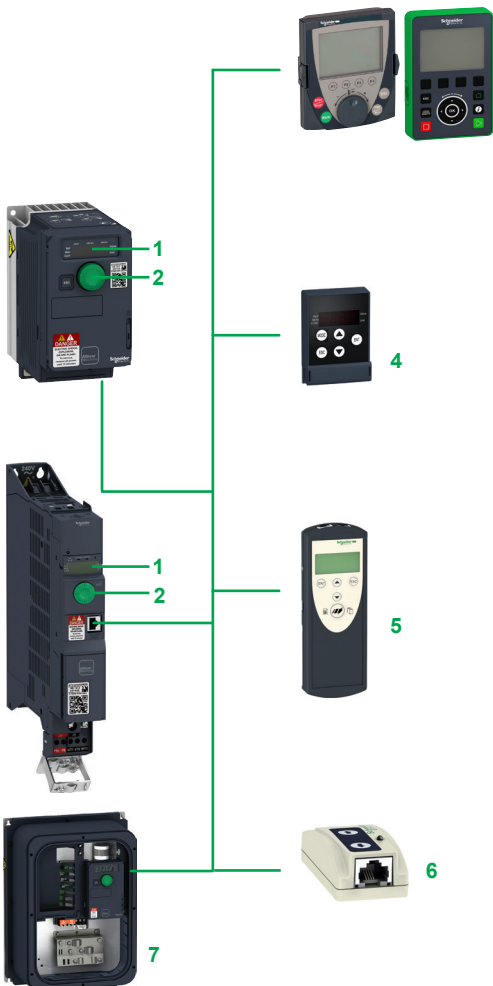

ATV320 dialog and configuration tools

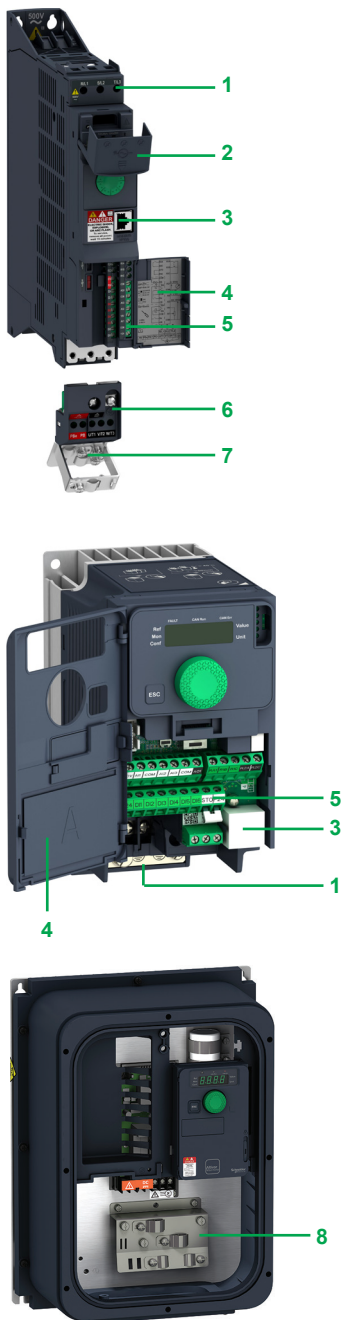

Description

- 1 Power terminals
 - 2 Protective cover to block access to the power terminals 1 when closed
 - 3 RJ45 communication port for access to integrated protocols: Modbus serial link and CANopen machine bus
 - 4 Protective cover for access to the control terminals (also includes a label with a wiring diagram)
 - 5 Control terminals for I/O connection:
 - 6 digital inputs:
 - 4 configurable for positive digital input (Sink) or negative digital input (Source)
 - 1 input configurable as a PTC probe input
 - 1 x 20 kHz pulse control input, 24 V $\overline{\text{---}}$, impedance 3.5 k Ω , sampling time 8 ms
 - 1 digital output:
 - 24 V $\overline{\text{---}}$, sampling time 2 ms, maximum voltage 30 V, maximum current 100 mA
 - 3 analog inputs:
 - 1 current analog input, by programming X and Y from 0 to 20 mA, impedance 250 Ω
 - 1 bipolar differential analog input ± 10 V, impedance 30 k Ω
 - 1 voltage analog input 0...10 V $\overline{\text{---}}$, impedance 30 k Ω , sampling time 2 ms
 - 1 analog output configurable as:
 - voltage analog output 0...10 V $\overline{\text{---}}$, minimum load impedance 470 Ω
 - current analog output 0...20 mA, maximum load impedance 800 Ω
 - 2 relay outputs:
 - 1 NC contact and 1 NO contact with common point
- Minimum switching capacity 5 mA for 24 V $\overline{\text{---}}$, maximum switching capacity 3 A on resistive load, 2 A on inductive load for 250 V \sim or 30 V $\overline{\text{---}}$
- 1 NO contact, maximum switching capacity 5 A on resistive load
 - 6 Removable motor power terminal block (allows quick disconnect and re-connect of motor cables during maintenance operations)
 - 7 EMC mounting plate (integral part of the motor power terminal block 6). This plate is supplied with a cable guide support, which can be used if required.
 - 8 Direct cable connection doesn't affect Certification & Protection degree (IP level).

Standards and certifications (1)

Altivar Machine ATV320 drives have been developed to conform to the strictest international standards and recommendations relating to industrial electrical control devices (IEC), in particular:

- IEC 61800-5-1
- IEC 61800-3:
- EMC immunity: IEC 61800-3, Environments 1 and 2
- Conducted emission compliance:
 - IEC 61800-3, category C2, C3 with integrated EMC filter for ATV320●M2●, ATV320●N4W●, ATV320U04N4●●●●D15N4● drives
 - IEC 61800-3, category C1, C2, C3 with additional EMC filter for ATV320●N4●, ATV320●M2● drives
- ISO/EN 13849-1/-2 category 3 (PL d)
- IEC 61508 (parts 1 & 2)
- IEC 60721-3-3 classes 3C3 and 3S2

Altivar Machine ATV320 drives are certified:

- CE - LV EMC
- CE - Machine
- ATEX
- UL 508C
- UL61800-5-1
- CSA 22.2 N274
- NOM
- GOST
- EAC
- CTICK
- RCM
- KC
- SIL

They are CE marked according to the European low voltage (2014/35/UE) and EMC (2014/30/UE) directives.

They also comply with environmental directives (RoHS).

(1) A complete list of certifications and characteristics is available on our website www.schneider-electric.com.

Variable speed drives

Altivar Machine ATV320

Drives with compact control block, IP20



ATV320U02M2C...U07M2C



ATV320U11M2C...U22M2C
ATV320U04N4C...U15N4C



ATV320U22N4C...
ATV320U40N4C



ATV320U55M3C

Drives with compact control block											
Motor Power indicated on rating plate (1)	Line supply				Altivar Machine ATV320					Reference (1)	Weight
	Max. line current (2) (3)	Apparent power		Max. prospective line Isc (4)	Max. continuous output current (In) (1)	Max. transient current for 60s	Power dissipated at maximum output current (In) (1)				
	at U1	at U2	at U2		A	A	W			kg/lb	
Single-phase supply voltage: 200...240 V 50/60 Hz, with integrated EMC filter (6)											
0.18	0.25	3.4	2.8	0.7	1	1.5	2.3	17	ATV320U02M2C	0.800/1.278	
0.37	0.5	5.9	4.9	1.2	1	3.3	5	30	ATV320U04M2C	1.000/2.204	
0.55	0.75	7.8	6.6	1.6	1	3.7	5.6	33	ATV320U06M2C	1.100/2.425	
0.75	1	10.0	8.4	2	1	4.8	7.2	45	ATV320U07M2C		
1.1	1.5	13.7	11.5	2.8	1	6.9	10.4	61	ATV320U11M2C	1.600/3.527	
1.5	2	17.8	14.9	3.6	1	8	12	76	ATV320U15M2C		
2.2	3	24.0	20.2	4.8	1	11	16.5	99	ATV320U22M2C		
Three-phase supply voltage: 200...240 V 50/60 Hz, without integrated EMC filter											
0.18	0.25	2.0	1.7	0.7	5	1.5	2.3	15	ATV320U02M3C	0.800/1.278	
0.37	0.5	3.6	3.0	1.2	5	3.3	5	27	ATV320U04M3C	0.900/1.984	
0.55	0.75	4.9	4.2	1.7	5	3.7	5.6	31	ATV320U06M3C	1.000/2.204	
0.75	1.0	6.3	5.3	2.2	5	4.8	7.2	42	ATV320U07M3C		
1.1	1.5	8.6	7.2	3.0	5	6.9	10.4	58	ATV320U11M3C	1.400/3.086	
1.5	2.0	11.1	9.3	3.9	5	8	12	72	ATV320U15M3C		
2.2	3.0	14.9	12.5	5.2	5	11	16.5	91	ATV320U22M3C		
3.0	3.0	18.7	15.7	6.5	5	13.7	20.6	105	ATV320U30M3C	2.200/4.850	
4.0	5.0	23.8	19.9	8.3	5	17.5	26.3	140	ATV320U40M3C		
5.5	7.5	35.4	29.8	12.4	22	27.5	41.3	242	ATV320U55M3C	3.500/7.716	
7.5	10.0	45.3	38.2	15.9	22	33	49.5	293	ATV320U75M3C	3.600/7.937	
11.0	15.0	60.9	51.4	21.4	22	54	81	468	ATV320D11M3C	6.800/14.991	
15.0	20.0	79.7	67.1	27.9	22	66	99	551	ATV320D15M3C	6.900/15.212	

(1) These values are given for a nominal switching frequency of 4 kHz, for use in continuous operation. The switching frequency is adjustable from 2 to 16 kHz. Above 4 kHz, derate the nominal drive current. The nominal motor current should not exceed this value (see derating curves).

(2) Typical value for a 4-pole motor and a maximum switching frequency of 4 kHz, with no line choke for max.

(3) Nominal supply voltage, min. U1, max. U2: 200 (U1)...240 V (U2), 380 (U1)...500 V (U2), 525(U1)...600(U2).

(4) If line Isc is greater than the values in the table, add line chokes.

Variable speed drives

Altivar Machine ATV320

Drives with compact control block, IP20



ATV320U07S6C



ATV320U15S6C



ATV320U55N4C

Drives with compact control block

Motor		Line supply				Altivar Machine ATV320				Reference (1)	Weight
Power indicated on rating plate (1)	Max. line current (2) (3)	Apparent power		Max. prospective line Isc (4)	Max. continuous output current (In) (1)	Max. transient current for 60s	Power dissipated at maximum output current (In) (1)				
		at U1	at U2					at U2	W		
kW	HP	A	A	kVA	kA	A	A	W		kg/lb	
Three-phase supply voltage: 380...500 V 50/60 Hz, with integrated EMC filter (5) (6)											
0.37	0.5	2.1	1.6	1.4	5	1.5	2.25	23		ATV320U04N4C	1.200/2.866
0.55	0.75	2.8	2.2	1.9	5	1.9	2.85	27		ATV320U06N4C	2.646
0.75	1	3.6	2.8	2.4	5	2.3	3.45	32		ATV320U07N4C	
1.1	1.5	5	3.8	3.3	5	3	4.5	40		ATV320U11N4C	1.300/2.866
1.5	2	6.4	4.9	4.2	5	4.1	6.15	56		ATV320U15N4C	
2.2	3	8.7	6.6	5.7	5	5.5	8.25	74		ATV320U22N4C	2.100/4.630
3	3	11.1	8.4	7.3	5	7.1	10.65	93		ATV320U30N4C	
4	5	13.7	10.6	9.2	5	9.5	14.25	111		ATV320U40N4C	2.200/4.850
5.5	7.5	20.7	14.5	12.6	22	14.3	21.45	195		ATV320U55N4C	2.200/4.850
7.5	10.0	26.5	18.7	16.2	22	17.0	25.5	229		ATV320U75N4C	2.200/4.850
11.0	15.0	36.6	25.6	22.2	22	27.7	41.6	370		ATV320D11N4C	6.800/14.991
15.0	20.0	47.3	33.3	28.8	22	33.0	49.5	452		ATV320D15N4C	6.900/15.211
Three-phase supply voltage: 525...600 V 50/60 Hz, without integrated EMC filter (7)											
0.75	1	1.5	1.4	1.5	5	1.7	2.6	34		ATV320U07S6C	1.300/2.866
1.5	2	2.6	2.4	2.5	5	2.7	4.1	54		ATV320U15S6C	
2.2	3	3.7	3.2	3.4	5	3.9	5.9	77		ATV320U22S6C	2.000/4.409
4	5	6.5	5.8	6.0	5	6.1	9.2	96		ATV320U40S6C	2.500/5.511
5.5	7.5	8.4	7.5	7.8	22	9.0	13.5	148		ATV320U55S6C	3.500/7.716
7.5	10	11.6	10.5	10.9	22	11.0	16.5	175		ATV320U75S6C	
11	15	15.8	14.1	14.7	22	17.0	25.5	267		ATV320D11S6C	6.500/14.330
15	20	22.1	20.1	20.9	22	22.0	33.0	317		ATV320D15S6C	

(1) These values are given for a nominal switching frequency of 4 kHz, for use in continuous operation. The switching frequency is adjustable from 2 to 16 kHz. Above 4 kHz, derate the nominal drive current. The nominal motor current should not exceed this value (see derating curves).

(2) Typical value for a 4-pole motor and a maximum switching frequency of 4 kHz, with no line choke for max.

(3) Nominal supply voltage, min. U1, max. U2: 200 (U1)...240 V (U2), 380 (U1)...500 V (U2), 525 (U1)...600 (U2).

(4) If line Isc is greater than the values in the table, add line chokes.

(5) Drives supplied with category C2 integrated EMC filter. This filter can be disconnected.

(6) Drives are supplied with an EMC plate, for assembly by the customer.

(7) A line choke is mandatory with ATV320●●●S6C drives. To be ordered separately, see page 40.

Variable speed drives

Altivar Machine ATV320

Drives with book control block, IP20



ATV320U02M2B...U07M2B
ATV320U04N4B...U15N4B



ATV320U11M2B...U22M2B
ATV320U22N4B...U40N4B



ATV320U55N4B



ATV320D15N4B

Drives with book control block											
Motor		Line supply				Altivar Machine ATV320				Reference (1)	Weight
Power indicated on rating plate (1)		Max. line current (2),(3)		Apparent power	Max. prospective line Isc (4)	Max. continuous output current (In) (1)	Max. transient current for 60s	Power dissipated at maximum output current (In) (1)			
		at U1	at U2						at U2		
kW	HP	A	A	kVA	kA	A	A	W	kg/lb		
Single-phase supply voltage: 200...240 V 50/60 Hz, with integrated EMC filter (5) (6)											
0.18	0.25	3.4	2.8	0.7	1	1.5	2.3	19	ATV320U02M2B	2.400/5.291	
0.37	0.5	6	5	1.2	1	3.3	5	31	ATV320U04M2B	2.500/5.511	
0.55	0.75	7.9	6.7	1.6	1	3.7	5.6	35	ATV320U06M2B		
0.75	1	10.1	8.5	2	1	4.8	7.2	46	ATV320U07M2B	2.400/5.291	
1.1	1.5	13.6	11.5	2.8	1	6.9	10.4	62	ATV320U11M2B	2.900/6.393	
1.5	2	17.6	14.8	3.6	1	8	12	77	ATV320U15M2B		
2.2	3	23.9	20.1	4.8	1	11	16.5	98	ATV320U22M2B		
Three-phase supply voltage: 380...500 V 50/60 Hz, with integrated EMC filter (5) (6)											
0.37	0.5	2.1	1.6	1.4	5	1.5	2.3	23	ATV320U04N4B	2.500/5.511	
0.55	0.75	2.8	2.2	1.9	5	1.9	2.9	27	ATV320U06N4B	2.600/5.732	
0.75	1	3.6	2.7	2.3	5	2.3	3.5	31	ATV320U07N4B		
1.1	1.5	5	3.8	3.3	5	3	4.5	41	ATV320U11N4B	2.500/5.511	
1.5	2	6.5	4.9	4.2	5	4.1	6.2	56	ATV320U15N4B		
2.2	3	8.7	6.6	5.7	5	5.5	8.3	74	ATV320U22N4B	3.000/6.614	
3	3	11.1	8.4	7.3	5	7.1	10.7	93	ATV320U30N4B		
4	5	13.7	10.5	9.1	5	9.5	14.3	111	ATV320U40N4B		
5.5	7.5	20.7	14.5	12.6	22	14.3	21.45	195	ATV320U55N4B	7.500/16.534	
7.5	10	26.5	18.7	16.2	22	17	25.5	229	ATV320U75N4B		
11	15	36.6	25.6	22.2	22	27.7	41.6	370	ATV320D11N4B	8.700/19.180	
15	20	47.3	33.3	28.8	22	33	49.5	452	ATV320D15N4B	8.800/19.401	

(1) These values are given for a nominal switching frequency of 4 kHz, for use in continuous operation. The switching frequency is adjustable from 2 to 16 kHz. Above 4 kHz, derate the nominal drive current. The nominal motor current should not exceed this value (see derating curves).

(2) Typical value for a 4-pole motor and a maximum switching frequency of 4 kHz, with no line choke for max. prospective line Isc (4).

(3) Nominal supply voltage, min. U1, max. U2: 200 (U1)...240 V (U2), 380 (U1)...500 V (U2), 525 (U1)...600 V (U2).

(4) If line Isc is greater than the values in the table, add line chokes.

(5) Drives supplied with category C2 integrated EMC filter. This filter can be disconnected.

(6) Connection in compliance with EMC standards:

- ATV320●●●M2B, ATV320U04N4B...ATV320U40N4B drives are supplied with an EMC plate. This is integral part of the power terminal; these 2 components cannot be separated.

- ATV320U55N4B...D15N4B drives are supplied with an EMC plate, for assembly by the customer.

Variable speed drives

Altivar Machine ATV320

IP66 drive without Vario and IP65 drive with Vario

ATV320_63440_CPMGU18024



ATV320U02M2W
...U40N4W

ATV320_63440_CPMGU17055B



ATV320U55N4W,
ATV320U75N4W

ATV320_63440_CPMGU17058C



ATV320U02M2WS
...U40N4WS

ATV320_63440_CPMGU17060B



ATV320U55N4WS,
ATV320U75N4WS

Drives for harsh environment IP66/IP65										
Motor		Line supply				Altivar Machine ATV320				
Power indicated on rating plate (1)	Max. line current (2) (3)	Apparent power		Max. prospective line Isc (4)	Max. continuous output current (In) (1)	Max. transient current for 60s	Power dissipated at maximum output current (In) (1)	Reference (1)	Weight	
		at U1	at U2							
kW	HP	A	A	kVA	kA	A	A	W		kg/lb
Single-phase supply voltage: 200...240 V 50/60 Hz, with integrated EMC filter, IP66 (5)										
0.18	0.25	3.4	2.8	0.7	1	1.5	2.3	17	ATV320U02M2W	5.000/11.023
0.37	0.5	5.9	4.9	1.2	1	3.3	5	30	ATV320U04M2W	5.100/11.243
0.55	0.75	7.8	6.6	1.6	1	3.7	5.6	33	ATV320U06M2W	
0.75	1	10	8.4	2	1	4.8	7.2	45	ATV320U07M2W	
1.1	1.5	13.7	11.5	2.8	1	6.9	10.4	61	ATV320U11M2W	7.400/16.314
1.5	2	17.8	14.9	3.6	1	8	12	76	ATV320U15M2W	
2.2	3	24	20.2	4.8	1	11	16.5	99	ATV320U22M2W	
Three-phase supply voltage: 380...500 V 50/60 Hz, with integrated EMC filter, IP66 (5)										
0.37	0.5	2.1	1.6	1.4	5	1.5	2.3	23	ATV320U04N4W	5.900/13.007
0.55	0.75	2.8	2.2	1.9	5	1.9	2.9	27	ATV320U06N4W	
0.75	1	3.6	2.8	2.4	5	2.3	3.5	32	ATV320U07N4W	
1.1	1.5	5	3.8	3.3	5	3	4.5	40	ATV320U11N4W	6.000/13.227
1.5	2	6.4	4.9	4.2	5	4.1	6.2	56	ATV320U15N4W	
2.2	3	8.7	6.6	5.7	5	5.5	8.3	74	ATV320U22N4W	7.700/16.975
3	3	11.1	8.4	7.3	5	7.1	10.7	93	ATV320U30N4W	
4	5	13.7	10.6	9.2	5	9.5	14.3	111	ATV320U40N4W	7.800/17.196
5.5	7.5	20.7	14.5	12.6	22	14.3	21.5	195	ATV320U55N4W	22.000/48.501
7.5	10	26.5	18.7	16.2	22	17.0	25.5	229	ATV320U75N4W	
Single-phase supply voltage: 200...240 V 50/60 Hz, with integrated EMC filter, IP65, with vario (5)										
0.18	0.25	3.4	2.8	0.7	1	1.5	2.3	17	ATV320U02M2WS	5.400/11.904
0.37	0.5	5.9	4.9	1.2	1	3.3	5	30	ATV320U04M2WS	5.500/12.125
0.55	0.75	7.8	6.6	1.6	1	3.7	5.6	33	ATV320U06M2WS	5.500/12.125
0.75	1	10.0	8.4	2.0	1	4.8	7.2	45	ATV320U07M2WS	
1.1	1.5	13.7	11.5	2.8	1	6.9	10.4	61	ATV320U11M2WS	7.800/17.196
1.5	2	17.8	14.9	3.6	1	8	12	76	ATV320U15M2WS	
2.2	3	24.0	20.2	4.8	1	11	16.5	99	ATV320U22M2WS	
Three-phase supply voltage: 380...500 V 50/60 Hz, with integrated EMC filter, IP65, with vario (5)										
0.37	0.5	2.1	1.6	1.4	5	1.5	2.3	23	ATV320U04N4WS	6.300/13.889
0.55	0.75	2.8	2.2	1.9	5	1.9	2.9	27	ATV320U06N4WS	
0.75	1	3.6	2.8	2.4	5	2.3	3.5	32	ATV320U07N4WS	
1.1	1.5	5.0	3.8	3.3	5	3	4.5	40	ATV320U11N4WS	6.400/14.109
1.5	2.0	6.4	4.9	4.2	5	4.1	6.2	56	ATV320U15N4WS	
2.2	3.0	8.7	6.6	5.7	5	5.5	8.3	74	ATV320U22N4WS	8.100/17.857
3.0	3.0	11.1	8.4	7.3	5	7.1	10.7	93	ATV320U30N4WS	
4.0	5.0	13.7	10.6	9.2	5	9.5	14.3	111	ATV320U40N4WS	8.200/18.077
5.5	7.5	20.7	14.5	12.6	22	14.3	21.5	195	ATV320U55N4WS	22.700/50.044
7.5	10.0	26.5	18.7	16.2	22	17.0	25.5	229	ATV320U75N4WS	

(1) These values are given for a nominal switching frequency of 4 kHz, for use in continuous operation. The switching frequency is adjustable from 2 to 16 kHz. Above 4 kHz, derate the nominal drive current. The nominal motor current should not exceed this value (see derating curves).
 (2) Typical value for a 4-pole motor and a maximum switching frequency of 4 kHz, with no line choke for max. prospective line Isc (4).
 (3) Nominal supply voltage, min. U1, max. U2: 200 (U1)...240 V (U2), 380 (U1)...500 V (U2).
 (4) If line Isc is greater than the values in the table, add line chokes.
 (5) Drives supplied with category C2 integrated EMC filter. This filter can be disconnected.

ATV320_63440_OFF16047



GV2 / ATV320 direct mounting: **GV2L08** + **(VW3A9921 + GV2AF5)** + **ATV320U07N4B**

Accessories

Description	For use with	Minimum order quantity	Reference	Weight kg/lb
Components for mounting GV2 circuit breaker directly on ATV320 drive				
Bracket for GV2/ATV320 direct mounting Mechanical bracket for holding the GV2 circuit breaker in place when directly mounted on the ATV320 drive. Requires a GV2AF5 adapter plate for electrical connection, to be ordered separately.	ATV320●●●M2B ATV320U04N4B...U40N4B	10	VW3A9921	0.075/ 0.165
Adapter plate Provides the electrical link between the GV2 circuit breaker and the ATV320 drive when the GV2 is directly mounted on the ATV320. Requires a VW3A9921 bracket for direct mounting, to be ordered separately.	ATV320●●●M2B ATV320U02N4B...U40N4B	10	GV2AF5	0.016/ 0.035
GV2 adaptor metal sheet	ATV320●●●M2W ATV320U04N4W...U40N4W	1	VW3A9922	5.900/ 13.007
UL type 4X kit Indoor UL type 4X kit, support for harsh environment usage.	ATV320U02M2W..U40N4W ATV320U55N4W..U75N4W		VW3A9923X VW3A9924X	0.15/ 0.33

Mounting the control module at 90°

Adapter for mounting the control module at 90° This is used to mount the power module on the side, keeping the control module visible and accessible.	ATV320●●●M2B ATV320U04N4B...U40N4B	1	VW3A9920	0.125/ 0.276
---	---------------------------------------	---	-----------------	-----------------

Daisy chain connection of the DC bus (1)

The DC bus is connected in a daisy chain in the following cases:

- Drives powered by the AC supply with parallel connection of the DC bus in order to balance the loads during braking phases between the drives; used in addition to braking resistors (see [page 38](#))
- Drives powered by the DC bus only

Requires the connection accessories listed below:

Description	Use		Length m/ft	Sold in lots of	Unit Reference	Weight kg/lb
	From	To				
Cordset (1) equipped with 2 connectors	ATV320●●●M2B	ATV320●●●M2B	0.1/ 0.33	5	VW3M7101R01	–
	ATV320●●●N4B	ATV320●●●N4B				
Shielded cable	ATV320●●●M2●	ATV320●●●M2●	15/ 49.21	1	VW3M7102R150	–
	ATV320●●●N4●	ATV320●●●N4●				
	ATV320●●●M3C	ATV320●●●M3C				
	ATV320●●●S6C	ATV320●●●S6C				
Connection kit for VW3M7102R150 cable	–	–	–	10	VW3M2207	–

(1) Setting up several devices on the DC bus requires special precautions; please refer to the installation manual available on our website www.schneider-electric.com.

PF06070A



VW3A980●

Accessories (continued)

Shielding connection clamp

Description	For use with	Sold in lots of	Unit Reference	Weight kg/lb
Shielding connection clamps Attachment and earthing of the cable shielding Pack of 25 clamps including: for the cable length of 10 ■ 20 clamps for Ø 4.8 mm (0.19 in.) cable ■ 5 clamps for Ø 7.9 mm (0.31 in.) cable	ATV320●●●●●●	25	TM200RSRCMC	—

DIN rail mounting kit

Description	For use with	Reference	Weight kg/lb
Plates for mounting on DIN rail width 35 mm (1.38 in.)	ATV320U02M●C...	VW3A9804	0.290/ 0.639
	ATV320U07M●C	VW3A9805	0.385/ 0.849
	ATV320U11M●C...		
	ATV320U22M●C		
	ATV320U04N4C...		
	ATV320U15N4C		
	ATV320U07S6C...		
	ATV320U15S6C		

(1) Setting up several devices on the DC bus requires special precautions; please refer to the installation manual available on our website www.schneider-electric.com.

Accessories (continued)			
Description	For use with	Reference	Weight kg/ lb
UL Type 1 conformity kits Mechanical device for attaching to the lower part of the drive. For direct connection of cables to the drive via tubes or cable glands.	ATV320U02M2C...U07M2C ATV320U02M3C...U07M3C	VW3A95811	0.370/ 0.816
	ATV320U11M2C...U22M2C ATV320U04N4C...U15N4C ATV320U07S6C...U15S6C	VW3A95812	0.440/ 0.970
	ATV320U11M3C...U22M3C	VW3A95813	0.480/ 1.058
	ATV320U22N4C...U40N4C ATV320U22S6C...U40S6C	VW3A95814	0.550/ 1.213
	ATV320U30M3C...U40M3C	VW3A95815	0.580/ 1.279
	ATV320U55M3C...U75M3C ATV320U55N4C...U75N4C ATV320U55S6C...U75S6C	VW3A95816	0.820/ 1.808
	ATV320U55N4B...U75N4B	VW3A95817	1.410/ 3.109
	ATV320D11M3C...D15M3C ATV320D11N4C...D15N4C ATV320D11S6C...D15S6C	VW3A95818	1.160/ 2.557
	ATV320D11N4B...D15N4B	VW3A95819	1.680/ 3.704

Mounting accessories				
Description	For drives	Reference	Weight kg/ lb	
EMC conformity kits These provide a connection compliant with EMC standards (for further information, please consult our website www.schneider-electric.com). The kit consists of: ■ The EMC plate ■ Clamps ■ Fixing accessories	ATV320U02M3C ATV320U04M3C ATV320U06M3C ATV320U07M3C	VW3A9523	0.170/ 0.374	
	ATV320U11M3C ATV320U15M3C ATV320U22M3C ATV320U07S6C ATV320U15S6C	VW3A9524	0.190/ 0.418	
	ATV320U30M3C ATV320U40M3C ATV320U22S6C ATV320U40S6C	VW3A9525	0.210/ 0.462	
	ATV320U55M3C...U75M3C ATV320U55N4C...U75N4C ATV320U55S6C...U75S6C	VW3A9532	0.200/ 0.440	
	ATV320D11M3C...D15M3C ATV320D11N4C...D15N4C ATV320D11S6C...D15S6C	VW3A9533	0.260/ 0.573	
	EMC conformity kits	ATV320●●●M2W ATV320●●●M2WS ATV320U04N4W...U40N4W ATV320U04N4WS...U40N4WS	VW3A9535	–
		ATV320U55N4W...U75N4W ATV320U55N4WS...U75N4WS	VW3A9536	–
	Full gland plate *Panel builder to modify	ATV320●●●M2W ATV320●●●M2WS ATV320U04N4W...U40N4W ATV320U04N4WS...U40N4WS	VW3A9911	–
		ATV320U55N4W...U75N4W ATV320U55N4WS...U75N4WS	VW3A9912	–

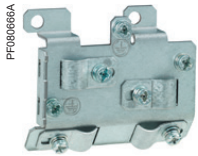

VW3A9523



VW3A9524

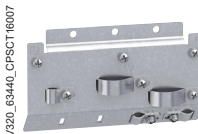

VW3A9525

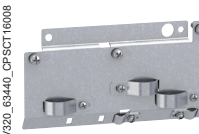

VW3A9532



VW3A9911

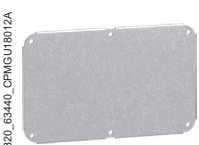

VW3A9912

Variable speed drives

Altivar Machine ATV320

Replacement parts

F19_VENTILATION_CPODA2016002

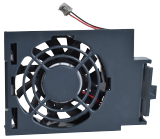

VZ3V1301

Replacement parts			
Description	For use with	Reference	Weight kg/ lb
Fans			
Fan for variable speed drive	ATV320U11M3C...U40M3C	VZ3V1302	
	ATV320U11M2C...U22M2C ATV320U04N4C...U15N4C ATV320U07S6C...U15S6C	VZ3V1301	
	ATV320U02M2B...U07M2B ATV320U04N4B...U15N4B	VZ3V32A100	
	ATV320U11M2B...U22M2B ATV320U22N4B...U40N4B	VZ3V32B100	
	ATV320U22N4C...U40N4C ATV320U22S6C...U40S6C	VZ3V320S3	
	ATV320U55M3C...U75M3C ATV320U55N4B...U75N4B ATV320U55N4C...U75N4C ATV320U55S6C...U75S6C	VZ3V32C100	
	ATV320D11M3C...D15M3C ATV320D11N4B...D15N4B ATV320D11N4C...D15N4C ATV320D11S6C...D15S6C	VZ3V32D100	
	ATV320U04N4W...U15N4W ATV320U04N4WS...U15N4WS ATV320U11M2W...U22M2W ATV320U11M2WS...U22M2WS	VZ3V32066S2	
	ATV320U22N4W...U40N4W ATV320U22N4WS...U40N4WS	VZ3V32066S3	
	ATV320U55N4W...U75N4W ATV320U55N4WS...U75N4WS	VZ3V32066S4	
Other			
Removable motor power terminal block	ATV320U02M2B...U40N4B	VY1F32AB1001	
Pluggable fan connector	ATV320U02M2B...D15N4B ATV320●●●M2W● ATV320●●●N4W●	VY1F10007V21	
I/O control card	ATV320●●●●●C ATV320●●●M2W● ATV320●●●N4W●	VW3A36201	

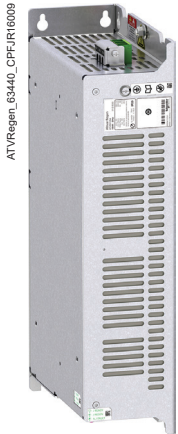

ATVRD15N4

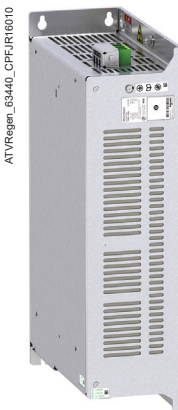

ATVRU75N4

Presentation

The main function of the ATV Regen product is to provide an option to regenerate energy back to the AC supply for heavy braking applications such as Material Working, Material Handling and Hoisting with easy setting.

This option should be associated with Altivar drives in the 400 V series such as Altivar 320. The braking unit harmonic performance is the same as that of standard drives.

Features:

- Chemical class 3C3 conforming to IEC/EN 60721
- Mechanical class 3S2 conforming to IEC/EN 60721
- -10..50 °C/14...122 °F without derating, up to 60 °C/140 °F with derating
- Mechanical class 3S2 conforming to IEC/EN 60721
- Built in EMC filter comply with standard IEC 61800-3

Wiring concept

Generic wiring

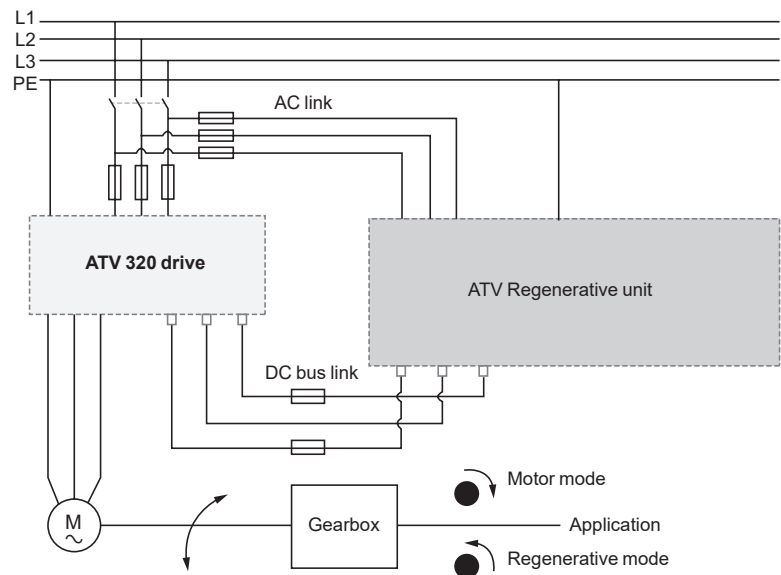



[Click to download
Altivar Regenerative Unit: Sizing Tool](#)

Wiring concept (continued)

Several drives with one Regenerative unit

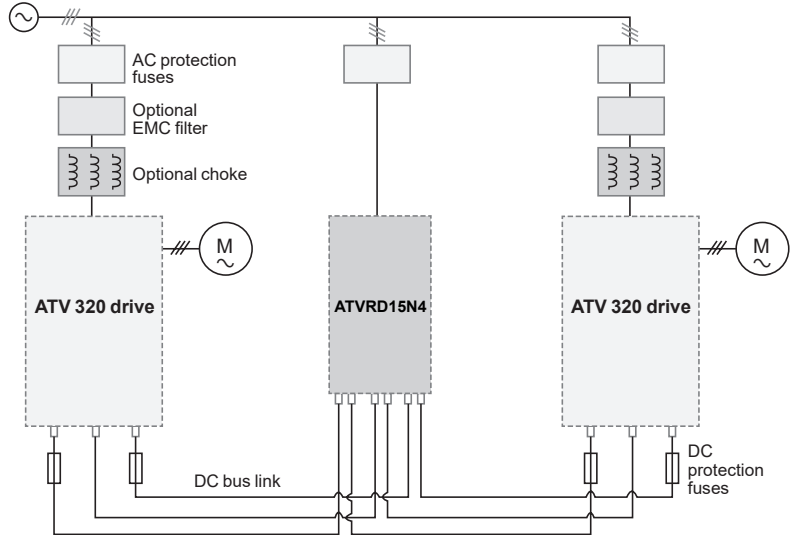

References

For drives (1)	IP	Regenerative unit reference	Weight kg/ lb
Supply voltage: 380...480 V 50/60 Hz			
ATV320U07N4●...U75N4●	20	ATVRU75N4	6.000/ 13.228
ATV320D11N4●...D15N4●	20	ATVRD15N4	11.500/ 25.353

(1) The sizing selection should refer to Altivar Regenerative unit, user manual

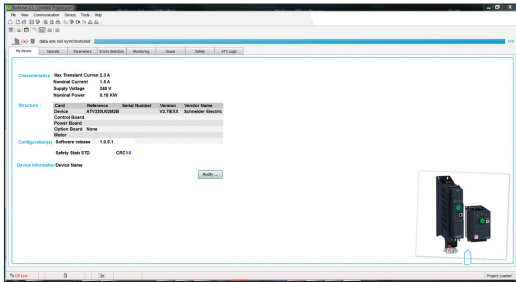

Altivar Machine DTM in SoMove software

DTM

Presentation

Using DTM technology it is possible to configure, control, and diagnose Altivar Machine drives directly in SoMachine and SoMove software by means of the same software brick (DTM).

DTM technology standardizes the communication interface between field devices and host systems. The DTM contains a uniform structure for managing drive access parameters.

The Altivar Machine ATV320 DTM library is a flexible, open, and interactive tool that can be used in a third-party FDT.

DTMs can be downloaded from our website www.schneider-electric.com.

Specific functions of the Altivar Machine ATV320 DTM

- Offline or online access to drive data
- Transfer of configuration files from and to the drive
- Customization (My Menu)
- Access to drive parameters and option cards
- Oscilloscope function
- Graphic interface to assist with configuration of the Altivar Machine ATV320
- Drive parameter monitoring
- Detected error and warning logs

Advantages of the DTM library in EcoStruxure Machine

SoMachine software is a single tool for configuration, setup, and diagnostics for the complete machine. It can be integrated in the fieldbus topology.

SoMachine additionally offers Function Block library possibilities for Altivar Machine drives.

Advantages of the DTM library in SoMove

SoMove is a drive-oriented software environment.

It allows a wired connection directly to the drive Modbus serial port.

SoMove setup software

SoMove Lite setup software for PC is used to prepare drive configuration files.

The USB/RJ45 cable (reference TCSCMCNAM3M002P) connects to the USB port of the PC running software and to the RJ45 port on the device.

For more information, refer to the SoMove catalog available on our website www.schneider-electric.com.

PF030829



VW3A8121

PF030828



VW3A8120

ATV320_03440_OPFI0048



Configuring an Altivar 320 in its packaging:
VW3A8121 + VW3A8126 cordset

Simple Loader and Multi-Loader configuration tools

The Simple Loader tool enables one drive configuration to be duplicated and transferred to another drive (both drives must be powered up). It is connected to the drive RJ45 communication port.

The Multi-Loader tool enables a number of configurations from a PC or drive to be copied and loaded onto other drives (Altivar Machine ATV320 drives do not need to be powered up when using the Multi-Loader tool).

References

Description	Reference	Weight kg/lb
Simple Loader configuration tool Supplied with a cordset equipped with 2 RJ45 connectors	ATV320●●●● VW3A8120	—
Multi-Loader configuration tool Supplied with: <ul style="list-style-type: none"> - 1 cordset equipped with 2 RJ45 connectors - 1 cordset equipped with one type A USB connector and one mini B USB connector - 1 SD memory card - 1 female/female RJ45 adapter - 4 AA/LR6 1.5 V batteries - 1 anti-shock protector - 1 carrying handle 	ATV320●●●● VW3A8121	—
Cordset for Multi-Loader tool For connecting the Multi-Loader tool to the Altivar 320 drive in its packaging. Equipped with a non-locking RJ45 connector with special mechanical catch on the drive end and an RJ45 connector on the Multi-Loader end.s	ATV320●●●● VW3A8126 in its packaging	—
USB/RJ45 cable equipped with a USB connector and an RJ45 connector. For connecting a PC to the Altivar Machine ATV320. Length: 2.5 m (8.20 ft.)	ATV320●●●● TCSMCNAM3M002P	—



Remote display terminal with cover open



Remote display terminal with cover closed

Remote display terminal

This terminal is used to locate the Human-Machine Interface of the Altivar Machine ATV320 drive remotely on the door of an enclosure with IP 54 or IP 65 protection degree.

It is used to:

- Control, adjust, and configure the drive remotely
- Display the drive status and error codes

Its maximum operating temperature is 50 °C/122 °F.

Description

- 1 4-digit display
- 2 Navigation ▲, ▼ and selection ENT, ESC keys
- 3 Motor local control keys:
 - RUN: Starts the motor
 - FWD/REV: Reverses the direction of rotation of the motor
 - STOP/RESET: Stops the motor/clears detected errors
- 4 MODE: Operating mode selection key
- 5 Cover for access to the motor local control keys

References

Description	Degree of protection	Length	Reference	Weight
				kg/lb
Remote display terminals				
A remote-mounting cordset, VW3A1104R●●, is also required	IP 54	–	VW3A1006	0.250/ 0.551
	IP 65	–	VW3A1007	0.275/ 0.606
Remote-mounting cordsets	–	1.0/ 3.28	VW3A1104R10	0.050/ 0.110
equipped with 2 RJ45 connectors		3.0/ 9.84	VW3A1104R30	0.150/ 0.331



Remote graphic display terminal



Portable use of the remote graphic display terminal: 1 + 2 + 3

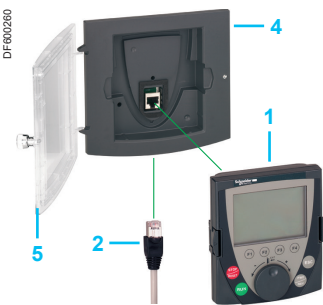

Using the remote graphic display terminal on enclosure door: 1 + 2 + 4 (+ 5, if IP 65)

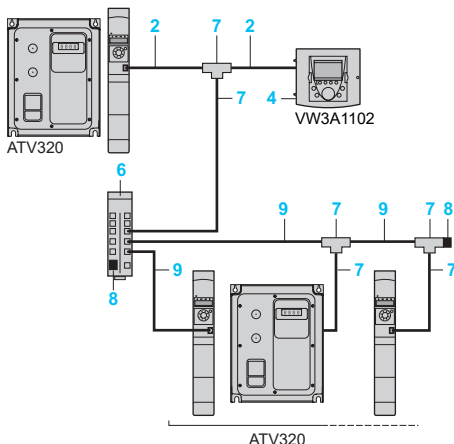

Example of connection via multidrop link

Remote graphic display terminal

This remote graphic display terminal, common across Schneider Electric's variable speed drive ranges, provides a user-friendly interface for configuration, debugging, and maintenance. In particular, it is possible to transfer and store up to 4 configurations. For portable use or mounted on an enclosure door, it can also be connected to multiple drives (see page 28).

Its main functions are as follows:

- The graphic screen displays 8 lines of 24 characters of plain text.
- The navigation button provides quick and easy access to the drop-down menus.
- It is supplied with 6 languages installed (Chinese, English, French, German, Italian, and Spanish). The available languages can be modified using the Multi-Loader configuration tool (VW3A8121).

Its maximum operating temperature is 60 °C/140 °F, and it features IP 54 protection degree this can be increased to IP 65 when mounted on an enclosure door.

Description

- 1 Graphic display: 8 lines of 24 characters, 240 x 160 pixels, large digit display
- 2 Function keys (not operational on the Altivar 320)
- 3 **Navigation button:**
 - Rotate ±: Goes to the next/previous line, increases/decreases the value
 - Press: Saves the current value (**ENT**)
 - **ESC** key: Aborts a value, parameter, or menu to return to the previous selection
- 4 Motor local control keys:
 - **RUN**: Starts the motor
 - **STOP/RESET**: Stops the motor/clears detected errors
 - **FWD/REV**: Reverses the direction of rotation of the motor

References

Item no.	Description	Length m/ft	Reference	Weight kg/lb
1	Remote graphic display terminal A remote-mounting cordset, VW3A1104R●●●, and an RJ45 adapter, VW3A1105, are required	–	VW3A1101	0.180/0.396
2	Remote-mounting cordsets equipped with 2 RJ45 connectors Remote operation of the ATV320 and the remote graphic display terminal VW3A1101	1.0/3.28	VW3A1104R10	0.050/0.110
		3.0/9.84	VW3A1104R30	0.150/0.331
		5.0/16.40	VW3A1104R50	0.250/0.551
		10/32.81	VW3A1104R100	0.500/1.102
3	Female/female RJ45 adapter	–	VW3A1105	0.010/0.022
4	Remote mounting kit For mounting on enclosure door IP 54 degree of protection	–	VW3A1102	0.150/0.331
5	Door Used to increase the degree of protection for remote mounting kit VW3A1102 to IP 65 To be mounted on remote mounting kit VW3A1102	–	VW3A1103	0.040/0.088

Additional accessories for multidrop connection

Item no.	Description	Unit reference	Weight kg/lb	
6	Modbus splitter box: 10 RJ45 connectors and 1 screw terminal block	LU9GC3	0.500/1.102	
7	Modbus T-junction boxes With integrated cable (0.3 m/0.98 ft)	VW3A8306TF03	–	
		VW3A8306TF10	–	
8	Modbus line terminator For RJ45 connector R = 120 Ω, C = 1 nf	VW3A8306RC	0.010/0.022	
		sold by lots of 2		
Item no.	Description	Length m/ft	Reference	Weight kg/lb
9	Cordsets for Modbus serial link equipped with 2 RJ45 connectors	0.3/0.98	VW3A8306R03	0.025/0.055
		1/3.28	VW3A8306R10	0.060/0.132
		3/9.84	VW3A8306R30	0.130/0.287

Example of connection via multidrop link

All the components described on this page enable a remote graphic display terminal to be connected to several drives via a multidrop link. This multidrop link is connected to the RJ45 port on the Modbus/CANopen communication port. See the example opposite.

PF130809



Graphic display terminal VW3A1111

ATV340_63441_CPSCT16025



Detected fault: Red screen when there is a detected error

Graphic display terminal

This terminal can be:

- Connected and mounted on an enclosure door using a remote-mounting accessory
- Connected to a PC to exchange files via a Mini USB/USB connection (1)
- Connected to several drives in multidrop mode (see [page 29](#))

This terminal is used to:

- Control, adjust, and configure the drive
- Display current values (motor, I/O, and machine data)
- Display graphic dashboards such as the energy consumption monitoring dashboard
- Store and download configurations (several configuration files can be stored in the 16 MB memory)
- Duplicate the configuration of one powered-up drive on another powered-up drive
- Copy configurations from a PC or drive and duplicate them on another drive (the drives should be powered on for the duration of the duplication operations)

Other characteristics:

- Up to 24 languages (complete alphabets) covering the majority of countries around the world (languages can be removed, added and updated according to user needs; please consult our website www.schneider-electric.com)
- 2-color backlit display (white and red); if an error is detected, the red backlight is activated automatically (function can be disabled)
- Operating range: $-15...50\text{ }^{\circ}\text{C}/+5...122\text{ }^{\circ}\text{F}$
- Degree of protection: IP 65
- The Multipoint Screen feature of the Graphic Display Terminal VW3A1111 must not be used with ATV320.
- The behavior of configuration tool is similar as VW3A1101, for more information please check ATV320 programming manual

Description

This Graphic Display Terminal is a local control unit which can be either plugged on the drive or mounted on the door of the wall-mounted or floor-standing enclosure. It has a cable with connectors, which is connected to the drive front Modbus serial link.

- STOP / RESET: Stop command / apply a Fault Reset.
- LOCAL / REMOTE: used to switch between local and remote control of the drive if one of the function keys displays [T/K] (FT), otherwise the key is unused.
- **NOTE: To assign a function key (F1...F4) to the function LOCAL/REMOTE, go to [Command] (CTL-) menu and assign [F1 key assignment] (FN1) or ... or [F4 key assignment] (FN4) to [T/K] (FT).**
- ESC: used to quit a menu/parameter or remove the currently displayed value in order to revert to the previous value retained in the memory.
- F1 to F4: function keys used to access quick view, and submenus. Simultaneous press of F1 and F4 keys generates a screenshot file in the Graphic Display Terminal internal memory.
- Graphic display.
- Home: Used to access directly at the home page if the Graphic Display Terminal displays "Quick" on one of its function keys.
- Information: used to show the code of menus, submenus, and parameters if the Graphic Display Terminal displays "Code" on one of its function keys.
- RUN: executes the function assuming it has been configured.
- Touch wheel / OK: used to save the current value or access the selected menu/parameter. The touch wheel is used to scroll fast into the menus. Up/down arrows are used for precise selections, right/left arrows are used to select digits when setting a numerical value of a parameter.
- RJ45 Modbus serial port: used to connect the Graphic Display Terminal to the drive in remote control.
- Mini USB port: used to connect the Graphic Display Terminal to a computer.
- Battery (10 years service life. Type: CR2032). The battery positive pole points to the front face of the Graphic Display Terminal.

References

Description	Reference	Weight kg/ lb
Graphic display terminal	VW3A1111	0.200/ 0.441

(1) Graphic display terminal used only as a handheld terminal.

(2) For ATV320 and VW3A111 firmware compatibility, please refer to Programming manual.



Remote-mounting kit for mounting graphic display terminal on enclosure door (front panel)

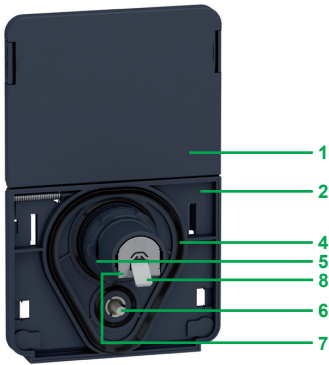

Remote-mounting kit for graphic display terminal (rear panel)

Accessories for graphic display terminal

- Remote-mounting kit for mounting on enclosure door with IP 65/UL Type 12 degree of protection as standard

The kit comprises:

- Tightening tool (also sold separately under the reference ZB5AZ905)

- Cover plate to maintain IP 65 protection when there is no terminal connected
- Mounting plate
- RJ45 port for the graphic display terminal
- Seal
- Fixing nut
- Anti-rotation pin
- RJ45 port for connecting the remote-mounting cordset (10 m/32.81 ft maximum)
Cordsets should be ordered separately depending on the length required.
- Grounding connector

Drilling a hole with a standard $\varnothing 22$ tool, as used for a pushbutton, allows the unit to be mounted without the need for a cut-out in the enclosure ($\varnothing 22.5$ mm/ $\varnothing 0.89$ in. drill hole).

References

Description	Length m/ ft	IP	Reference	Weight kg/ lb
Remote-mounting kit Order with remote-mounting cordset VW3A1104R●●●	–	65/UL Type 12	VW3A1112	–
Tightening tool for remote-mounting kit	–	–	ZB5AZ905	0.016/ 0.035
Remote-mounting cordset equipped with 2 RJ45 connectors	1/ 3.28	–	VW3A1104R10	0.050/ 0.110
	3/ 9.84	–	VW3A1104R30	0.150/ 0.331
	5/ 16.40	–	VW3A1104R50	0.250/ 0.551
	10/ 32.81	–	VW3A1104R100	0.500/ 1.102
IP 65 remote-mounting kit for Ethernet port (1) $\varnothing 22$ RJ45 female/female adapter with seal	–	65	VW3A1115	0.200/ 0.441

Configuration tools

Connection accessories

Description	Length m/ ft	Reference	Weight kg/ lb
SoMove setup software For configuring, adjusting and debugging the Altivar Machine drive.	–	(2)	–
USB/RJ45 cable equipped with a USB connector and an RJ45 connector. For connecting a PC to the drive. Length: 2.5 m	2.5/ 8.20	TCSMCNAM3M002P	–

(1) Graphic display terminal used only as a handheld terminal.

(2) For ATV320 and VW3A111 firmware compatibility, please refer to Programming manual.

Variable speed drives

Altivar Machine ATV320

Combinations of options for Altivar 320 drives, IP20, compact format

Combinations of options for Altivar 320 drives																
Motor		Drive	Accessories					Options								
			UL Type 1 conformity kits	Fan for variable speed drive	Shielding connection clamps	DIN rail kit	EMC conformity kits	Braking resistors			Line chokes	Motor chokes	Additional EMC filters	Communication adapter card		
kW	HP									IP20	IP65 - 0.75 m/ 29.53 in. cable	IP65 - 3 m/ 118.11 in. cable				
Drive with compact control block - single-phase supply voltage: 200...240 V 50/60 Hz																
0.18	0.25	ATV320U02M2C	VW3A95811	-	TM200RSRCEMC	VW3A9804	-	-	VW3A7730	VW3A7608R07	VW3A7608R30	-	VW3A4552	VW3A31401	VW3A3600	
0.37	0.5	ATV320U04M2C	VW3A95811	-	TM200RSRCEMC	VW3A9804	-	-	VW3A7730	VW3A7608R07	VW3A7608R30	-	VW3A4552	VW3A31401	VW3A3600	
0.55	0.75	ATV320U06M2C	VW3A95811	-	TM200RSRCEMC	VW3A9804	-	-	VW3A7731	VW3A7608R07	VW3A7608R30	VZ1L007UM50	VW3A4552	VW3A31401	VW3A3600	
0.75	1	ATV320U07M2C	VW3A95811	-	TM200RSRCEMC	VW3A9804	-	-	VW3A7731	VW3A7608R07	VW3A7608R30	VZ1L007UM50	VW3A4552	VW3A31401	VW3A3600	
1.1	1.5	ATV320U11M2C	VW3A95812	VZ3V1301	TM200RSRCEMC	VW3A9805	-	-	VW3A7731	VW3A7605R07	VW3A7605R30	VZ1L018UM20	VW3A4552	VW3A31403	VW3A3600	
1.5	2	ATV320U15M2C	VW3A95812	VZ3V1301	TM200RSRCEMC	VW3A9805	-	-	VW3A7731	VW3A7605R07	VW3A7605R30	VZ1L018UM20	VW3A4552	VW3A31403	VW3A3600	
2.2	3	ATV320U22M2C	VW3A95812	VZ3V1301	TM200RSRCEMC	VW3A9805	-	-	VW3A7732	VW3A7603R07	VW3A7603R30	VZ1L018UM20	VW3A4553	VW3A31405	VW3A3600	
Drive with compact control block - three-phase supply voltage: 200...240 V 50/60 Hz																
0.18	0.25	ATV320U02M3C	VW3A95811	-	TM200RSRCEMC	VW3A9804	VW3A9523	-	VW3A7730	VW3A7608R07	VW3A7608R30	VW3A4551	VW3A4552	VW3A31402	VW3A3600	
0.37	0.5	ATV320U04M3C	VW3A95811	-	TM200RSRCEMC	VW3A9804	VW3A9523	-	VW3A7730	VW3A7608R07	VW3A7608R30	VW3A4551	VW3A4552	VW3A31402	VW3A3600	
0.55	0.75	ATV320U06M3C	VW3A95811	-	TM200RSRCEMC	VW3A9804	VW3A9523	-	VW3A7731	VW3A7608R07	VW3A7608R30	VW3A4551	VW3A4552	VW3A31402	VW3A3600	
0.75	1	ATV320U07M3C	VW3A95811	-	TM200RSRCEMC	VW3A9804	VW3A9523	-	VW3A7731	VW3A7608R07	VW3A7608R30	VW3A4551	VW3A4552	VW3A31402	VW3A3600	
1.1	1.5	ATV320U11M3C	VW3A95813	VZ3V1302	TM200RSRCEMC	VW3A9805	VW3A9524	-	VW3A7731	VW3A7605R07	VW3A7605R30	VW3A4552	VW3A4552	VW3A31404	VW3A3600	
1.5	2	ATV320U15M3C	VW3A95813	VZ3V1302	TM200RSRCEMC	VW3A9805	VW3A9524	-	VW3A7731	VW3A7605R07	VW3A7605R30	VW3A4552	VW3A4552	VW3A31404	VW3A3600	
2.2	3	ATV320U22M3C	VW3A95813	VZ3V1302	TM200RSRCEMC	VW3A9805	VW3A9524	-	VW3A7732	VW3A7603R07	VW3A7603R30	VW3A4553	VW3A4553	VW3A31404	VW3A3600	
3	4	ATV320U30M3C	VW3A95815	VZ3V1302	TM200RSRCEMC	-	VW3A9525	-	VW3A7732	VW3A7604R07	VW3A7604R30	VW3A4553	VW3A4553	VW3A31406	VW3A3600	
4	5	ATV320U40M3C	VW3A95815	VZ3V1302	TM200RSRCEMC	-	VW3A9525	-	VW3A7733	VW3A7604R07	VW3A7604R30	VW3A4554	VW3A4554	VW3A31406	VW3A3600	
5.5	7.5	ATV320U55M3C	VW3A95816	VZ3V32C100	TM200RSRCEMC	-	VW3A9532	-	VW3A7733	-	-	VW3A4554	VW3A4554	VW3A31407	VW3A3600	
7.5	10	ATV320U75M3C	VW3A95816	VZ3V32C100	TM200RSRCEMC	-	VW3A9532	-	VW3A7734	-	-	VW3A4554	VW3A4554	VW3A31407	VW3A3600	
11	15	ATV320D11M3C	VW3A95818	VZ3V32D100	TM200RSRCEMC	-	VW3A9533	-	VW3A7735	-	-	VW3A4555	VW3A4556	VW3A31408	VW3A3600	
15	20	ATV320D15M3C	VW3A95818	VZ3V32D100	TM200RSRCEMC	-	VW3A9533	-	VW3A7736 (IP24)	-	-	VW3A4555	VW3A4556	VW3A31408	VW3A3600	
Drive with compact control block - three-phase supply voltage: 380...500 V 50/60 Hz																
0.37	0.5	ATV320U04N4C	VW3A95812	VZ3V1301	TM200RSRCEMC	VW3A9804	-	-	VW3A7730	VW3A7608R07	VW3A7608R30	VW3A4551	VW3A4552	VW3A31404	VW3A3600	
0.55	0.75	ATV320U06N4C	VW3A95812	VZ3V1301	TM200RSRCEMC	VW3A9804	-	-	VW3A7730	VW3A7608R07	VW3A7608R30	VW3A4551	VW3A4552	VW3A31404	VW3A3600	
0.75	1	ATV320U07N4C	VW3A95812	VZ3V1301	TM200RSRCEMC	VW3A9804	-	-	VW3A7730	VW3A7608R07	VW3A7608R30	VW3A4551	VW3A4552	VW3A31404	VW3A3600	
1.1	1.5	ATV320U11N4C	VW3A95812	VZ3V1301	TM200RSRCEMC	VW3A9804	-	-	VW3A7730	VW3A7608R07	VW3A7608R30	VW3A4551	VW3A4552	VW3A31404	VW3A3600	
1.5	2	ATV320U15N4C	VW3A95812	VZ3V1301	TM200RSRCEMC	VW3A9805	-	-	VW3A7730	VW3A7608R07	VW3A7608R30	VW3A4551	VW3A4552	VW3A31404	VW3A3600	
2.2	3	ATV320U22N4C	VW3A95814	VZ3V320S3	TM200RSRCEMC	VW3A9805	-	-	VW3A7730	VW3A7608R07	VW3A7608R30	VW3A4552	VW3A4552	VW3A31406	VW3A3600	
3	4	ATV320U30N4C	VW3A95814	VZ3V320S3	TM200RSRCEMC	VW3A9805	-	-	VW3A7730	VW3A7606R07	VW3A7606R30	VW3A4552	VW3A4552	VW3A31406	VW3A3600	
4	5	ATV320U40N4C	VW3A95814	VZ3V320S3	TM200RSRCEMC	VW3A9805	-	-	VW3A7731	VW3A7606R07	VW3A7606R30	VW3A4552	VW3A4552	VW3A31406	VW3A3600	
5.5	7.5	ATV320U55N4C	VW3A95816	VZ3V32C100	TM200RSRCEMC	-	VW3A9532	-	VW3A7731	VW3A7604R07	VW3A7604R30	VW3A4553	VW3A4553	VW3A4424	VW3A3600	
7.5	10.0	ATV320U75N4C	VW3A95816	VZ3V32C100	TM200RSRCEMC	-	VW3A9532	-	VW3A7732	VW3A7604R07	VW3A7604R30	VW3A4553	VW3A4554	VW3A4424	VW3A3600	
11.0	15.0	ATV320D11N4C	VW3A95816	VZ3V32D100	TM200RSRCEMC	-	VW3A9533	-	VW3A7732	-	-	VW3A4554	VW3A4554	VW3A4425	VW3A3600	
15.0	20.0	ATV320D15N4C	VW3A95816	VZ3V32D100	TM200RSRCEMC	-	VW3A9533	-	VW3A7733	-	-	VW3A4554	VW3A4555	VW3A4425	VW3A3600	
Drive with compact control block - three-phase supply voltage: 525...600 V 50/60 Hz																
0.75	1	ATV320U07S6C	VW3A95812	VZ3V1301	TM200RSRCEMC	VW3A9805	VW3A9524	-	VW3A7730	VW3A7608R07	VW3A7608R30	VW3A4551	VW3A4552	-	VW3A3600	
1.5	2	ATV320U15S6C	VW3A95812	VZ3V1301	TM200RSRCEMC	VW3A9805	VW3A9524	-	VW3A7730	VW3A7608R07	VW3A7608R30	VW3A4551	VW3A4552	-	VW3A3600	
2.2	3	ATV320U22S6C	VW3A95814	VZ3V320S3	TM200RSRCEMC	-	VW3A9525	-	VW3A7730	VW3A7608R07	VW3A7608R30	VW3A4551	VW3A4552	-	VW3A3600	
4	5	ATV320U40S6C	VW3A95814	VZ3V320S3	TM200RSRCEMC	-	VW3A9525	-	VW3A7730	VW3A7606R07	VW3A7606R30	VW3A4552	VW3A4552	-	VW3A3600	
5.5	7.5	ATV320U55S6C	VW3A95816	VZ3V32C100	TM200RSRCEMC	-	VW3A9532	-	VW3A7731	VW3A7604R07	VW3A7604R30	VW3A4553	VW3A4552	-	VW3A3600	
7.5	10	ATV320U75S6C	VW3A95816	VZ3V32C100	TM200RSRCEMC	-	VW3A9532	-	VW3A7732	VW3A7604R07	VW3A7604R30	VW3A4553	VW3A4553	-	VW3A3600	
11	15	ATV320D11S6C	VW3A95818	VZ3V32D100	TM200RSRCEMC	-	VW3A9533	-	VW3A7732	-	-	VW3A4554	VW3A4554	-	VW3A3600	
15	20	ATV320D15S6C	VW3A95818	VZ3V32D100	TM200RSRCEMC	-	VW3A9533	-	VW3A7732	-	-	VW3A4554	VW3A4554	-	VW3A3600	

Variable speed drives

Altivar Machine ATV320

Combinations of options for Altivar 320 drives, IP66/
IP65, compact format

Combinations of options for Altivar 320 drives

Motor		Drive	Accessories					Options						
kW	HP		UL Type 1 conformity kits	Fan for variable speed drive	Shielding connection clamps	DIN rail kit	EMC conformity kits	Braking resistors			Line chokes	Motor chokes	Additional EMC filters	Communication adapter card
							IP20	IP65 - 0.75 m/ 29.53 in. cable	IP65 - 3 m/ 118.11 in. cable					
Drive with compact control block - single-phase supply voltage: 200...240 V 50/60 Hz, IP66 without Vario														
0.18	0.25	ATV320U02M2W	–	–	TM200RSRCEMC	–	VW3A9535	VW3A7730	VW3A7608R07	VW3A7608R30	–	VW3A4552	VW3A31401	VW3A3600
0.37	0.5	ATV320U04M2W	–	–	TM200RSRCEMC	–	VW3A9535	VW3A7730	VW3A7608R07	VW3A7608R30	–	VW3A4552	VW3A31401	VW3A3600
0.55	0.75	ATV320U06M2W	–	–	TM200RSRCEMC	–	VW3A9535	VW3A7731	VW3A7608R07	VW3A7608R30	VZ1L007UM50	VW3A4552	VW3A31401	VW3A3600
0.75	1	ATV320U07M2W	–	–	TM200RSRCEMC	–	VW3A9535	VW3A7731	VW3A7608R07	VW3A7608R30	VZ1L007UM50	VW3A4552	VW3A31401	VW3A3600
1.1	1.5	ATV320U11M2W	–	VZ3V32066S2	TM200RSRCEMC	–	VW3A9535	VW3A7731	VW3A7605R07	VW3A7605R30	VZ1L018UM20	VW3A4552	VW3A31403	VW3A3600
1.5	2	ATV320U15M2W	–	VZ3V32066S2	TM200RSRCEMC	–	VW3A9535	VW3A7731	VW3A7605R07	VW3A7605R30	VZ1L018UM20	VW3A4552	VW3A31403	VW3A3600
2.2	3	ATV320U22M2W	–	VZ3V32066S2	TM200RSRCEMC	–	VW3A9535	VW3A7732	VW3A7603R07	VW3A7603R30	VZ1L018UM20	VW3A4553	VW3A31405	VW3A3600
Drive with compact control block - single-phase supply voltage: 200...240 V 50/60 Hz, IP66 with Vario														
0.18	0.25	ATV320U02M2WS	–	–	TM200RSRCEMC	–	VW3A9535	VW3A7730	VW3A7608R07	VW3A7608R30	–	VW3A4552	VW3A31401	VW3A3600
0.37	0.5	ATV320U04M2WS	–	–	TM200RSRCEMC	–	VW3A9535	VW3A7730	VW3A7608R07	VW3A7608R30	–	VW3A4552	VW3A31401	VW3A3600
0.55	0.75	ATV320U06M2WS	–	–	TM200RSRCEMC	–	VW3A9535	VW3A7731	VW3A7608R07	VW3A7608R30	VZ1L007UM50	VW3A4552	VW3A31401	VW3A3600
0.75	1	ATV320U07M2WS	–	–	TM200RSRCEMC	–	VW3A9535	VW3A7731	VW3A7608R07	VW3A7608R30	VZ1L007UM50	VW3A4552	VW3A31401	VW3A3600
1.1	1.5	ATV320U11M2WS	–	VZ3V32066S2	TM200RSRCEMC	–	VW3A9535	VW3A7731	VW3A7605R07	VW3A7605R30	VZ1L018UM20	VW3A4552	VW3A31403	VW3A3600
1.5	2	ATV320U15M2WS	–	VZ3V32066S2	TM200RSRCEMC	–	VW3A9535	VW3A7731	VW3A7605R07	VW3A7605R30	VZ1L018UM20	VW3A4552	VW3A31403	VW3A3600
2.2	3	ATV320U22M2WS	–	VZ3V32066S2	TM200RSRCEMC	–	VW3A9535	VW3A7732	VW3A7603R07	VW3A7603R30	VZ1L018UM20	VW3A4553	VW3A31405	VW3A3600
Drive with compact control block - three-phase supply voltage: 380...500 V 50/60 Hz, IP66 without Vario														
0.37	0.5	ATV320U04N4W	–	VZ3V32066S2	TM200RSRCEMC	–	VW3A9535	VW3A7730	VW3A7608R07	VW3A7608R30	VW3A4551	VW3A4552	VW3A31404	VW3A3600
0.55	0.75	ATV320U06N4W	–	VZ3V32066S2	TM200RSRCEMC	–	VW3A9535	VW3A7730	VW3A7608R07	VW3A7608R30	VW3A4551	VW3A4552	VW3A31404	VW3A3600
0.75	1	ATV320U07N4W	–	VZ3V32066S2	TM200RSRCEMC	–	VW3A9535	VW3A7730	VW3A7608R07	VW3A7608R30	VW3A4551	VW3A4552	VW3A31404	VW3A3600
1.1	1.5	ATV320U11N4W	–	VZ3V32066S2	TM200RSRCEMC	–	VW3A9535	VW3A7730	VW3A7608R07	VW3A7608R30	VW3A4551	VW3A4552	VW3A31404	VW3A3600
1.5	2	ATV320U15N4W	–	VZ3V32066S2	TM200RSRCEMC	–	VW3A9535	VW3A7730	VW3A7608R07	VW3A7608R30	VW3A4551	VW3A4552	VW3A31404	VW3A3600
2.2	3	ATV320U22N4W	–	VZ3V32066S3	TM200RSRCEMC	–	VW3A9535	VW3A7730	VW3A7608R07	VW3A7608R30	VW3A4552	VW3A4552	VW3A31406	VW3A3600
3	4	ATV320U30N4W	–	VZ3V32066S3	TM200RSRCEMC	–	VW3A9535	VW3A7730	VW3A7606R07	VW3A7606R30	VW3A4552	VW3A4552	VW3A31406	VW3A3600
4	5	ATV320U40N4W	–	VZ3V32066S3	TM200RSRCEMC	–	VW3A9535	VW3A7731	VW3A7606R07	VW3A7606R30	VW3A4552	VW3A4552	VW3A31406	VW3A3600
5.5	7.5	ATV320U55N4W	–	VZ3V32066S4	TM200RSRCEMC	–	VW3A9536	VW3A7731	VW3A7604R07	VW3A7604R30	VW3A4553	VW3A4553	VW3A4424	VW3A3600
7.5	10	ATV320U75N4W	–	VZ3V32066S4	TM200RSRCEMC	–	VW3A9536	VW3A7732	VW3A7604R07	VW3A7604R30	VW3A4553	VW3A4554	VW3A4424	VW3A3600
Drive with compact control block - three-phase supply voltage: 380...500 V 50/60 Hz, IP66 without Vario														
0.37	0.5	ATV320U04N4WS	–	VZ3V32066S2	TM200RSRCEMC	–	VW3A9535	VW3A7730	VW3A7608R07	VW3A7608R30	VW3A4551	VW3A4552	VW3A31404	VW3A3600
0.55	0.75	ATV320U06N4WS	–	VZ3V32066S2	TM200RSRCEMC	–	VW3A9535	VW3A7730	VW3A7608R07	VW3A7608R30	VW3A4551	VW3A4552	VW3A31404	VW3A3600
0.75	1	ATV320U07N4WS	–	VZ3V32066S2	TM200RSRCEMC	–	VW3A9535	VW3A7730	VW3A7608R07	VW3A7608R30	VW3A4551	VW3A4552	VW3A31404	VW3A3600
1.1	1.5	ATV320U11N4WS	–	VZ3V32066S2	TM200RSRCEMC	–	VW3A9535	VW3A7730	VW3A7608R07	VW3A7608R30	VW3A4551	VW3A4552	VW3A31404	VW3A3600
1.5	2	ATV320U15N4WS	–	VZ3V32066S2	TM200RSRCEMC	–	VW3A9535	VW3A7730	VW3A7608R07	VW3A7608R30	VW3A4551	VW3A4552	VW3A31404	VW3A3600
2.2	3	ATV320U22N4WS	–	VZ3V32066S3	TM200RSRCEMC	–	VW3A9535	VW3A7730	VW3A7608R07	VW3A7608R30	VW3A4552	VW3A4552	VW3A31406	VW3A3600
3	4	ATV320U30N4WS	–	VZ3V32066S3	TM200RSRCEMC	–	VW3A9535	VW3A7730	VW3A7606R07	VW3A7606R30	VW3A4552	VW3A4552	VW3A31406	VW3A3600
4	5	ATV320U40N4WS	–	VZ3V32066S3	TM200RSRCEMC	–	VW3A9535	VW3A7731	VW3A7606R07	VW3A7606R30	VW3A4552	VW3A4552	VW3A31406	VW3A3600
5.5	7.5	ATV320U55N4WS	–	VZ3V32066S4	TM200RSRCEMC	–	VW3A9536	VW3A7731	VW3A7604R07	VW3A7604R30	VW3A4553	VW3A4553	VW3A4424	VW3A3600
7.5	10	ATV320U75N4WS	–	VZ3V32066S4	TM200RSRCEMC	–	VW3A9536	VW3A7732	VW3A7604R07	VW3A7604R30	VW3A4553	VW3A4554	VW3A4424	VW3A3600

Variable speed drives

Altivar Machine ATV320

Combinations of options for Altivar 320 drives, IP20, book format

Option modules for ATV320 drives

Combinations of options for Altivar 320 drives													
Motor kW HP		Drive	Accessories					Options					
			UL Type 1 conformity kits	Fan for variable speed drive	Shielding connection clamps	Bracket for GV2 direct mounting	DC bus connector kit	Braking resistors			Line chokes	Motor chokes	Additional EMC filters
			IP20	IP65 - 0.75 m/ 29.53 in. cable	IP65 - 3 m/ 118.11 in. cable								

Drive with book control block - single-phase supply voltage: 200...240 V 50/60 Hz														
0.18	0.25	ATV320U02M2B	–	VZ3V32A100	TM200RSRCEMC	VW3A9921	VW3M2207	VW3A7730	VW3A7608R07	VW3A7608R30	–	VW3A4552	VW3A4420	–
0.37	0.5	ATV320U04M2B	–	VZ3V32A100	TM200RSRCEMC	VW3A9921	VW3M2207	VW3A7730	VW3A7608R07	VW3A7608R30	–	VW3A4552	VW3A4420	–
0.55	0.75	ATV320U06M2B	–	VZ3V32A100	TM200RSRCEMC	VW3A9921	VW3M2207	VW3A7731	VW3A7608R07	VW3A7608R30	VZ1L007UM50	VW3A4552	VW3A4420	–
0.75	1	ATV320U07M2B	–	VZ3V32A100	TM200RSRCEMC	VW3A9921	VW3M2207	VW3A7731	VW3A7608R07	VW3A7608R30	VZ1L007UM50	VW3A4552	VW3A4420	–
1.1	1.5	ATV320U11M2B	–	VZ3V32B100	TM200RSRCEMC	VW3A9921	VW3M2207	VW3A7731	VW3A7605R07	VW3A7605R30	VZ1L018UM20	VW3A4552	VW3A4421	–
1.5	2	ATV320U15M2B	–	VZ3V32B100	TM200RSRCEMC	VW3A9921	VW3M2207	VW3A7731	VW3A7605R07	VW3A7605R30	VZ1L018UM20	VW3A4552	VW3A4421	–
2.2	3	ATV320U22M2B	–	VZ3V32B100	TM200RSRCEMC	VW3A9921	VW3M2207	VW3A7732	VW3A7603R07	VW3A7603R30	VZ1L018UM20	VW3A4553	VW3A4426	–

Drive with book control block - three-phase supply voltage: 380...500 V 50/60 Hz														
0.37	0.5	ATV320U04N4B	–	VZ3V32A100	TM200RSRCEMC	VW3A9921	VW3M2207	VW3A7730	VW3A7608R07	VW3A7608R30	VW3A4551	VW3A4552	VW3A4422	–
0.55	0.75	ATV320U06N4B	–	VZ3V32A100	TM200RSRCEMC	VW3A9921	VW3M2207	VW3A7730	VW3A7608R07	VW3A7608R30	VW3A4551	VW3A4552	VW3A4422	–
0.75	1	ATV320U07N4B	–	VZ3V32A100	TM200RSRCEMC	VW3A9921	VW3M2207	VW3A7730	VW3A7608R07	VW3A7608R30	VW3A4551	VW3A4552	VW3A4422	–
1.1	1.5	ATV320U11N4B	–	VZ3V32A100	TM200RSRCEMC	VW3A9921	VW3M2207	VW3A7730	VW3A7608R07	VW3A7608R30	VW3A4551	VW3A4552	VW3A4422	–
1.5	2	ATV320U15N4B	–	VZ3V32A100	TM200RSRCEMC	VW3A9921	VW3M2207	VW3A7730	VW3A7608R07	VW3A7608R30	VW3A4551	VW3A4552	VW3A4422	–
2.2	3	ATV320U22N4B	–	VZ3V32B100	TM200RSRCEMC	VW3A9921	VW3M2207	VW3A7730	VW3A7608R07	VW3A7608R30	VW3A4552	VW3A4552	VW3A4422	–
3	4	ATV320U30N4B	–	VZ3V32B100	TM200RSRCEMC	VW3A9921	VW3M2207	VW3A7730	VW3A7606R07	VW3A7606R30	VW3A4552	VW3A4552	VW3A4422	–
4	5	ATV320U40N4B	–	VZ3V32B100	TM200RSRCEMC	VW3A9921	VW3M2207	VW3A7731	VW3A7606R07	VW3A7606R30	VW3A4552	VW3A4552	VW3A4422	–
5.5	7.5	ATV320U55N4B	VW3A95817	VZ3V32C100	TM200RSRCEMC	–	–	VW3A7731	VW3A7604R07	VW3A7604R30	VW3A4553	VW3A4553	VW3A4424	–
7.5	10	ATV320U75N4B	VW3A95817	VZ3V32C100	TM200RSRCEMC	–	–	VW3A7732	VW3A7604R07	VW3A7604R30	VW3A4553	VW3A4554	VW3A4424	–
11	15	ATV320D11N4B	VW3A95819	VZ3V32D100	TM200RSRCEMC	–	–	VW3A7732	–	–	VW3A4554	VW3A4554	VW3A4425	–
15	20	ATV320D15N4B	VW3A95819	VZ3V32D100	TM200RSRCEMC	–	–	VW3A7733	–	–	VW3A4554	VW3A4555	VW3A4425	–

Option modules (1) (2)		
Description	Reference	Page
Communication option modules		
CANopen Daisy Chain 2 x RJ45 communication module	VW3A3608	38
CANopen SUB-D9 communication module	VW3A3618	38
CANopen open style communication module	VW3A3628	39
Ethernet TCP/IP communication module	VW3A3616	40
EtherCAT 2 x RJ45 communication module	VW3A3601	41
Profibus DP communication module	VW3A3607	41
DeviceNet communication module	VW3A3609	41
POWERLINK communication module	VW3A3619	41
ProfiNet communication module	VW3A3627	41
Other option modules		
Speed monitoring card - RS422 - 5V	VW3A3620	35

(1) To use with ATV320 drives with a compact control block, the option module adapter is required (to be ordered separately).
 (2) Only one module can be connected at once.

Minimum value of the resistor to be connected					
Catalog Number	Minimum Value in Ω	Catalog Number	Minimum Value in Ω	Catalog Number	Minimum Value in Ω
ATV320U02M●●	40	ATV320D11M3C	5	ATV320U07N4●	80
ATV320U04M●●	40	ATV320D15M3C	5	ATV320D11N4●	16
ATV320U06M●●	40	ATV320U11N4●	54	ATV320D15N4●	16
ATV320U07M●●	40	ATV320U15N4●	54	ATV320U07S6C	96
ATV320U11M●●	27	ATV320U22N4●	54	ATV320U15S6C	64
ATV320U15M●●	27	ATV320U30N4●	54	ATV320U22S6C	64
ATV320U22M●●	25	ATV320U40N4●	36	ATV320U40S6C	44
ATV320U30M3C	16	ATV320U55N4●	27	ATV320U55S6C	27
ATV320U40M3C	16	ATV320U75N4●	27	ATV320U75S6C	23
ATV320U55M3C	8	ATV320U04N4●	80	ATV320D11S6C	24
ATV320U75M3C	8	ATV320U06N4●	80	ATV320D15S6C	24

PF108005

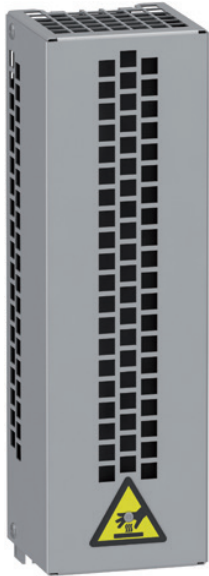

VW3A7731

Presentation

Braking resistors allow Altivar Machine ATV320 drives to operate while braking to a standstill or during slowdown braking, by dissipating the braking energy. They enable maximum transient braking torque. Depending on the drive rating, the following types of resistor are available:

- Enclosed model (IP 20 casing) designed to comply with the EMC standard and protected by a temperature-controlled switch
- Enclosed model (IP 65 casing) with cordset

Note: To optimize the size of the braking resistor, the DC buses on Altivar Machine ATV320 drives in the same application can be connected in parallel (see [page 18](#)).

Applications

Machines with high inertia, driving loads, and machines with fast cycles.

References

For drives	Ohmic value	Average power available at 50 °C/122 °F (1)	Length of connection cable	Reference (2)	Weight
	Ω	W	m/ft		kg/lb
IP 20 resistors					
ATV320U02M●● ATV320U04M●● ATV320U04N4●...U30N4● ATV320U07S6C...U40S6C	100	100	–	VW3A7730	1.500/3.307
ATV320U06M●●...U15M●● ATV320U40N4● ATV320U55N4● ATV320U55S6C	60	160	–	VW3A7731	1.800/3.968
ATV320U22M● ATV320U30M3C ATV320U75N4● ATV320D11N4● ATV320U75S6C...D15S6C	28	300	–	VW3A7732	2.700/5.952
ATV320U40M3C ATV320U55M3C ATV320D15N4●	16	960	–	VW3A7733	3.800/8.377
ATV320U75M3C	10	960	–	VW3A7734	4.300/9.480
ATV320D11M3C	8	960	–	VW3A7735	4.500/9.920
ATV320D15M3C	5	1900	–	VW3A7736	18.000/39.683

(1) Load factor for resistors: the value of the average power that can be dissipated at 50 °C/122 °F from the resistor into the casing is determined for a load factor during braking that corresponds to the majority of normal applications:

- 2 s braking with a 0.6 T_n braking torque for a 40 s cycle
- 0.8 s braking with a 1.5 T_n braking torque for a 40 s cycle

(2) Recommended braking resistors when ATV320 is used with synchronous motor.



References (continued)					
For drives	Ohmic value	Average power available at 50 °C/122 °F (1)	Length of connection cable	Reference (2)	Weight
	Ω	W	m/ft		kg/lb
IP 65 resistors					
ATV320U02M2●...U07M2● ATV320U04N4●...U22N4● ATV320U02M3C...U07M3C ATV320U07S6C...U22S6C	100	25	0.75/ 2.46 3.0/ 9.84	VW3A7608R07 VW3A7608R30	0.410/0.904 0.760/1.675
ATV320U30N4●...U40N4● ATV320U40S6C	72	50	0.75/ 2.46 3.0/ 9.84	VW3A7606R07 VW3A7606R30	0.930/2.050 1.200/2.645
ATV320U11M2● ATV320U11M3C ATV320U15M3C	72	25	0.75/ 2.46 3.0/ 9.84	VW3A7605R07 VW3A7605R30	0.620/1.367 0.850/1.874
ATV320U55N4● ATV320U75N4● ATV320U55S6C ATV320U75S6C	27	100	0.75/ 2.46 3.0/ 9.84	VW3A7604R07 VW3A7604R30	1.420/3.131 1.620/3.571
ATV320U22M2● ATV320U22M3C	27	50	0.75/ 2.46 3.0/ 9.84	VW3A7603R07 VW3A7603R30	0.930/2.050 1.200/2.645

(1) Load factor for resistors: the value of the average power that can be dissipated at 50 °C/122 °F from the resistor into the casing is determined for a load factor during braking that corresponds to the majority of normal applications:- 2 s braking with a 0.6 T_n braking torque for a 40 s cycle- 0.8 s braking with a 1.5 T_n braking torque for a 40 s cycle.

(2) Recommended braking resistors when ATV320 is used with synchronous motor.

Nota: no optional IP65 braking resistors for ATV320U55S6C, ATV320U75S6C, ATV320D11S6C, ATV320D15S6C, and ATV320●●●M3C drives.

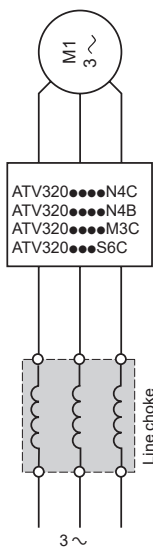
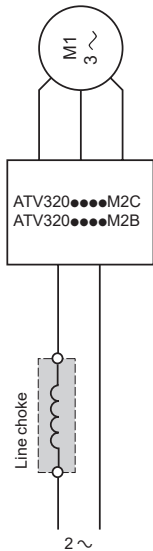

Presentation

Line chokes

Line chokes, also known as line reactors, provide improved immunity against overvoltages on the supply mains and can reduce harmonic distortion of the current produced by the drive.

The recommended chokes limit the line current. They have been developed in line with standard IEC 61800-5-1 (VDE 0160 level 1 high-energy overvoltages on the line supply).

The inductance values are defined for a voltage drop between 3% and 5% of the nominal line voltage. Values higher than this will cause loss of torque.

The use of line chokes is recommended in particular under the following circumstances:

- Supply mains with significant disturbance from other equipment (interference, overvoltages)
 - Supply mains with voltage imbalance between phases > 1.8% of nominal voltage
 - Drive supplied by a supply mains with very low impedance (in the vicinity of a power transformer 10 times more powerful than the drive rating)
 - Installation of a large number of frequency inverters on the same supply mains
 - Reduction of overloads on the cos φ correction capacitors, if the installation includes a power factor correction unit
- The prospective short-circuit current at the point of connection of the drive must not exceed the maximum value indicated in the reference tables (see [page 16](#)). The use of chokes allows connection to the following supply mains:
- Max. Isc 22 kA for 200/240 V
 - Max. Isc 65 kA for 380/500 V

References

Drive Reference	Line current, without choke		Line current, with choke		Choke Reference	Weight kg/lb
	U min. (1)	U max. (1)	U min. (1)	U max. (1)		
Single-phase supply voltage: 200...240 V 50/60 Hz						
ATV320U06M2●	7.9	6.7	5.8	5.0	VZ1L007UM50	0.880/1.940
ATV320U07M2●	10.1	8.5	7.5	6.4		
ATV320U11M2●	13.6	11.5	11.0	9.4	VZ1L018UM20	1.990/4.387
ATV320U15M2●	17.6	14.8	14.3	12.2		
ATV320U22M2●	23.9	20.1	19.9	16.8		
Three-phase supply voltage: 200...240 V 50/60 Hz						
ATV320U02M3C	2.0	1.7	1.0	0.9	VW3A4551	1.500/3.307
ATV320U04M3C	3.6	3.0	1.9	1.6		
ATV320U06M3C	4.9	4.2	2.7	2.3		
ATV320U07M3C	6.3	5.3	3.6	3.0		
ATV320U11M3C	8.6	7.2	5.0	4.2	VW3A4552	3.000/6.613
ATV320U15M3C	11.1	9.3	6.7	5.6		
ATV320U22M3C	14.9	12.5	9.4	7.9	VW3A4553	3.500/7.716
ATV320U30M3C	18.7	15.7	12.5	10.4		
ATV320U40M3C	23.8	19.9	16.3	13.8	VW3A4554	6.000/13.228
ATV320U55M3C	35.4	29.8	21.8	18.2		
ATV320U75M3C	45.3	38.2	29.1	24.2		
ATV320D11M3C	60.9	51.4	41.1	34.4	VW3A4555	11.000/24.251
ATV320D15M3C	79.7	67.1	54.7	45.6		
Three-phase supply voltage: 380...500 V 50/60 Hz						
ATV320U04N4●	2.1	1.6	1.1	0.9	VW3A4551	1.500/3.307
ATV320U06N4●	2.8	2.2	1.5	1.3		
ATV320U07N4●	3.6	2.7	1.9	1.6		
ATV320U11N4●	5.0	3.8	2.7	2.1		
ATV320U15N4●	6.5	4.9	3.5	2.7		
ATV320U22N4●	8.7	6.6	5.1	4.0	VW3A4552	3.000/6.613
ATV320U30N4●	11.1	8.4	6.6	5.2		
ATV320U40N4●	13.7	10.5	8.5	6.6		
ATV320U55N4●	20.7	14.5	11.5	9.3	VW3A4553	3.500/7.716
ATV320U75N4●	26.5	18.7	15.3	12.0		
ATV320D11N4●	36.6	25.6	21.8	17.8	VW3A4554	6.000/13.228
ATV320D15N4●	47.3	33.3	28.8	22.8		
Three-phase supply voltage: 525...600 V 50/60 Hz (2)						
ATV320U07S6C	–	–	1.5	1.4	VW3A4551	1.500/3.307
ATV320U15S6C	–	–	2.6	2.4		
ATV320U22S6C	–	–	3.7	3.2		
ATV320U40S6C	–	–	6.5	5.8	VW3A4552	3.000/6.613
ATV320U55S6C	–	–	8.4	7.5		3.500/7.716
ATV320D11S6C	–	–	15.8	14.1	VW3A4553	6.000/13.228
ATV320U75S6C	–	–	11.6	10.5		3.500/7.716
ATV320D15S6C	–	–	22.1	20.1	VW3A4554	6.000/13.228

(1) Nominal supply voltage

(2) ATV320●●●S6C drives must not be used without a Line choke

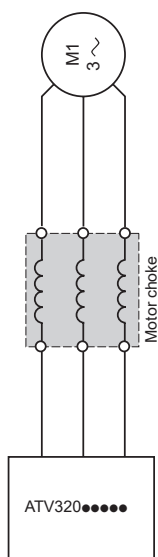

Presentation

Motor chokes

Motor chokes, also known as load reactors, can be inserted between the Altivar Machine ATV320 drive and the motor to:

- Limit the dv/dt at the motor terminals (500 to 1500 V/μs), for cables longer than 50 m/164.04 ft
- Filter interference caused by the opening of a contactor placed between the filter and the motor
- Reduce the motor ground leakage current
- Smooth the motor current wave form to reduce motor noise

References

For drives	Losses W	Cable length (1)		Nominal current A	Reference	Weight kg/lb
		Shielded cable m/ft	Unshielded cable m/ft			
Single-phase supply voltage: 200...240 V 50/60 Hz						
ATV320U02M2●...U15M2●	65	≤ 100/328.08	≤ 200/656.17	10	VW3A4552	3.000/6.613
ATV320U22M2●	75	≤ 100/328.08	≤ 200/656.17	16	VW3A4553	3.500/7.716
Three-phase supply voltage: 200...240 V 50/60 Hz						
ATV320U02M3C...U15M3C	65	≤ 100/328.08	≤ 200/656.17	10	VW3A4552	3.000/6.613
ATV320U22M3C ATV320U30M3C	75	≤ 100/328.08	≤ 200/656.17	16	VW3A4553	3.500/7.716
ATV320U40M3C...U75M3C	90	≤ 100/328.08	≤ 200/656.17	30	VW3A4554	6.000/13.228
ATV320D11M3C...D15M3C	260	≤ 100/328.08	≤ 200/656.17	107	VW3A4556	16.000/35.274
Three-phase supply voltage: 380...500 V 50/60 Hz						
ATV320U04N4●...U40N4●	65	≤ 100/328.08	≤ 200/656.17	10	VW3A4552	3.000/6.613
ATV320U55N4●	75	≤ 100/328.08	≤ 200/656.17	16	VW3A4553	3.500/7.716
ATV320U75N4● ATV320D11N4●	90	≤ 100/328.08	≤ 200/656.17	30	VW3A4554	6.000/13.228
ATV320D15N4●	80	≤ 100/328.08	≤ 200/656.17	60	VW3A4555	11.000/24.251
Three-phase supply voltage: 525...600 V 50/60 Hz						
ATV320U07S6C ATV320U15S6C ATV320U22S6C ATV320U40S6C ATV320U55S6C	65	≤ 100/328.08	≤ 200/656.17	10	VW3A4552	3.000/6.613
ATV320U75S6C	75	≤ 100/328.08	≤ 200/656.17	16	VW3A4553	3.500/7.716
ATV320D11S6C ATV320D15S6C	75	≤ 100/328.08	≤ 200/656.17	16	VW3A4554	6.000/13.228

(1) For an application with several motors connected in parallel, the total motor cable lengths must be added together. If a cable longer than that recommended is used, the filters may overheat.

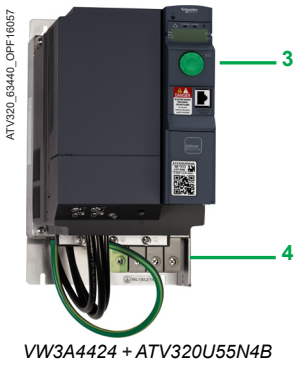
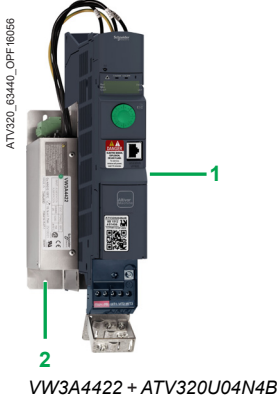

Presentation

Additional EMC Filter

The additional EMC input filters enable the drives to meet more stringent requirements;

- They are designed to reduce conducted emissions on the supply mains below the limits of standard IEC 61800-3 category C1 or C2.
- Enlarge the maximum motor cable length of IEC 61800-3 category C3

Mounting on ATV320●●●●B

- Depending on the model, additional EMC filters can be mounted beside or underneath the drive.
- They act as a support for the drives and are attached to them via tapped holes.

Mounting the filter on the side of the drive:

- 1 ATV320●●●M2B, ATV320U04N4B...U40N4B drives
- 2 Additional EMC input filters

Mounting the filter underneath the drive:

- 3 ATV320U55N4B...U75N4B and ATV320D11N4B...D15N4B drives
- 4 Additional EMC input filters

Mounting on ATV320●●●●C

Additional EMC filters can be mounted beside or underneath the ATV320●●●●C drives, except for the ATV320●●●S6C drives.

They act as a support for the drives and are attached to them via tapped holes.

Use according to the type of supply mains

- Additional EMC filters can only be used on TN (neutral connection) and TT (grounded neutral) type systems.
- Standard IEC 61800-3, appendix D2.1, states that on IT systems (isolated or impedance grounded neutral), filters can cause permanent insulation monitors to operate in a random manner.
- The effectiveness of additional filters on this type of system depends on the type of impedance between neutral and ground, and therefore cannot be predicted.
- If a machine has to be installed on an IT system, one solution is to insert an isolation transformer and connect the machine locally on a TN or TT system.
- The radio interference input filters integrated in Altivar 320 drives can easily be disconnected by means of a selector switch without removing the drive.

References								
Additional EMC input filters								
For drives	Additional EMC input filter							
Reference	Maximum length of shielded cable (1) In (2)	In (3)	Losses (4)	Mounting the filter/ Book format	Reference	Weight		
IEC 61800-3 (5)								
Category C3 Category C2 Category C1								
		m/ft	m/ft	m/ft	A	W	kg/lb	
Single-phase supply voltage: 200...240 V 50/60 Hz								
ATV320U02M2C...U07M2C ATV320U02M2W...U07M2W ATV320U02M2WS...U07M2WS	100/328.08	50/164.04	20/65.61	9	3.7	–	VW3A31401	0.600/ 1.323
ATV320U11M2C...U15M2C ATV320U11M2W...U15M2W ATV320U11M2WS...U15M2WS	100/328.08	50/164.04	20/65.61	16	6.9	–	VW3A31403	0.775/ 1.709
ATV320U22M2C ATV320U22M2W ATV320U22M2WS	100/328.08	50/164.04	20/65.61	22	7.5	–	VW3A31405	1.130/ 2.491
ATV320U02M2B...U07M2B	50/164.04	20/65.61	5/16.40	10.1	3.7	On the side	VW3A4420	0.600/ 1.323
ATV320U11M2B...U15M2B	100/328.08	50/164.04	2/65.61	17.6	6.9	On the side	VW3A4421	0.775/ 1.709
ATV320U22M2B	100/328.08	50/164.04	2/65.61	23.9	7.5	On the side	VW3A4426	1.130/ 2.491
Three-phase supply voltage: 200...240 V 50/60 Hz								
ATV320U02M3C...U07M3C	5/16.40	5/16.40	1/3.28	7	2.6	–	VW3A31402	0.650/ 1.433
ATV320U11M3C...U22M3C	5/16.40	5/16.40	1/3.28	15	9.9	–	VW3A31404	1.000/ 2.205
ATV320U30M3C...U40M3C	5/16.40	5/16.40	1/3.28	25	15.8	–	VW3A31406	1.650/ 3.637
ATV320U55M3C...U75M3C	5/16.40	5/16.40	1/3.28	47	19.3	–	VW3A31407	3.150/ 6.945
ATV320D11M3C...D15M3C	5/16.40	5/16.40	1/3.28	83	35.2	–	VW3A31408	5.300/ 11.684
Three-phase supply voltage: 380...500 V 50/60 Hz								
ATV320U04N4C...U15N4C ATV320U04N4W...U15N4W ATV320U04N4WS...U15N4WS	150/492.12	50/164.04	20/65.61	15	9.9	–	VW3A31404	1.000/ 2.205
ATV320U22N4C...U40N4C ATV320U22N4W...U40N4W ATV320U22N4WS...U40N4WS	100/328.08	50/164.04	20/65.61	25	15.8	–	VW3A31406	1.650/ 3.637
ATV320U04N4B...U40N4B	150/492.12	50/164.04	20/65.61	15	9.9	On the side	VW3A4422	0.900/ 1.984
ATV320U55N4...U75N4 ATV320U55N4W...U75N4W ATV320U55N4WS...U75WS	150/492.12	100/328.08	20/65.61	47	19.3	Underneath	VW3A4424	3.150/ 6.944
ATV320U07N4B...ATV320U15N4B	150/492.12	100/328.08	20/65.61	6.5	N/A	Underneath	VW3A4461	–
ATV320U30N4B...ATV320U40N4B	150/492.12	100/328.08	20/65.61	13.7	N/A	Underneath	VW3A4462	–
ATV320D11N4B...D15N4B	150/492.12	100/328.08	20/65.61	49	27.4	Underneath	VW3A4425	4.750/ 10.472
ATV320D11N4C...D15N4C	150/492.12	100/328.08	5/16.40	49	27.4	Underneath	VW3A4425	4.750/ 10.472

(1) The filter selection tables give the maximum lengths for shielded cables connecting motors to drives. These maximum lengths are given as examples only, as they vary depending on the stray capacitance of the motors and the cables used. If motors are connected in parallel, it is the total length of all cables that should be taken into account.

(2) These values are given for a nominal switching frequency of 4 kHz.

(3) In: nominal filter current.

(4) Via heat dissipation, at the nominal filter current (In).

(5) Standard IEC 61800-3:

Environmental 1 (Residential): C1 and C2

EN55011 Group 1: Class B and Class A

Environmental 2 (Industrial): C3 and C4

EN55011 Group 2: Class A and N/A

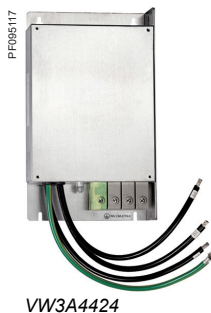
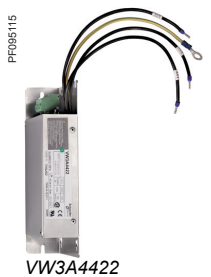



Example of installing a communication module 3
(view of underside) on a drive with compact control block

Presentation

Altivar Machine ATV320 drives are designed for use with option modules according to machine and application requirements; only one option module can be used with an Altivar Machine ATV320 at a time.

The option modules are compatible with all Altivar Machine ATV320 drives (see [page 32](#)).

The **VW3A3600** option module adapter is required to connect an option module to Altivar Machine ATV320 IP20 drives with a compact control block and ATV320 IP66/65 products. **ATV320●●●●●C** and ATV320 IP65/66 products **ATV320●●●●●W/ATV320●●●●●WS**.

Compact control block

An adapter should be added to the Altivar Machine ATV320 drives with compact control block in order to connect communication and speed monitoring modules.

- 1 Communication adapter card
- 2 Slot for the communication or speed monitoring module
- 3 Communication module

References

Description	Reference	Weight kg/lb
Communication adapter card for ATV320 with compact control block	VW3A3600	—

Book control block

Altivar Machine ATV320 drives with a book control block have been designed to simplify connections to communication buses and networks by means of the following:

- 4 Integrated RJ45 communication port for Modbus/CANopen on the front
- 5 Slot for the communication module
- 6 Communication module

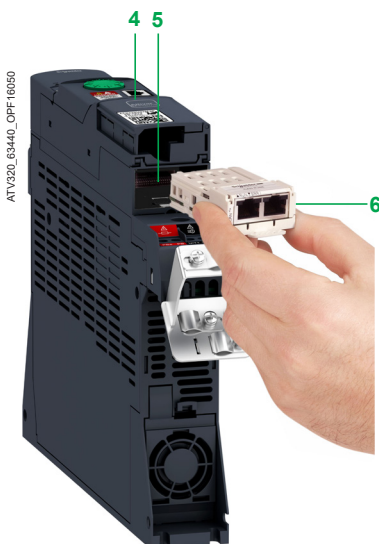

Example of installing a communication module 6
(view of underside) on a drive with book control block

PF130614

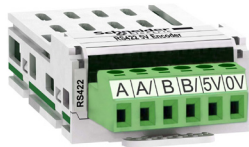

VW3A3620

Presentation

The VW3A3620 speed monitoring module is recommended for hoisting applications in OPEN loop control.

This module helps to detect undesired load slip on hoisting applications by means of an external encoder. The variable speed drive manages the load slip according to the configuration parameters.

Functions

- The load slip frequency threshold represents the difference between the speed feedback and the output frequency.
- The load slip detection level can be adjusted so that the function can be used more efficiently.
- The load slip direction check allows the variable speed drive to check that movement is initiated in the desired direction.
- The load slip detection duration can be configured in order to optimize the use of the function according to the changing mechanics.

The **VW3A3620** speed monitoring module helps to ensure that the actual motor speed is within the acceptable threshold settings and that movement is in the desired direction.

The variable speed drive will trigger a warning and the motor will stop either with a freewheel stop or via the brake logic control function (depending on the configuration) in the following cases:

- if the actual speed is different from the permitted speed reference threshold and this reaches the defined duration, or
- if the direction of motor rotation is not as expected

Speed monitoring module (1)

Description	Reference	Weight kg/lb
Speed monitoring module Port: One 6-way screw connector	VW3A3620	0.300/ 0.660
<ul style="list-style-type: none"> ■ RS422 ■ Input nominal voltage: 5 V 		

(1) To use with ATV320 drives with a compact control block, the option module adapter is required (to be ordered separately).

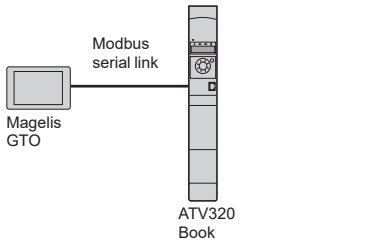

Example of configuration on Modbus serial link

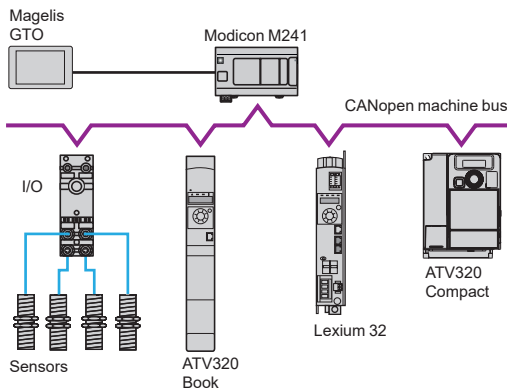

Example of configuration on CANopen machine bus

Presentation

Altivar Machine ATV320 drives are designed to meet the configuration requirements found in the main industrial communication installations.

The Modbus and CANopen communication protocols are integrated as standard and can be accessed directly via the RJ45 communication port located on the front of the book control block drive and underneath the front door of the compact control block drive.

ATV320 drives can also be connected to other industrial communication buses and networks by using one of the communication modules available as an option. Communication modules are supplied in “cassette” format for ease of mounting/removal.

Modbus serial link (1)

The Modbus serial link is used for connecting the following HMI and configuration tools:

- The Magelis HMI terminal
- Remote display terminal, remote graphic display terminal
- SoMove setup software, Simple Loader and Multi-loader configuration tools

CANopen machine bus (1) (2) (3)

The CANopen machine bus is used for integration into control system architectures, especially when combined with Modicon M241 and M251 logic controllers or Lexium 32 motion controllers.

Optimized solutions for connection to the CANopen machine bus

To simplify setting up the Altivar Machine ATV320 drive, 3 dedicated CANopen communication modules (2) are available depending on the connection and connector types:

- CANopen daisy chain module with 2 RJ45 connectors offering an optimized solution for daisy chain connection to the CANopen machine bus (see [page 48](#))
- CANopen module for connection to the bus via 9-way SUB-D connector (see [page 48](#))
- CANopen module for connection to the bus via terminals (see [page 49](#))

Using one of the CANopen communication modules also reduces the installation dimensions compared to using **VW3CANTAP2** and **TSXCANTDM4** junction boxes.

Communication modules for industrial applications (3)

The following communication modules are available:

- Modbus TCP and EtherNet/IP
- PROFIBUS DP V1
- DeviceNet
- EtherCAT
- POWERLINK
- PROFINET

Description

Altivar Machine ATV320 drives with book control block have been designed to simplify connections to communication buses and networks by means of the following:

- 1 Integrated RJ45 communication port for Modbus/CANopen on the front
- 2 Slot for the communication module
- 3 Communication module

Altivar Machine ATV320 drives with compact control block are equipped as standard with:

- 1 Integrated RJ45 communication port for Modbus/CANopen
- The **VW3A3600** mechanical adapter for communication modules can be used to make more communication buses and networks available by inserting the corresponding module directly into the adapter.
- 2 Slot for the communication module
- 3 Communication module

(1) The Modbus serial link always uses the RJ45 communication port. If simultaneous use of the Modbus serial link and the CANopen machine bus is required, a CANopen communication module is needed.

(2) When one of the CANopen communication modules is inserted in the Altivar 320 drive, CANopen communication via the RJ45 communication port is disabled.

(3) The Altivar 320 drive can only take one communication module.

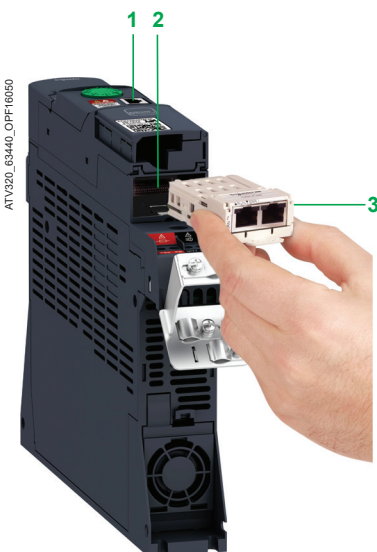

Example of installing a communication module 3 (view of underside)



Altivar 320 compact format drive with communication module in the option module adapter

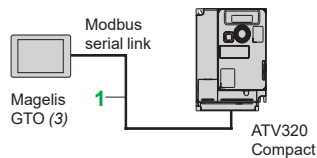

Example of connection of an Altivar 320 compact format drive and a Magelis GTO HMI terminal via the Modbus serial link

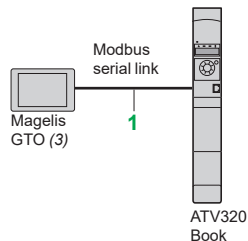

Example of connection of an Altivar 320 book format drive and a Magelis GTO HMI terminal via the Modbus serial link

Functions

All Altivar Machine ATV320 drive functions can be accessed via the communication buses and networks:

- Control
- Monitoring
- Adjustment
- Configuration

The speed reference and command may come from different sources:

- digital input or analog I/O terminals
- Communication bus or network
- Remote display terminals

The ATV320 drive's advanced functions can be used to manage switching of these drive control sources according to the application requirements.

The communication periodic I/O data assignment can be selected using the network configuration software.

The ATV320 drive can be controlled:

- According to the CiA 402 native profile
- According to the I/O profile

Communication is monitored according to criteria specific to each protocol.

Regardless of protocol type, the reaction of the drive to a detected communication interruption can be configured as follows:

- Freewheel stop, stop on ramp, fast stop, or braked stop
- Maintain the last command received
- Fallback position at a predefined speed
- Ignore the detected error

Modbus serial link (1)

Connection accessories for remote Human-Machine Interface (2)

Description	Item no.	Length m/ft	Reference	Weight kg/lb
Cordsets for Modbus serial link equipped with 2 RJ45 connectors	1	0.3/0.98	VW3A8306R03	0.025/ 0.055
		1.0/3.28	VW3A8306R10	0.060/ 0.132
		3.0/9.84	VW3A8306R30	0.130/ 0.287

(1) The Modbus serial link always uses the RJ45 communication port. If simultaneous use of the Modbus serial link and the CANopen machine bus is required, a CANopen communication module is needed.

(2) See page 28 for connection of a remote display terminal or remote graphic display terminal.

(3) Requires a 24 V $\bar{\text{v}}$ power supply. Please refer to the "Human/Machine interfaces" catalog.



VW3A3608

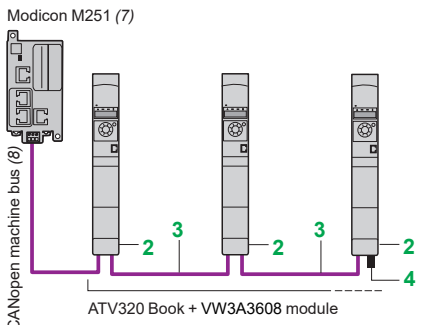
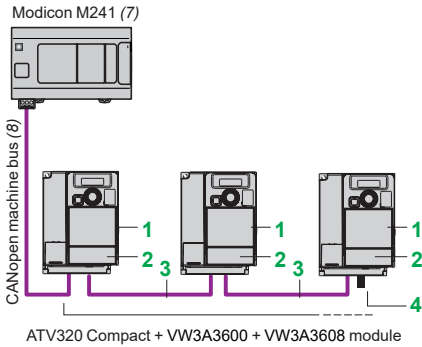

Optimized solution for daisy chain connection to the CANopen machine bus



VW3A3618

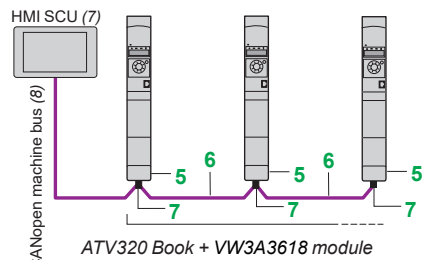

Example of connection to the CANopen machine bus via SUB-D connector

Compact drive communication adapter (1)

Description	Item no.	Length m/ft	Unit reference	Weight kg/lb
Communication module adapter for ATV320 Compact	1	–	VW3A3600	–

CANopen machine bus (2)

Description	Item no.	Length m/ft	Unit reference	Weight kg/lb
-------------	----------	-------------	----------------	--------------

Connection with VW3A3608 CANopen daisy chain module (optimized solution for daisy chain connection to the CANopen machine bus)

CANopen daisy chain communication module (2) (3) (4) Ports: 2 RJ45 connectors	2	–	VW3A3608	–
CANopen cordsets equipped with 2 RJ45 connectors	3	0.3/ 0.98	VW3CANCARR03	0.050/ 0.110
		1.0/ 3.28	VW3CANCARR1	0.500/ 1.102

CANopen line terminator for RJ45 connector	4	–	TCSCAR013M120	–
--	---	---	---------------	---

Connection via SUB-D connector with VWA3618 CANopen module

CANopen communication module (2) (3) Port: 1 x 9-way male SUB-D connector	5	–	VW3A3618	–
--	---	---	----------	---

CANopen cable Standard cable, CE marking Low smoke zero halogen Flame retardant (IEC 60332-1)	6	50/ 164.04	TSXCANCA50	4.930/ 10.869
		100/ 328.08	TSXCANCA100	8.800/ 19.401
		300/ 984.25	TSXCANCA300	24.560/ 54.145

CANopen cable Standard cable, UL certification, CE marking Flame retardant (IEC 60332-2)	6	50/ 164.04	TSXCANCB50	3.580/ 7.892
		100/ 328.08	TSXCANCB100	7.840/ 17.284
		300/ 984.25	TSXCANCB300	21.870/ 48.215

CANopen cable Cable for harsh environments (5) or mobile installations, CE marking Low smoke zero halogen Flame retardant (IEC 60332-1)	6	50/ 164.04	TSXCANCD50	3.510/ 7.738
		100/ 328.08	TSXCANCD100	7.770/ 17.130
		300/ 984.25	TSXCANCD300	21.700/ 47.840

CANopen IP 20 straight connector 9-way female SUB-D with line terminator that can be deactivated	7	–	TSXCANKCDF180T	0.049/ 0.108
--	---	---	----------------	-----------------

IP 20 CANopen right angle connector (6) 9-way female SUB-D with line terminator that can be deactivated	7	–	TSXCANKCDF90T	0.046/ 0.101
---	---	---	---------------	-----------------

- (1) Altivar Machine ATV320 products with a compact control block require the **VW3A3600** option module adapter in order to use any communication option modules.
- (2) The Modbus serial link always uses the RJ45 communication port. If simultaneous use of the Modbus serial link and the CANopen machine bus is required, a CANopen communication module is needed.
- (3) The Altivar Machine ATV320 drive can only take one communication module.
- (4) When one of the CANopen communication modules is inserted in the Altivar Machine ATV320 drive, CANopen communication via the RJ45 communication port on the front is disabled.
- (5) Standard environment:
 - No particular environmental constraints
 - Operating temperature between 5 and 60 °C/41 and 140 °F
 - Fixed installation
 Harsh environment:
 - Resistance to hydrocarbons, industrial oils, detergents, solder splashes
 - Relative humidity up to 100%
 - Saline atmosphere
 - Operating temperature between -10 and +70 °C/14 and 158 °F
 - Significant temperature variations
- (6) Incompatible with side-by-side mounting.
- (7) Please refer to the "Modicon M241 logic controller", "Modicon M251 logic controller", and "Magelis SCU small HMI controllers" catalogs.
- (8) Cable dependent on the type of controller or PLC; please refer to the corresponding catalog.

Variable speed drives

Altivar Machine ATV320

Communication buses and networks

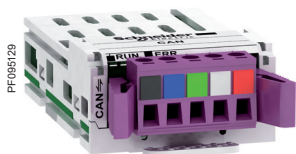

VW3A3628

Modicon M251 (4)

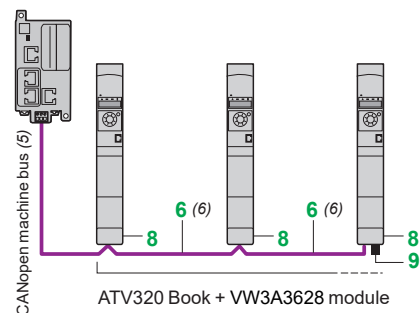

Example of connection to the CANopen machine bus via screw terminals

CANopen machine bus (continued) (1)(7)

Description	Item no.	Length m/ft	Unit reference	Weight kg/lb
-------------	----------	-------------	----------------	--------------

Connection via terminals with VW3A3628 CANopen module

CANopen communication module (2) (3)	8	–	VW3A3628	–
--------------------------------------	---	---	----------	---

Port: 1 x 5-way screw terminal block

CANopen line terminator for screw terminal connector	9	–	TCSCAR01NM120	–
--	---	---	---------------	---

Other connection accessories and cordsets

IP 20 CANopen cordsets equipped with 2 x 9-way female SUB-D connectors. Standard cable, CÉ marking Low smoke zero halogen Flame retardant (IEC 60332-1)	–	0.3/ 0.98	TSXCANCADD03	0.091/ 0.201
	–	1.0/ 3.28	TSXCANCADD1	0.143/ 0.315
	–	3.0/ 9.84	TSXCANCADD3	0.295/ 0.650
	–	5.0/ 16.40	TSXCANCADD5	0.440/ 0.970

IP 20 CANopen cordsets equipped with 2 x 9-way female SUB-D connectors. Standard cable, UL certification, CÉ marking Flame retardant (IEC 60332-2)	–	0.3/ 0.98	TSXCANCBDD03	0.086/ 0.190
	–	1.0/ 3.28	TSXCANCBDD1	0.131/ 0.289
	–	3.0/ 9.84	TSXCANCBDD3	0.268/ 0.591
	–	5.0/ 16.40	TSXCANCBDD5	0.400/ 0.882

IP 20 CANopen junction boxes equipped with: ■ 4 x 9-way male SUB-D connectors + screw terminal block for trunk cable tap link ■ Line terminator	–	–	TSXCANTDM4	0.196/ 0.432
---	---	---	------------	-----------------

IP 20 CANopen junction boxes equipped with: ■ 2 screw terminal blocks for trunk cable tap link ■ 2 RJ45 connectors for connecting drives ■ 1 RJ45 connector for connecting a PC	–	–	VW3CANTAP2	0.480/ 1.058
--	---	---	------------	-----------------

(1) The Modbus serial link always uses the RJ45 communication port. If simultaneous use of the Modbus serial link and the CANopen machine bus is required, a CANopen communication module is needed.

(2) The Altivar Machine ATV320 drive can only take one communication module.

(3) When one of the CANopen communication modules is inserted in the Altivar Machine ATV320 drive, CANopen communication via the RJ45 communication port is disabled.

(4) Please refer to the "Modicon M241 logic controller" and "Modicon M251 logic controller" catalogs.

(5) Cable dependent on the type of controller or PLC; please refer to the corresponding catalog.

(6) See page 60889/4 for item "6".

(7) Altivar Machine ATV320 products with a compact control block require the VW3A3600 option module adapter in order to use any communication option modules.



VW3A3616

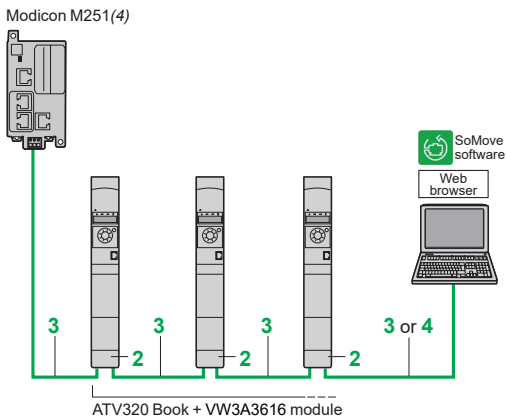
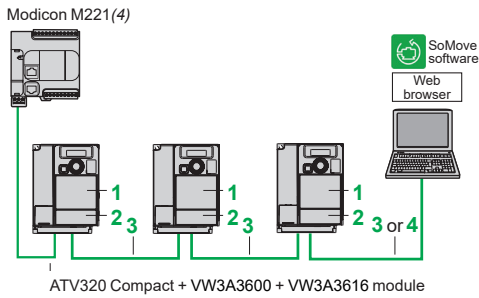

Example of connection on an EtherNet/IP network

Modbus TCP network and EtherNet/IP network (1) (5)

Description	Item no.	Length m/ft (3)	Reference	Weight kg/lb
Communication module				
Modbus TCP and EtherNet/IP network module	2	–	VW3A3616	0.300/ 0.661

For connection to the Modbus TCP network or EtherNet/IP network
 Ports: 2 RJ45 connectors
 ■ 10/100 Mbps, half duplex and full duplex
 ■ Embedded web server

Requires cordsets
 490NTW000●●/●●U or
 490NTC000●●/●●U

ConneXium cordsets (2) (3)

Straight shielded twisted pair cordsets	3	2.0/ 6.56	490NTW00002	–
equipped with 2 RJ45 connectors		5.0/ 16.40	490NTW00005	–
Conforming to EIA/TIA-568 category 5 and IEC 11801/EN 50173-1, class D standards		12/ 39.37	490NTW00012	–
Crossed shielded twisted pair cordsets	4	5.0/ 16.40	490NTC00005	–
equipped with 2 RJ45 connectors		15/ 49.21	490NTC00015	–
Conforming to EIA/TIA-568 category 5 and IEC 11801/EN 50173-1, class D standards				
Straight shielded twisted pair cables	3	2.0/ 6.56	490NTW00002U	–
equipped with 2 RJ45 connectors		5.0/ 16.40	490NTW00005U	–
Conforming to UL and CSA 22.1 standards		12/ 39.37	490NTW00012U	–
Crossed shielded twisted pair cordsets	3	5.0/ 16.40	490NTC00005U	–
equipped with 2 RJ45 connectors		15/ 49.21	490NTC00015U	–
Conforming to UL and CSA 22.1 standards				

(1) The Altivar Machine ATV320 drive can only take one communication module.

(2) For other ConneXium connection accessories, please refer to our website www.schneider-electric.com.

(3) Also available in 40 m/131.23 ft and 80 m/262.46 ft lengths (2).

(4) Please refer to the "M221/M241/M251 Automation platform" catalog.

(5) Altivar Machine ATV320 products with a compact control block require the **VW3A3600** option module adapter (item 1) in order to use any communication option modules.



VW3A3607

PROFIBUS DP V1 bus (1)(2)

Description	Reference	Weight kg/lb
PROFIBUS DP V1 communication module Port: 1 x 9-way female SUB-D connector Conforming to PROFIBUS DP V1 Profiles supported: <ul style="list-style-type: none"> ■ CiA 402 drive ■ Profidrive Offers several message handling modes based on DP V1	VW3A3607	0.140/ 0.308

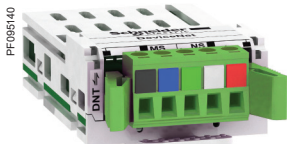

VW3A3609

DeviceNet bus (1)(2)

Description	Reference	Weight kg/lb
DeviceNet communication module Port: 1 removable 5-way screw connector Profiles supported: <ul style="list-style-type: none"> ■ CIP AC DRIVE ■ CiA 402 drive 	VW3A3609	—



VW3A3601

EtherCAT bus (1)(2)

Description	Reference	Weight kg/lb
EtherCAT communication module Port: 2 RJ45 connectors	VW3A3601	—



VW3A3619

POWERLINK network (1)(2)

Description	Reference	Weight kg/lb
Ethernet POWERLINK communication module Port: 2 RJ45 connectors	VW3A3619	0.300/ 0.660



VW3A3627

ProfiNet network (1)(2)

Description	Reference	Weight kg/lb
ProfiNet communication module Port: 2 RJ45 connectors	VW3A3627	0.300/ 0.660

(1) The Altivar Machine ATV320 drive can only take one communication module.

(2) Altivar Machine ATV320 products with a compact control block require the **VW3A3600** option module adapter in order to use any communication option modules.

Applications

Two types of combination are possible:

- Circuit breaker + drive: minimum combination. The circuit breaker can be mounted directly on **ATV320 book type less than 4kW** drives using the bracket for GV2/ATV320 direct mounting (**VW3A9921**) and the adapter plate (**GV2AF5**) (see [page 18](#)).
- With the combination of circuit breaker, contactor and variable speed drive, The circuit breaker provides protection against accidental short circuits, disconnection and isolation.

For ATV320...WS, circuit breaker can't be integrated inside.

For ATV320...W, the combination table of Circuit breaker, Rotary handle kit(GVAPB65S or GV2APN03), and Base plate(VW3A9922) is in installation manual.

Example:

ATV320U07N4W + GV2L08 + GVAPB65S +VW3A9922

ATV320U55N4W + GV2L22 + GV2APN03

GVAPB65S used below 4kW, GV2APN03 used for 5.5kW and 7.5kW

A contactor can be used downstream of the drive to help ensure the motor is isolated on stopping. In this case, the contactor size should be category AC-3 depending on the associated motor, only for operation between 25 Hz and 500 Hz.

The Altivar Machine ATV320 drive is protected electronically against short circuits between phases and between phase and ground. It therefore provides continuity of service and thermal monitoring of the motor.



GV2 / ATV320 direct mounting: **GV2L08 + (VW3A9921 + GV2AF5)** (5) (6) + **ATV320U07N4B**

Motor starters: Circuit breaker + Drive

Standard power ratings of three-phase 4-pole 50/60 Hz motors (2)	Variable speed drive Reference (3)	Circuit breaker (1)	
		Reference	Circuit breaker mounted directly on ATV320 (4)
kW	HP		
Single-phase supply voltage: 200...240 V 50/60 Hz			
0.18	0.25	ATV320U02M2●	GV2L08 (5)
0.37	0.5	ATV320U04M2●	GV2L10 (5)
0.55	0.75	ATV320U06M2●	GV2L14 (5)
0.75	1	ATV320U07M2●	GV2L16 (5)
1.1	1.5	ATV320U11M2●	GV2L16 (5)
1.5	2	ATV320U15M2●	GV2L20 (5)
2.2	3	ATV320U22M2●	GV2L22 (5)
Three-phase supply voltage: 200...240 V 50/60 Hz			
0.18	0.25	ATV320U02M3C	GV2L07 (5)
0.37	0.5	ATV320U04M3C	GV2L08 (5)
0.55	0.75	ATV320U06M3C	GV2L10 (5)
0.75	1	ATV320U07M3C	GV2L14 (5)
1.1	1.5	ATV320U11M3C	GV2L14 (5)
1.5	2	ATV320U15M3C	GV2L16 (5)
2.2	3	ATV320U22M3C	GV2L20 (5)
3	4	ATV320U30M3C	GV2L22 (5)
4	5	ATV320U40M3C	GV2L22 (5)
5.5	7.5	ATV320U55M3C	GV3L40 (5)
7.5	10	ATV320U75M3C	GV3L50 (5)
11	15	ATV320D11M3C	GV3L65 (5)
15	20	ATV320D15M3C	GV3L80

(1) GV2L, GV3L: TeSys magnetic motor circuit breakers; accessories (see [page 55](#)).

(2) The HP values given are NEC-compliant (National Electrical Code).

(3) For the complete reference, replace ● with B, C, W, WS version.

(4) The circuit breaker can be mounted directly only on the book format drive **ATV320U●●M2B** and **ATV320U04N4B...U40N4B**.

(5) **GV●L●●** circuit breaker reference are not UL compliant. To achieve UL Type E compliance **GV●P●●** thermal magnetic circuit breaker must be used.

(6) To be ordered separately (see [page 17](#)), see note (4) for compatibility.



Motor starters: Circuit breaker + Drive				
Standard power ratings of three-phase 4-pole 50/60 Hz motors (2)		Variable speed drive Reference (3)	Circuit breaker (1) Reference	Circuit breaker mounted directly on ATV320 (4)
kW	HP			
Three-phase supply voltage: 380...500 V 50/60 Hz				
0.37	0.5	ATV320U04N4●	GV2L07 (5) (7)	With accessories VW3A9921 + GV2AF5 (6)
0.55	0.75	ATV320U06N4●	GV2L08 (5) (7)	
0.75	1	ATV320U07N4●	GV2L08 (5) (7)	
1.1	1.5	ATV320U11N4●	GV2L10 (5) (7)	
1.5	2	ATV320U15N4●	GV2L14 (5) (7)	
2.2	3	ATV320U22N4●	GV2L14 (5) (7)	
3	4	ATV320U30N4●	GV2L16 (5) (7)	
4	5	ATV320U40N4●	GV2L16 (5) (7)	
5.5	7.5	ATV320U55N4●	GV2L22 (5)	–
7.5	10	ATV320U75N4●	GV2L32 (5)	
11	15	ATV320D11N4●	GV3L40 (5)	
15	20	ATV320D15N4●	GV3L50 (5)	
Three-phase supply voltage: 525...600 V 50/60 Hz				
0.75	1	ATV320U07S6C	GV3P13	–
1.5	2	ATV320U15S6C	GV3P13	
2.2	3	ATV320U22S6C	GV3P13	
4	5	ATV320U40S6C	GV3P13	
5.5	7.5	ATV320U55S6C	GV3P13	
7.5	10	ATV320U75S6C	GV3P18	
11	15	ATV320D11S6C	GV3P25	
15	20	ATV320D15S6C	GV3P32	

(1) GV2L, GV3L: TeSys magnetic motor circuit breakers; accessories (see page 55).
 (2) The HP values given are NEC-compliant (National Electrical Code).
 (3) For the complete reference, replace ● with B, C, W, WS version.
 (4) The circuit breaker can be mounted directly only on the book format drive ATV320U●●M2B and ATV320U04N4B...U40N4B.
 (5) GV●L●● circuit breaker reference are not UL compliant. To achieve UL Type E compliance GV●P●● thermal magnetic circuit breaker must be used.
 (6) To be ordered separately (see page 17), see note (4) for compatibility.
 (7) A GV2P TeSys thermal magnetic circuit breaker with the same rating can also be used with ATV320U04N4●...U40N4● drives. The thermal release should then be set to maximum to inhibit this function.

Variable speed drives

Altivar Machine ATV320

Motor starters: circuit breaker + contactor + drive



GV2L14 + LC1D09 +
ATV320U15N4B / ATV320U04N4C

Motor starters: Circuit breaker + Contactor + Drive

Standard power rating of 50/60 Hz 4-pole motors (3)		Variable speed drive Reference (4)	Circuit breaker Rating (1)	LRM (1)		Contactor (2)
			Reference	A	A	Reference (5)
kW	HP					
Single-phase supply voltage: 200...240 V 50/60 Hz						
0.18	0.25	ATV320U02M2●	GV2L08 (6)	4	51	LC1D09●●
0.37	0.5	ATV320U04M2●	GV2L10 (6)	6.3	78	LC1D09●●
0.55	0.75	ATV320U06M2●	GV2L14 (6)	10	138	LC1D09●●
0.75	1	ATV320U07M2●	GV2L16 (6)	14	170	LC1D09●●
1.1	1.5	ATV320U11M2●	GV2L16 (6)	14	170	LC1D09●●
1.5	2	ATV320U15M2●	GV2L20 (6)	18	223	LC1D09●●
2.2	3	ATV320U22M2●	GV2L22 (6)	25	327	LC1D09●●
Three-phase supply voltage: 200...240 V 50/60 Hz						
0.18	0.25	ATV320U02M3C	GV2L07 (6)	2.5	33.5	LC1D09●●
0.37	0.5	ATV320U04M3C	GV2L08 (6)	4	51	LC1D09●●
0.55	0.75	ATV320U06M3C	GV2L10 (6)	6.3	78	LC1D09●●
0.75	1	ATV320U07M3C	GV2L14 (6)	10	138	LC1D09●●
1.1	1.5	ATV320U11M3C	GV2L14 (6)	10	138	LC1D09●●
1.5	2	ATV320U15M3C	GV2L16 (6)	14	170	LC1D09●●
2.2	3	ATV320U22M3C	GV2L20 (6)	18	223	LC1D09●●
3	4	ATV320U30M3C	GV2L22 (6)	25	327	LC1D09●●
4	5	ATV320U40M3C	GV2L22 (6)	25	327	LC1D09●●
5.5	7.5	ATV320U55M3C	GV3L40 (6)	40	560	LC1D09●●
7.5	10	ATV320U75M3C	GV3L50 (6)	50	700	LC1D18●●
11	15	ATV320D11M3C	GV3L65 (6)	65	910	LC1D25●●
15	20	ATV320D15M3C	GV3L80	80	1100	LC1D32●●

- (1) GV2L, GV3L: TeSys magnetic motor circuit breakers; accessories (see page 55).
- (2) Composition of TeSys contactors LC1D09/D18/D25/D32: 3 poles + 1 NO auxiliary contact + 1 NC auxiliary contact.
- (3) The HP values given are NEC-compliant (National Electrical Code).
- (4) For the complete reference, replace ● with B, C, W or WS.
- (5) Replace ●● with the control circuit voltage reference given in the table below:

AC control circuit	Volts ~	24	48	115	230	230/240
LC1D	50/60 Hz	B7	E7	FE7	P7	U7

For other voltages between 24 V and 660 V, or a DC control circuit, please refer to the "Motor starter solutions - Control and protection components" catalog or visit our web site: www.schneider-electric.com.

- (6) GV●L●● circuit breaker reference are not UL compliant. To achieve UL Type E compliance GV●P●● thermal magnetic circuit breaker must be used.

Variable speed drives

Altivar Machine ATV320

Motor starters: circuit breaker + contactor + drive



GV2L14 + LC1D09 +
ATV320U15N4B / ATV320U04N4C

Motor starters: Circuit breaker + Contactor + Drive

Standard power rating of 50/60 Hz 4-pole motors (3)		Variable speed drive Reference (4)	Circuit breaker Rating (1)	LRM		Contactor (2)
			Reference	A	A	Reference (5)
kW	HP					
Three-phase supply voltage: 380...500 V 50/60 Hz						
0.37	0.5	ATV320U04N4●	GV2L07 (6)	2.5	33.5	LC1D09●●
0.55	0.75	ATV320U06N4●	GV2L08 (6)	4	51	LC1D09●●
0.75	1	ATV320U07N4●	GV2L08 (6)	4	51	LC1D09●●
1.1	1.5	ATV320U11N4●	GV2L10 (6)	6.3	78	LC1D09●●
1.5	2	ATV320U15N4●	GV2L14 (6)	10	138	LC1D09●●
2.2	3	ATV320U22N4●	GV2L14 (6)	10	138	LC1D09●●
3	4	ATV320U30N4●	GV2L16 (6)	14	170	LC1D09●●
4	5	ATV320U40N4●	GV2L16 (6)	14	170	LC1D09●●
5.5	7.5	ATV320U55N4●	GV2L22 (6)	25	327	LC1D09●●
7.5	10	ATV320U75N4●	GV2L32 (6)	32	416	LC1D18●●
11	15	ATV320D11N4●	GV3L40 (6)	40	560	LC1D25●●
15	20	ATV320D15N4●	GV3L50 (6)	50	700	LC1D32●●
Three-phase supply voltage: 525...600 V 50/60 Hz						
0.75	1	ATV320U07S6C	GV3P13	13	182	LC1D09●●
1.5	2	ATV320U15S6C	GV3P13	13	182	LC1D09●●
2.2	3	ATV320U22S6C	GV3P13	13	182	LC1D09●●
4	5	ATV320U40S6C	GV3P13	13	182	LC1D09●●
5.5	7.5	ATV320U55S6C	GV3P13	13	182	LC1D09●●
7.5	10	ATV320U75S6C	GV3P18	18	252	LC1D09●●
11	15	ATV320D11S6C	GV3P25	25	350	LC1D18●●
15	20	ATV320D15S6C	GV3P32	32	448	LC1D25●●

(1) GV2L, GV3L: TeSys magnetic motor circuit breakers; accessories (see page 55).
 (2) Composition of TeSys contactors LC1D09/D18/D25/D32: 3 poles + 1 NO auxiliary contact + 1 NC auxiliary contact.
 (3) The HP values given are NEC-compliant (National Electrical Code).
 (4) For the complete reference, replace ● with B, C, W, WS version.
 (5) Replace ●● with the control circuit voltage reference given in the table below:

AC control circuit						
	Volts ~	24	48	115	230	230/240
LC1D	50/60 Hz	B7	E7	FE7	P7	U7

For other voltages between 24 V and 660 V, or a DC control circuit, please refer to the "Motor starter solutions - Control and protection components" catalog or visit our web site: www.schneider-electric.com.

(6) GV●L●● circuit breaker reference are not UL compliant. To achieve UL Type E compliance GV●P●● thermal magnetic circuit breaker must be used.

Variable speed drives

Altivar Machine ATV320

Drives with compact control block



IP20 drives with compact control block

Single-phase supply voltage: 200...240 V 50/60 Hz

Drives	W x H x D (1)	
	mm	in.
ATV320U02M2C	72 x 143 x 109	2.83 x 5.63 x 4.29
With EMC plate	72 x 188 x 109	2.83 x 7.40 x 4.29
With UL Type 1 conformity kit	72 x 195.5 x 109	2.83 x 7.70 x 4.29
ATV320U04M2C	72 x 143 x 128	2.83 x 5.63 x 5.04
With EMC plate	72 x 188 x 128	2.83 x 7.40 x 5.04
With UL Type 1 conformity kit	72 x 195.5 x 128	2.83 x 7.70 x 5.04
ATV320U06M2C	72 x 143 x 138	2.83 x 5.63 x 5.43
With EMC plate	72 x 188 x 138	2.83 x 7.40 x 5.43
With UL Type 1 conformity kit	72 x 195.5 x 138	2.83 x 7.70 x 5.43
ATV320U07M2C	72 x 143 x 138	2.83 x 5.63 x 5.43
With EMC plate	72 x 188 x 138	2.83 x 7.40 x 5.43
With UL Type 1 conformity kit	72 x 195.5 x 138	2.83 x 7.70 x 5.43
ATV320U11M2C	105 x 142 x 158	4.13 x 5.60 x 6.22
With EMC plate	105 x 188 x 158	4.13 x 7.40 x 6.22
With UL Type 1 conformity kit	105 x 210.5 x 158	4.13 x 8.29 x 6.22
ATV320U15M2C	105 x 142 x 158	4.13 x 5.60 x 6.22
With EMC plate	105 x 188 x 158	4.13 x 7.40 x 6.22
With UL Type 1 conformity kit	105 x 210.5 x 158	4.13 x 8.29 x 6.22
ATV320U22M2C	105 x 142 x 158	4.13 x 5.60 x 6.22
With EMC plate	105 x 188 x 158	4.13 x 7.40 x 6.22
With UL Type 1 conformity kit	105 x 210.5 x 158	4.13 x 8.29 x 6.22

Three-phase supply voltage: 380...500 V 50/60 Hz

ATV320U04N4C	105 x 143 x 158	4.13 x 5.63 x 6.22
With EMC plate	105 x 188 x 158	4.13 x 7.40 x 6.22
With UL Type 1 conformity kit	105 x 210.5 x 158	4.13 x 8.29 x 6.22
ATV320U06N4C	105 x 143 x 158	4.13 x 5.63 x 6.22
With EMC plate	105 x 188 x 158	4.13 x 7.40 x 6.22
With UL Type 1 conformity kit	105 x 210.5 x 158	4.13 x 8.29 x 6.22
ATV320U07N4C	105 x 143 x 158	4.13 x 5.63 x 6.22
With EMC plate	105 x 188 x 158	4.13 x 7.40 x 6.22
With UL Type 1 conformity kit	105 x 210.5 x 158	4.13 x 8.29 x 6.22
ATV320U11N4C	105 x 143 x 158	4.13 x 5.63 x 6.22
With EMC plate	105 x 188 x 158	4.13 x 7.40 x 6.22
With UL Type 1 conformity kit	105 x 210.5 x 158	4.13 x 8.29 x 6.22
ATV320U15N4C	105 x 143 x 158	4.13 x 5.63 x 6.22
With EMC plate	105 x 188 x 158	4.13 x 7.40 x 6.22
With UL Type 1 conformity kit	105 x 210.5 x 158	4.13 x 8.29 x 6.22
ATV320U22N4C	140 x 184 x 158	5.51 x 7.24 x 6.22
With EMC plate	140 x 227.9 x 158	5.51 x 8.97 x 6.22
With UL Type 1 conformity kit	140 x 236.5 x 158	5.51 x 9.31 x 6.22
ATV320U30N4C	140 x 184 x 158	5.51 x 7.24 x 6.22
With EMC plate	140 x 227.9 x 158	5.51 x 8.97 x 6.22
With UL Type 1 conformity kit	140 x 236.5 x 158	5.51 x 9.31 x 6.22
ATV320U40N4C	140 x 184 x 158	5.51 x 7.24 x 6.22
With EMC plate	140 x 227.9 x 158	5.51 x 8.97 x 6.22
With UL Type 1 conformity kit	140 x 236.5 x 158	5.51 x 9.31 x 6.22
ATV320U55N4C	150 x 232 x 178	5.91 x 9.13 x 7.01
With EMC plate	150 x 308 x 178	5.91 x 21.13 x 7.01
With UL Type 1 conformity kit	150 x 316 x 178	5.91 x 12.44 x 7.01
ATV320U75N4C	150 x 232 x 178	5.91 x 9.13 x 7.01
With EMC plate	150 x 308 x 178	5.91 x 21.13 x 7.01
With UL Type 1 conformity kit	150 x 316 x 178	5.91 x 12.44 x 7.01
ATV320D11N4C	180 x 330 x 198	7.09 x 12.99 x 7.80
With EMC plate	180 x 405 x 198	7.09 x 15.94 x 7.80
With UL Type 1 conformity kit	180 x 410.5 x 198	7.09 x 16.16 x 7.80
ATV320D15N4C	180 x 330 x 198	7.09 x 12.99 x 7.80
With EMC plate	180 x 405 x 198	7.09 x 15.94 x 7.80
With UL Type 1 conformity kit	180 x 410.5 x 198	7.09 x 16.16 x 7.80

Variable speed drives

Altivar Machine ATV320

Drives with compact control block



IP20 drives with compact control block

Three-phase supply voltage: 200...240 V 50/60 Hz

Drives	W x H x D (1)	
	mm	in.
ATV320U02M3C	72 x 143 x 109	2.83 x 5.63 x 4.29
With EMC plate	72 x 188 x 109	2.83 x 7.40 x 4.29
With UL Type 1 conformity kit	72 x 195.5 x 109	2.83 x 7.70 x 4.29
ATV320U04M3C	72 x 143 x 128	2.83 x 5.63 x 5.04
With EMC plate	72 x 188 x 128	2.83 x 7.40 x 5.04
With UL Type 1 conformity kit	72 x 195.5 x 128	2.83 x 7.70 x 5.04
ATV320U06M3C	72 x 143 x 138	2.83 x 5.63 x 5.43
With EMC plate	72 x 188 x 138	2.83 x 7.40 x 5.43
With UL Type 1 conformity kit	72 x 195.5 x 138	2.83 x 7.70 x 5.43
ATV320U07M3C	72 x 143 x 138	2.83 x 5.63 x 5.43
With EMC plate	72 x 188 x 138	2.83 x 7.40 x 5.43
With UL Type 1 conformity kit	72 x 195.5 x 138	2.83 x 7.70 x 5.43
ATV320U11M3C	105 x 143 x 138	4.13 x 5.63 x 5.43
With EMC plate	105 x 190 x 138	4.13 x 7.48 x 5.43
With UL Type 1 conformity kit	105 x 210.5 x 138	4.13 x 8.29 x 5.43
ATV320U15M3C	105 x 143 x 138	4.13 x 5.63 x 5.43
With EMC plate	105 x 190 x 138	4.13 x 7.48 x 5.43
With UL Type 1 conformity kit	105 x 210.5 x 138	4.13 x 8.29 x 5.43
ATV320U22M3C	105 x 143 x 138	4.13 x 5.63 x 5.43
With EMC plate	105 x 190 x 138	4.13 x 7.48 x 5.43
With UL Type 1 conformity kit	105 x 210.5 x 138	4.13 x 8.29 x 5.43
ATV320U30M3C	140 x 184 x 158	5.51 x 7.24 x 6.22
With EMC plate	140 x 228 x 158	5.51 x 8.98 x 6.22
With UL Type 1 conformity kit	140 x 236.5 x 158	5.51 x 9.31 x 6.22
ATV320U40M3C	140 x 184 x 158	5.51 x 7.24 x 6.22
With EMC plate	140 x 228 x 158	5.51 x 8.98 x 6.22
With UL Type 1 conformity kit	140 x 236.5 x 158	5.51 x 9.31 x 6.22
ATV320U55M3C	150 x 232 x 178	5.91 x 9.13 x 7.01
With EMC plate	150 x 308 x 178	5.91 x 21.13 x 7.01
With UL Type 1 conformity kit	150 x 316 x 178	5.91 x 12.44 x 7.01
ATV320U75M3C	150 x 232 x 178	5.91 x 9.13 x 7.01
With EMC plate	150 x 308 x 178	5.91 x 21.13 x 7.01
With UL Type 1 conformity kit	150 x 316 x 178	5.91 x 12.44 x 7.01
ATV320D11M3C	180 x 330 x 198	7.09 x 12.99 x 7.80
With EMC plate	180 x 405 x 198	7.09 x 15.94 x 7.80
With UL Type 1 conformity kit	180 x 410.5 x 198	7.09 x 16.16 x 7.80
ATV320D15M3C	180 x 330 x 198	7.09 x 12.99 x 7.80
With EMC plate	180 x 405 x 198	7.09 x 15.94 x 7.80
With UL Type 1 conformity kit	180 x 410.5 x 198	7.09 x 16.16 x 7.80

(1) The total depth excludes the module adapter, + 20 mm/0.79 in. in depth if combined with the option module adapter.

Variable speed drives

Altivar Machine ATV320

Drives with compact control block



Three-phase supply voltage: 525...600 V 50/60 Hz

ATV320U07S6C	105 x 142 x 158	4.13 x 5.59 x 6.22
With EMC plate	105 x 188 x 158	4.13 x 7.4 x 6.22
With UL Type 1 conformity kit	105 x 196 x 158	4.13 x 7.72 x 6.22
ATV320U15S6C	105 x 142 x 158	4.13 x 5.59 x 6.22
With EMC plate	105 x 188 x 158	4.13 x 7.4 x 6.22
With UL Type 1 conformity kit	105 x 196 x 158	4.13 x 7.72 x 6.22
ATV320U22S6C	140 x 184 x 158	5.51 x 7.24 x 6.22
With EMC plate	140 x 227.9 x 158	5.51 x 8.97 x 6.22
With UL Type 1 conformity kit	140 x 236.5 x 158	5.51 x 9.31 x 6.22
ATV320U40S6C	140 x 184 x 158	5.51 x 7.24 x 6.22
With EMC plate	140 x 227.9 x 158	5.51 x 8.97 x 6.22
With UL Type 1 conformity kit	140 x 236.5 x 158	5.51 x 9.31 x 6.22
ATV320U55S6C	150 x 232 x 178	5.90 x 9.13 x 7.01
With EMC plate	150 x 308 x 178	5.90 x 12.13 x 7.01
With UL Type 1 conformity kit	150 x 316 x 178	5.90 x 12.44 x 7.01
ATV320U75S6C	150 x 232 x 178	5.90 x 9.13 x 7.01
With EMC plate	150 x 308 x 178	5.90 x 12.13 x 7.01
With UL Type 1 conformity kit	150 x 316 x 178	5.90 x 12.44 x 7.01
ATV320D11S6C	180 x 330 x 198	7.08 x 12.99 x 7.79
With EMC plate	180 x 404 x 198	7.08 x 15.9 x 7.79
With UL Type 1 conformity kit	180 x 410 x 198	7.08 x 16.14 x 7.79
ATV320D15S6C	180 x 330 x 198	7.08 x 12.99 x 7.79
With EMC plate	180 x 404 x 198	7.08 x 15.9 x 7.79
With UL Type 1 conformity kit	180 x 410 x 198	7.08 x 16.14 x 7.79

(1) The total depth excludes the module adapter, + 20 mm/0.79 in. in depth if combined with the option module adapter.

Variable speed drives

Altivar Machine ATV320

Drives with book control block

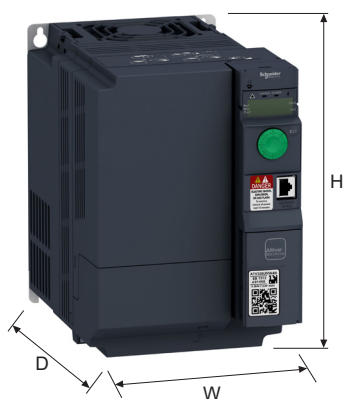

Drives with book control block

Single-phase supply voltage: 200...240 V 50/60 Hz

Drives	W x H x D	
	mm	in.
ATV320U02M2B	45 x 325 x 245	1.77 x 12.8 x 9.64
ATV320U04M2B	45 x 325 x 245	1.77 x 12.8 x 9.64
ATV320U06M2B	45 x 325 x 245	1.77 x 12.8 x 9.64
ATV320U07M2B	45 x 325 x 245	1.77 x 12.8 x 9.64
ATV320U11M2B	60 x 325 x 245	2.63 x 12.8 x 9.64
ATV320U15M2B	60 x 325 x 245	2.63 x 12.8 x 9.64
ATV320U22M2B	60 x 325 x 245	2.63 x 12.8 x 9.64

Three-phase supply voltage: 380...500 V 50/60 Hz

Drives	W x H x D	
	mm	in.
ATV320U04N4B	45 x 325 x 245	1.77 x 12.8 x 9.64
ATV320U06N4B	45 x 325 x 245	1.77 x 12.8 x 9.64
ATV320U07N4B	45 x 325 x 245	1.77 x 12.8 x 9.64
ATV320U11N4B	45 x 325 x 245	1.77 x 12.8 x 9.64
ATV320U15N4B	45 x 325 x 245	1.77 x 12.8 x 9.64
ATV320U22N4B	60 x 325 x 245	2.63 x 12.8 x 9.64
ATV320U30N4B	60 x 325 x 245	2.63 x 12.8 x 9.64
ATV320U40N4B	60 x 325 x 245	2.63 x 12.8 x 9.64
ATV320U55N4B	150 x 232 x 232	5.90 x 9.13 x 9.13
With EMC plate	150 x 308 x 232	5.90 x 12.1 x 9.13
With UL Type 1 conformity kit	155 x 314 x 240	6.10 x 12.36 x 9.45
ATV320U75N4B	150 x 232 x 232	5.90 x 9.13 x 9.13
With EMC plate	150 x 308 x 232	5.90 x 12.1 x 9.13
With UL Type 1 conformity kit	155 x 314 x 240	6.10 x 12.36 x 9.45
ATV320D11N4B	180 x 330 x 232	7.09 x 13.0 x 9.13
With EMC plate	180 x 404 x 232	7.09 x 15.9 x 9.13
With UL Type 1 conformity kit	185 x 408.5 x 250	7.28 x 16.08 x 9.84
ATV320D15N4B	180 x 330 x 232	7.09 x 13.0 x 9.13
With EMC plate	180 x 404 x 232	7.09 x 15.9 x 9.13
With UL Type 1 conformity kit	185 x 408.5 x 250	7.28 x 16.08 x 9.84

Variable speed drives

Altivar Machine ATV320

Drives with compact control block

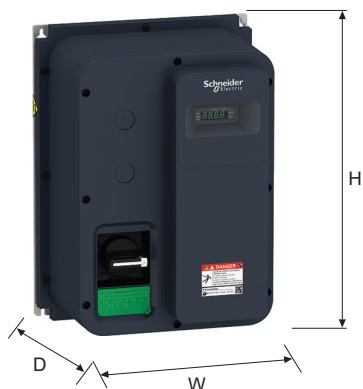

IP66 drive without vario and IP65 drive with vario

Single-phase supply voltage: 200...240 V 50/60 Hz

Drives	W x H x D	
	mm	in.
ATV320U02M2W	250 x 340 x 182	9.84 x 13.38 x 7.16
ATV320U02M2WS		
ATV320U04M2W	250 x 340 x 182	9.84 x 13.38 x 7.16
ATV320U04M2WS		
ATV320U06M2W	250 x 340 x 182	9.84 x 13.38 x 7.16
ATV320U06M2WS		
ATV320U07M2W	250 x 340 x 182	9.84 x 13.38 x 7.16
ATV320U07M2WS		
ATV320U11M2W	250 x 340 x 235	9.84 x 13.38 x 9.25
ATV320U11M2WS		
ATV320U15M2W	250 x 340 x 235	9.84 x 13.38 x 9.25
ATV320U15M2WS		
ATV320U22M2W	250 x 340 x 235	9.84 x 13.38 x 9.25
ATV320U22M2WS		

Three-phase supply voltage: 380...500 V 50/60 Hz

Drives	W x H x D	
	mm	in.
ATV320U04N4W	250 x 340 x 200	9.84 x 13.38 x 7.87
ATV320U04N4WS		
ATV320U06N4W	250 x 340 x 200	9.84 x 13.38 x 7.87
ATV320U06N4WS		
ATV320U07N4W	250 x 340 x 200	9.84 x 13.38 x 7.87
ATV320U07N4WS		
ATV320U11N4W	250 x 340 x 200	9.84 x 13.38 x 7.87
ATV320U11N4WS		
ATV320U15N4W	250 x 340 x 200	9.84 x 13.38 x 7.87
ATV320U15N4WS		
ATV320U22N4W	250 x 340 x 235	9.84 x 13.38 x 9.25
ATV320U22N4WS		
ATV320U30N4W	250 x 340 x 235	9.84 x 13.38 x 9.25
ATV320U30N4WS		
ATV320U40N4W	250 x 340 x 235	9.84 x 13.38 x 9.25
ATV320U40N4WS		
ATV320U55N4W	320 x 521 x 335	12.59 x 20.51 x 13.19
ATV320U55N4WS		
ATV320U75N4W	320 x 521 x 335	12.59 x 20.51 x 13.19
ATV320U75N4WS		

Variable speed drives

Altivar Machine ATV320

Line chokes, Motor chokes, Braking resistors,
Additional EMC input filters

Line chokes		
Line chokes	W x H x D	
	mm	in.
VW3A4551	100 x 135 x 60	3.94 x 5.31 x 2.36
VW3A4552	130 x 155 x 90	5.11 x 6.10 x 3.54
VW3A4553	130 x 155 x 90	5.11 x 6.10 x 3.54
VW3A4554	155 x 170 x 135	5.90 x 6.69 x 5.31
VW3A4555	180 x 210 x 160	7.09 x 8.27 x 6.30
VZ1L007UM50	60 x 100 x 95	2.36 x 9.94 x 3.74
VZ1L018UM20	85 x 120 x 105	3.35 x 4.72 x 4.13

Motor chokes		
Motor chokes	W x H x D	
	mm	in.
VW3A4552	130 x 155 x 90	5.11 x 6.10 x 3.54
VW3A4553	130 x 155 x 90	5.11 x 6.10 x 3.54
VW3A4554	155 x 170 x 135	5.90 x 6.69 x 5.31
VW3A4555	180 x 210 x 160	7.09 x 8.27 x 6.30
VW3A4556	270 x 210 x 180	10.6 x 8.27 x 7.09

Braking resistors		
Braking resistors	W x H x D	
	mm	in.
VW3A7603R07	251 x 204 x 15.5	9.88 x 8.03 x 0.61
VW3A7603R30		
VW3A7604R07	257 x 204 x 30	10.11 x 8.03 x 1.18
VW3A7604R30		
VW3A7605R07	145 x 98 x 15.5	5.70 x 3.85 x 0.61
VW3A7605R30		
VW3A7606R07	251 x 204 x 15.5	9.88 x 8.03 x 0.61
VW3A7606R30		
VW3A7608R07	145 x 98 x 15.5	5.70 x 3.85 x 0.61
VW3A7608R30		
VW3A7730	105 x 295 x 100	4.13 x 11.61 x 3.94
VW3A7731	105 x 345 x 100	4.13 x 13.58 x 3.94
VW3A7732	175 x 345 x 100	6.89 x 13.58 x 3.94
VW3A7733	190 x 570 x 180	7.48 x 22.44 x 7.09
VW3A7734	250 x 490 x 180	9.84 x 19.29 x 7.09
VW3A7735	250 x 490 x 180	9.84 x 19.29 x 7.09
VW3A7736	485 x 410 x 485	19.09 x 16.14 x 19.09

Additional EMC input filters		
EMC filters	W x H x D	
	mm	in.
VW3A31401	72 x 195 x 37	2.82 x 7.63 x 1.45
VW3A31402	72 x 195 x 37	2.82 x 7.63 x 1.45
VW3A31403	107 x 195 x 35	4.2 x 7.63 x 1.37
VW3A31404	107 x 195 x 42	4.2 x 7.63 x 1.65
VW3A31405	140 x 235 x 35	5.48 x 9.2 x 1.37
VW3A31406	140 x 235 x 50	5.48 x 9.2 x 1.96
VW3A31407	180 x 305 x 60	7.09 x 12.01 x 2.36
VW3A31408	245 x 395 x 80	9.65 x 15.55 x 3.15
VW3A4420	72 x 195 x 37	2.82 x 7.63 x 1.45
VW3A4421	107 x 195 x 35	4.2 x 7.63 x 1.37
VW3A4422	107 x 195 x 42	4.2 x 7.63 x 1.65
VW3A4424	180 x 305 x 60	7.05 x 11.94 x 2.35
VW3A4425	245 x 395 x 60	9.59 x 15.46 x 2.35
VW3A4426	140 x 235 x 35	5.48 x 9.2 x 1.37
VW3A4461	70 x 315 x 60	2.75 x 12.4 x 2.36
VW3A4462	78 x 315 x 75	3.07 x 12.4 x 2.95

Life Is On



Learn more about our products at
www.schneider-electric.com/drives

The information provided in this documentation contains general descriptions and/or technical characteristics of the performance of the products contained herein. This documentation is not intended as a substitute for and is not to be used for determining suitability or reliability of these products for specific user applications. It is the duty of any such user or integrator to perform the appropriate and complete risk analysis, evaluation and testing of the products with respect to the relevant specific application or use thereof. Neither Schneider Electric nor any of its affiliates or subsidiaries shall be responsible or liable for misuse of the information contained herein.

Design: Schneider Electric
Photos: Schneider Electric

Schneider Electric Industries SAS

Head Office
35, rue Joseph Monier - CS 30323
F-92500 Rueil-Malmaison Cedex
France

DIA2ED2160311EN
April 2020 - V8.0