

# Installation / User Manual

Photovoltaic Grid-connected  
Microinverter(Built-in WIFI-G3)

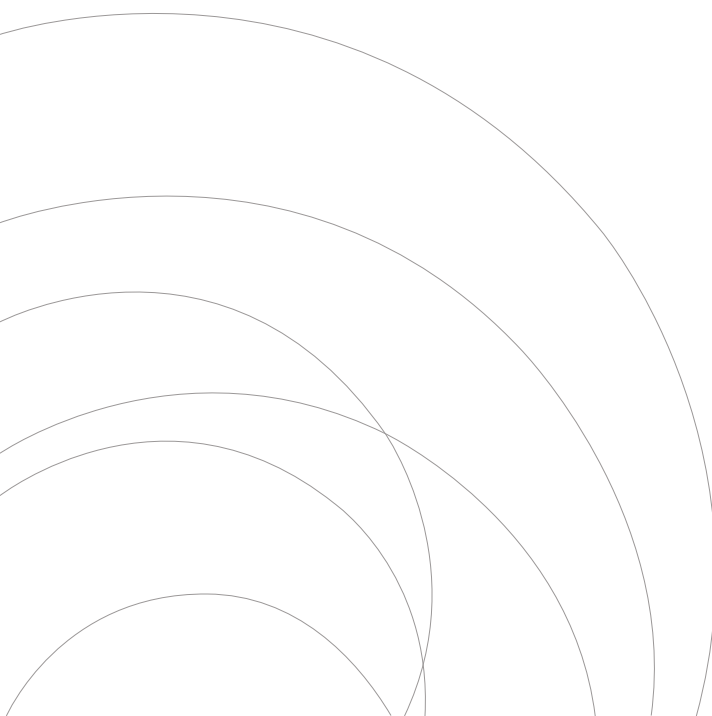

# Table of Contents

<b>Important Safety Instructions</b>	<b>01-03</b>
Safety Instructions	
Radio Interference Statement	
The Meaning of Symbols	
<b>Microinverter System Introduction</b>	<b>03-05</b>
Microinverters Maximize PV Energy Production	
More Reliable than Centralized or String Inverters	
Simple to Install	
<b>Microinverter Introduction</b>	<b>05</b>
<b>Microinverter System Installation</b>	<b>06-11</b>
Required Parts and Tools from You	
Parts list	
Installation Procedures	
<b>Microinverter System Operating Instructions</b>	<b>11-12</b>
<b>Troubleshooting</b>	<b>12-14</b>
Status Indications and Error Reporting	
Troubleshooting a Non-operating Microinverter	
<b>Replacement</b>	<b>15</b>
<b>Technical Data</b>	<b>15-16</b>
M60 / 80 /100 G3 Microinverter Datasheet	
<b>Wiring Diagram</b>	<b>17-18</b>
<b>Monitoring Platform</b>	<b>19</b>
<b>How to Configure the Microinverter to the Router Via Web</b>	<b>20-23</b>
<b>How to connect in APP</b>	<b>24-25</b>

---

---

---

## Important Safety Instructions

This manual contains important instructions to follow during installation and maintenance of the Photovoltaic Grid-connected Inverter(Microinverter).To reduce the risk of electrical shock and ensure the safe installation and operation of the Microinverter, the following symbols appear throughout this document to indicate dangerous conditions and important safety instructions.

Specifications subject to change without notice - please ensure you are using the latest manual found at the manufacturer website.

**WARNING:** This indicates a situation where failure to follow instructions may cause a serious hardware failure or personnel danger if not applied appropriately. Use extreme caution when performing this task.

**NOTE:** This indicates information that is important for optimized microinverter operation. Follow these instructions strictly.

## Safety Instructions

- ✓ **DO NOT** disconnect the PV module from the Microinverter without disconnecting the AC power.
- ✓ Only qualified professionals should install and/or replace the Microinverters.
- ✓ Perform all electrical installations in accordance with local electrical codes.
- ✓ Before installing or using the Microinverter, please read all instructions and cautionary markings in the technical documents and on the Microinverter system and the solar-array.
- ✓ Be aware that the body of the Microinverter is the heat sink and can reach a temperature of 80°C. To reduce risk of burns,do not touch the body of the Microinverter.
- ✓ **DO NOT** attempt to repair the Microinverter. If it fails, contact technical support to obtain an RMA number and start the replacement process. Damaging or opening the Microinverter will void the warranty.
- ✓ Caution!  
The external protective earthing conductor is connected to the inverter protective earthing terminal through AC connector.  
When connecting, connect the AC connector first to ensure the inverter earthing then do the DC connections.  
When disconnecting, disconnect the AC by opening the branch circuit breaker first

---

---

but maintain the protective earthing conductor in the branch circuit breaker connect to the inverter ,then disconnect the DC inputs.

- ✓ In any circumstance, do not connect DC input when AC connector is unplugged.
- ✓ Please install isolation switching devices on the AC side of the inverter.

## Radio Interference Statement

CE EMC Compliance: The equipment can comply with CE EMC, which are designed to protect against harmful interference in a residential installation. The equipment could radiate radio frequency energy and this might cause harmful interference to radio communications if not following the instructions when installing and using the equipment. But there is no guarantee that interference will not occur in a particular installation. If this equipment causes harmful interference to radio or television reception, the following measures might resolve the issues:

- A) Relocate the receiving antenna and keep it well away from the equipment.
- B) Consult the dealer or an experienced radio / TV technical for help.

Changes or modifications not expressly approved by the party responsible for compliance may void the user's authority to operate the equipment.

WiFi information







Frequency range: 2.412~2.472GHz

WiFi maximum transmitting power: 15.42dBm

Antenna: External Antenna

Antenna Gain: 3.00dBi

## The Meaning of Symbols

Can be OEM	Trademark.
	Caution, risk of electric shock.
	Caution, risk of burn - Do not touch.
	Caution, hot surface.
	Symbol for the marking of electrical and electronics devices according to Directive 2002/96/EC. Indicates that the device, accessories and the packaging must not be disposed as unsorted municipal waste and must be collected separately at the end of the usage. Please follow Local Ordinances or Regulations for disposal or contact an authorized representative of the manufacturer for information concerning the decommissioning of equipment.
	CE mark is attached to the solar inverter to verify that the unit follows the provisions of the European Low Voltage and EMC Directives.
	Refer to the operating instructions.
<p data-bbox="123 1066 231 1117">Qualified personnel</p>	<p data-bbox="280 989 889 1206">Person adequately advised or supervised by an electrically skilled person to enable him or her to perceive risks and to avoid hazards which electricity can create. For the purpose of the safety information of this manual, a "qualified person" is someone who is familiar with requirements for safety, refrigeration system and EMC and is authorized to energize, ground, and tag equipment, systems, and circuits in accordance with established safety procedures. The inverter and endues system may only be commissioned and operated by qualified personnel.</p>

## Microinverter System Introduction

The Microinverter is used in utility-interactive grid-tied applications, comprised of two key elements:

- Microinverter
- Router

This series microinverter has built-in WIFI module so it can communicate with router directly.

## M60 / 80 / 100G3

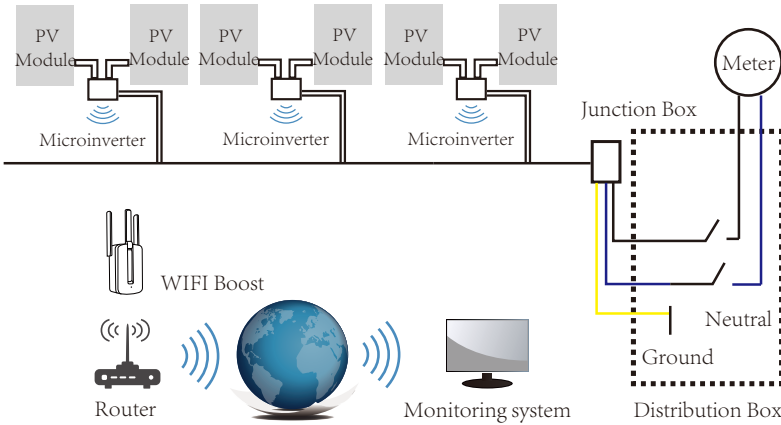

Inverter Model	SUN-M60G3-EU-Q0	SUN-M80G3-EU-Q0	SUN-M100G3-EU-Q0
PV Input Voltage	42.5V (20V~60V)		
PV Array MPPT Voltage Range	25V~55V		
No. of MPP Trackers	2		
No. of Strings per MPP Tracker	1		

**NOTE:** If the wireless signal in the area where the microinverter is installed is weak, it is necessary to add a wifi signal booster at a suitable place between the router and the microinverter.

This integrated system improves safety; maximizes solar energy harvest; increases system reliability, and simplifies solar system design, installation, maintenance, and management.

## Microinverters Maximize PV Energy Production

Each PV module has individual Maximum Peak Power Tracking (MPPT) controls, which ensures that the maximum power is exported to the utility grid regardless of the performance of the other PV modules in the array. When PV modules in the array are affected by shade, dust, orientation, or any situation in which one module underperforms compared with the other units, the Microinverter ensures top performance from the array by maximizing the performance of each module within the array.

---

---

## More Reliable than Centralized or String Inverters

The distributed Microinverter system ensures that no single point of system failure exists across the PV system. Microinverters are designed to operate at full power at ambient outdoor temperatures of up to 149°F (65°C). The inverter housing is designed for outdoor installation and complies with the IP67 environmental enclosure rating.

## Simple to Install

You can install individual PV modules in any combination of Module quantity, orientation, different type and power rate. The Ground wire (PE) of the AC cable is connected to the chassis inside of the Microinverter, potentially eliminating the installation of grounding wire (check local regulation).

Data collection adopts internal wifi, wireless router is needed near the microinverter. When complete the installation of microinverter, configure wireless router with internal wifi (refer to the wifi user manual). The data will be uploaded automatically. Users can monitor and manage the microinverter through corresponding website or APP.

## Microinverter Introduction

The Microinverters connect with the single-phase grid, and can also use multiple Microinverters in the form of single-phase grid to achieve three-phase grid.

For more information, please see the Technical Data page (P16) of this manual.

Model Number	AC grid	Max. # Per branch
SUN-M60G3-EU-Q0	50/60Hz, 230V	8 for 25A breaker
SUN-M80G3-EU-Q0	50/60Hz, 230V	6 for 25A breaker
SUN-M100G3-EU-Q0	50/60Hz, 230V	5 for 25A breaker

---

---

## Microinverter System Installation

A PV system using Microinverters is simple to install. Each Microinverter easily mounts on the PV racking, directly beneath the PV module(s). Low voltage DC wires connect from the PV module directly to the Microinverter, eliminating the risk of high DC voltage. Installation MUST comply with local regulations and technical rules.

**WARNING:** Perform all electrical installations in accordance with local electrical codes.

**WARNING:** Be aware that only qualified professionals should install and/or replace Microinverters.

**WARNING:** Before installing or using an Microinverter, please read all instructions and warnings in the technical documents and on the Microinverter system itself as well as on the PV array.

**WARNING:** Be aware that installation of this equipment includes the risk of electric shock.

**NOTE:** Strongly recommend to install Surge protection Devices in the dedicated meter box.

### Required Parts and Tools from you

In addition to your PV array and its associated hardware, you will need the following items:

- An or several AC connection junction boxes
- Mounting hardware suitable for module racking
- Sockets and wrenches for mounting hardware
- Continuous grounding conductor and grounding washers
- A Phillips screwdriver
- A torque wrench





---

---

## Parts list

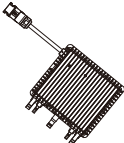
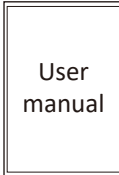
Please check the following table, to see whether all the parts are included in the package:

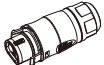
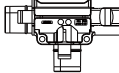
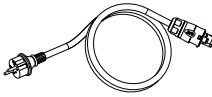
 <p>Microinverter x1</p>	 <p>User manual x1</p>	 <p>AC extension cable (optional) x N-1</p>
 <p>Bus AC connector (optional) x1</p>	 <p>T-connector (optional) x N-1</p>	 <p>Extension cable with European standard plug (optional) x 1</p>

\* Choose either Bus AC connector or Extension cable with European standard plug, can't use them in the same project.

---

---

## Installation Procedures

### Step 1 - Install the AC branch circuit junction box

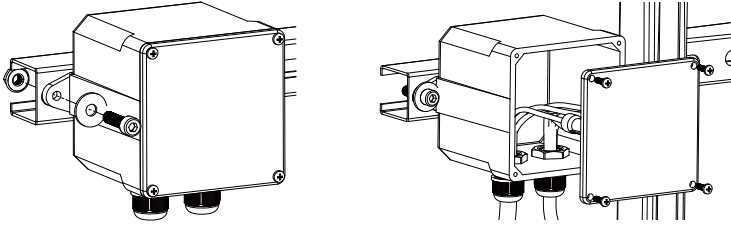

- Install an appropriate junction box at a suitable location on the PV racking system (typically at the end of a branch of modules).
- Connect the open wire end of the AC cable into the junction box using an appropriate gland or strain relief fitting.
- Wire the conductors of the AC(230/400Vac): L - red; N - black ;PE - yellow green.
- Connect the AC branch circuit junction box to the point of utility Grid Interconnection (Usually it is inside a distribution box).

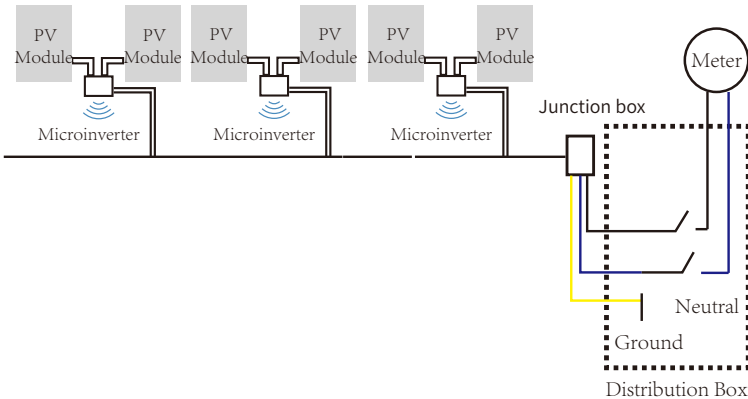

**WARNING:** Wiring colour code can be different according local regulation,check all the wires of the installation before connecting to the AC cable to be sure they match. Wrong cabling can damage irreparably the microinverters,such an issue is not covered by the warranty.

---

---

## Step 2 - Attach the Microinverters to the racking or the PV module frame

- Mark the location of the Microinverter on the rack, with respect to the PV module and junction box or any other obstructions.
- Mount one Microinverter at each of these locations using hardware recommended by your module racking vendor.

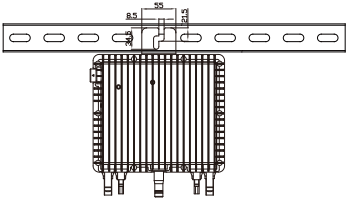

M60 / 80 / 100 G3 (2MPPT)

Mounting

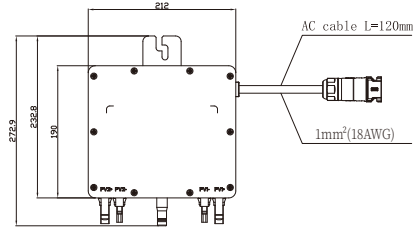

The AC wire on the micro inverter is a TC-ER wire with a wire cross-section area of  $1\text{mm}^2(18\text{AWG})$ .

**WARNING:** Prior to installing any of the microinverters, verify that the utility voltage at the point of common connection matches the voltage rating on microinverter label.

**WARNING:** Do not place the inverters (including DC and AC connectors) where exposed to the sun, rain or snow, even gap between modules. Allow a minimum of  $3/4$  (1.5cm.) between the roof and the bottom of the Microinverter to allow proper air flow.

### Step 3 - Connect the microinverters in parallel

- a. Check the Microinverter technical data page 5 for the maximum allowable number of Microinverters on each AC branch circuit.
- b. As to parallel connection, please refer to page (P17-P18), use the T-connector, AC extension cable, Bus AC connector(If only one branch, just use the Extension cable with European standard plug) to connect the Microinverter in each branch.

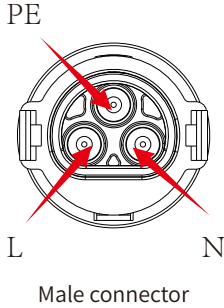

Model	Wire Size	Cable(mm) <sup>2</sup>	Torque value(max)	Max cable length
SUN-M60G3-EU-Q0	12AWG	2.5	8.5Nm	Outside cable (L+N+PE)20m
SUN-M80G3-EU-Q0	12AWG	2.5	8.5Nm	
SUN-M100G3-EU-Q0	12AWG	2.5	8.5Nm	

**WARNING:** DO NOT exceed maximum number of Microinverters in an AC branch circuit, as displayed on the page 5 of this manual.

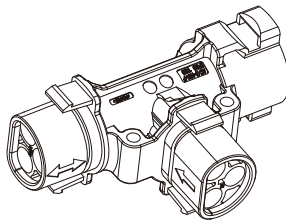

T-connector

**NOTE:** Port marked with two-way arrow on T-type plug can only connect with extended cable and Port marked with one-way arrow on T-type plug can only connect with Microinverter.

---

---

#### Step 4 - Connect the wire open of branch end to the junction box.

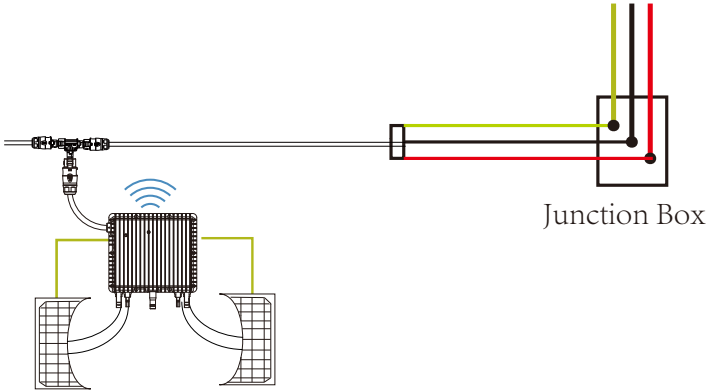

#### Step 5 - Connect Microinverter to the PV Modules

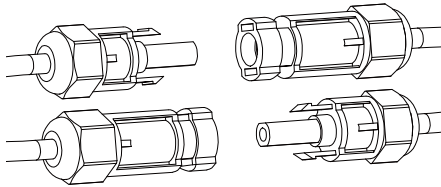

##### General Guidelines:

- a. PV modules should be connected to DC input ports of a microinverter.
- b. In order to meet the relevant regulatory requirements, the cable length must be <math><3M</math>. Please consult the local power operator to make sure that the DC cable complies with local regulations.

**NOTE:** When plugging in the DC cables, if AC already available, the Microinverter should immediately blink red light and will start work within the setting time (default 60 seconds). If AC is not available, the red light will blink 3 times quickly and repeat after one second until AC is connected.

## Microinverter System Operating Instructions

### To operate the microinverter PV system:

1. Turn ON the AC circuit breaker on each microinverter AC branch circuit.
2. Turn ON the main utility-grid AC circuit breaker. Your system will start producing power after a one-minute waiting time.

- 
- 
3. The units should start blinking red one minutes after turning on the AC circuit breaker. Then blue led blinking. This means they are producing power normally, the faster blinking of the blue led means more power generated.
  4. Configure the internal wifi module according to its user manual.
  5. The Microinverters will start to send performance data over wifi module to the network every 5 minutes.It enables customers to monitor performance data of each microinverter through website and APP.

**NOTE:** When AC power is applied but the microinverter not started up, about 0.1A current and 25VA(W) power for each microinverter may be measured by a power meter. This power is reactive power,not consume from utility grid.

## Troubleshooting

Qualified personnel can use the following troubleshooting steps if the PV system does not operate correctly:

### Status Indications and Error Reporting

#### Start up LED

One minute after DC power is first applied to the microinverter,one short red blinks indicate a successful microinverter startup sequence, be equal or greater than two short red blinks after DC power is first applied to the microinverter indicate a failure during microinverter setup.

#### Operation LED

Flashing Slow Blue	- Producing small power
Flashing Fast Blue	- Producing big power
Flashing Red	- Not producing power
Red blinking two times	- AC low-voltage or high-voltage
Red blinking three times	- Grid failure

---

---

## GFDI Error

A four time red LED indicates the Microinverter has detected a Ground Fault Detector Interrupter (GFDI) error in the PV system. Unless the GFDI error has been cleared, the LED will remain four times blinking.

## Other Faults

All other faults can be reported to the website and APP.

**WARNING:** Never disconnect the DC wire connectors under load. Ensure that no current is flowing in the DC wires prior to disconnecting. An opaque covering may be used to cover the module prior to disconnecting the module.

## Troubleshooting a non-operating Microinverter

There are two possible overall areas of trouble:

- A. The Microinverter itself may be having problems.
- B. The Microinverter itself is working fine but the communication between microinverter and network has problem. The items below refer to Microinverter issues, not communication issues:

One quick way to tell whether the issue is the Microinverter or the communication problem:

Diagnosing from the network:

- a. No-Data-Display: The website and APP don't display any data. Check the network configuration.
- b. Only display microinverter is online but no data. This maybe because server is updating.

---

---

## To troubleshoot a non-operating Microinverter, Follow the steps below in order:

1. Verify the utility voltage and frequency are within ranges shown in the Technical Data section of this manual.
2. Check the connection to the utility grid. Disconnect AC firstly, then disconnect DC and make sure the utility grid voltage can be measured at AC connector. Never disconnect the DC wires while the microinverter is producing power. Re-connect the DC module connectors and watch for three short LED flashes.
3. Check the AC branch circuit interconnection between all the microinverters. Verify each inverter is energized by the utility grid as described in the previous step.
4. Make sure that any AC breaker are functioning properly and are closed.
5. Check the DC connections between the microinverter and the PV module.
6. Verify the PV module DC voltage is within the allowable range shown in the Technical Data of this manual.
7. If the problem still persists, please contact technical support.

**WARNING:** Do not attempt to repair the microinverter. If troubleshooting methods fail, please call for Technical Support



---

---

## Replacement

### Follow the procedure to replace a failed Microinverter

- A. Disconnect the Microinverter from the PV Module, in the order shown below:
1. Disconnect the AC by turning off the branch circuit breaker.
  2. Disconnect the AC connector of the microinverter.
  3. Cover the module with an opaque cover.
  4. Disconnect the PV module DC wire connectors from the Microinverter.
  5. Remove the Microinverter from the PV array racking.
- B. Install a replaced Microinverter to the bracket then remove the opaque cover.  
Remember to observe the flashing LED light as soon as the new Microinverter is plugged into the DC cables.
- C. Connect the AC cable of the replacement Microinverter.

## Technical Data

**WARNING:** Be sure to verify the voltage and current specifications of your PV module match with those of the Microinverter. Please refer to the datasheet or user manual.

**WARNING:** You must match the DC operating voltage range of the PV module with the allowable input voltage range of the Microinverter.

**WARNING:** The maximum open circuit voltage of the PV module must not exceed the specified maximum input voltage of the inverter.

# M60G3/80G3/100G3 Microinverter Datasheet

Model	SUN-M60G3 -EU-Q0	SUN-M80G3 -EU-Q0	SUN-M100G3 -EU-Q0
<b>Input Data (DC)</b>			
Recommended input power(STC)	210-420W(2 Piece)	210-560W(2 Piece)	210-700W(2 Piece)
Maximum input DC voltage	60V		
MPPT Voltage Range	25~55V		
MPPT Full Power Voltage Range(V)	30V-55V	33V-55V	40V-55V
Min.DC input voltage(V)	20V		
Max DC short circuit current	19.5Ax2		
Max input current	13Ax2		
<b>Output Data (AC)</b>			
Rated output Power	600W	800W	1000W
Max.AC Output Power	600W	800W	1000W
Rated AC output current	2.8/2.7A	3.7/3.5A	4.6/4.4A
Max.AC Output Current	2.8/2.7A	3.7/3.5A	4.6/4.4A
Nominal voltage / range	220V/0.85Un-1.1Un 230V/ 0.85Un-1.1Un		
Nominal frequency	50/60Hz		
Extended frequency / range	45~55Hz / 55~65Hz		
Power factor	1		
Maximum unit per branch	8	6	5
Max. allowed altitude operating	< 4000m		
Max.inverter backfeed current to the array	0A		
Max output fault current	10A		
<b>Efficiency</b>			
CEC weighted efficiency	95%		
Peak inverter efficiency	96.5%		
Static MPPT efficiency	99%		
Night time power consumption	50mW		
<b>Mechanical Data</b>			
Ambient temperature range	-40 °C ~ 65 °C		
Dimensions(W×H×D mm)	212W×190H×40D (Without mounting bracket and cable)		
Weight (kg)	2.8		
Cooling	Natural cooling		
Enclosure environmental rating	IP67		
Protective class	Class I		
<b>Features</b>			
Compatibility	Compatible with 60,72 cell PV modules		
Communication	WiFi / Zigbee		
Compliance	EN50549,VDE0126,VDE4105,IEC62109,CE,INMETRO		
Warranty	10 Years		

# Wiring Diagram

## Sample Wiring Diagram Three Phase

M60G3/80G3/100G3 (2MPPT)

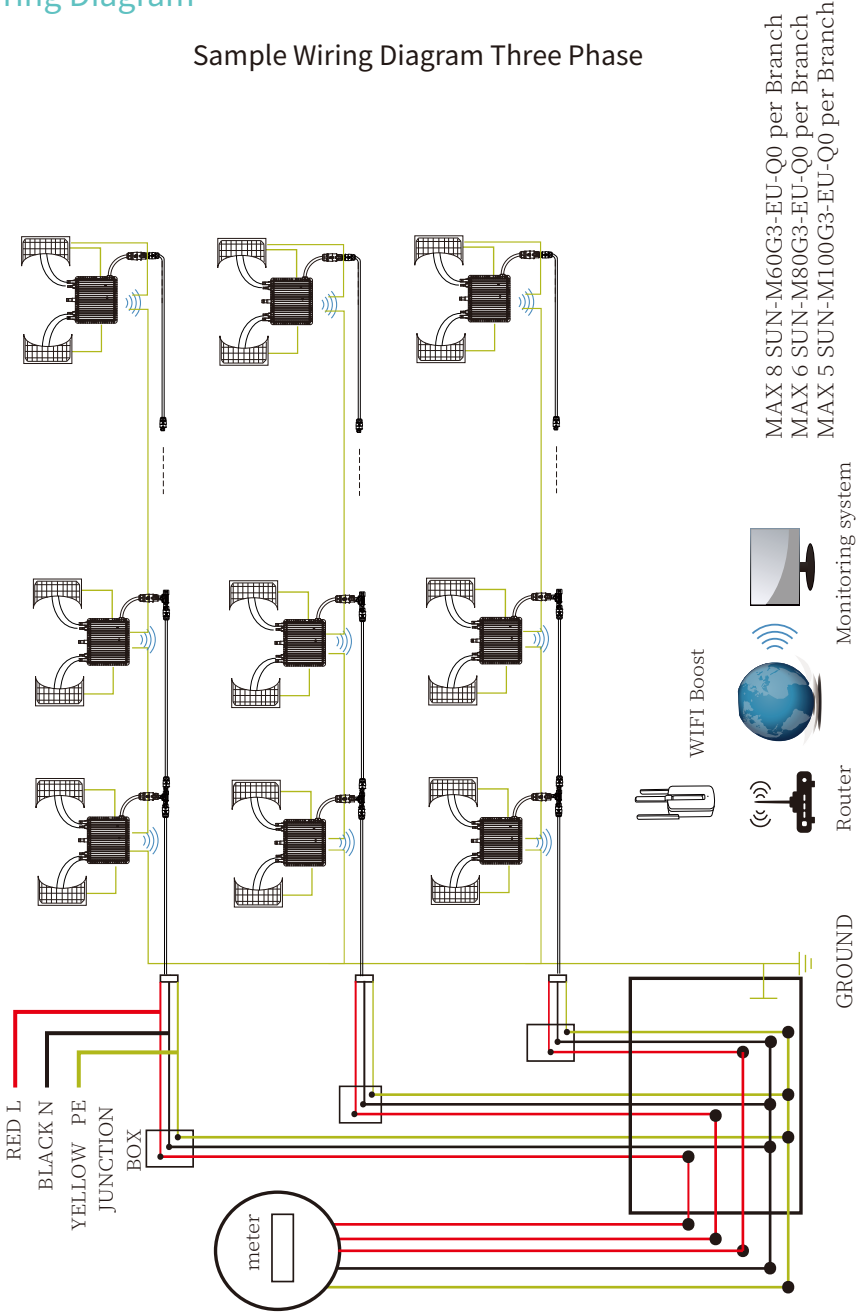

## Sample Wiring Diagram Single Phase

M60G3/80G3/100G3 (2MPPT)

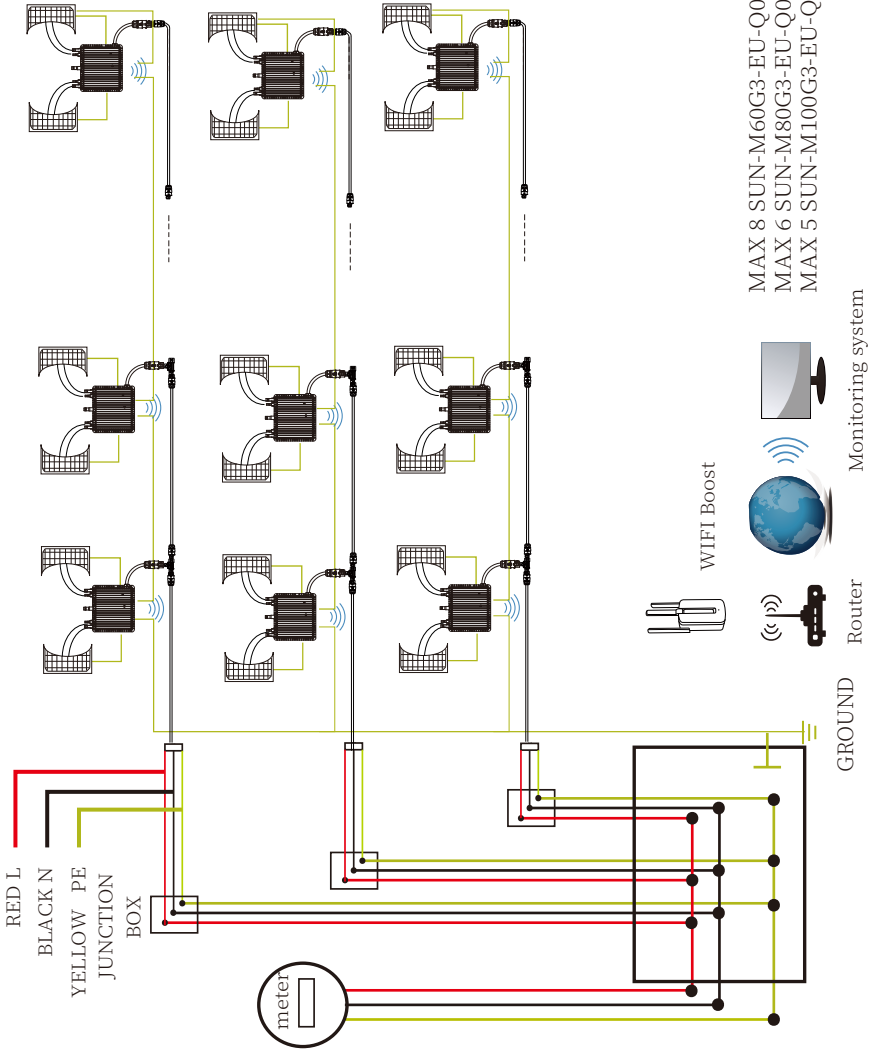

---

---

## Monitoring Platform

This series microinverter has built-in WIFI modular which is able to connect router directly. For WIFI configuration, please check the manual of “Built-in WIFI modular microinverter WIFI configuration Manual”

Web monitoring address: <https://pro.solarmanpv.com>; (for Solarman distributor account)  
<https://home.solarmanpv.com> (for Solarman end user account)

For mobile phone monitoring system, scan the QR code to download the APP.

Also you can find it by searching “solarman business” in App store or Google Play store, and this App is for distributor/installer.

Find it by searching “solarman smart” in App store or Google Play store and choose “solarman smart”, this app is for plant owner.



SOLARMAN Smart  
for end user



SOLARMAN Business  
for distributor/installer

---

---

## How to Configure the Microinverter to the Router Via Web

1. Turn on the wireless network of your PC or smartphone.
2. Select logger network (network name: AP\_SN) and connect. The default password is 12345678.

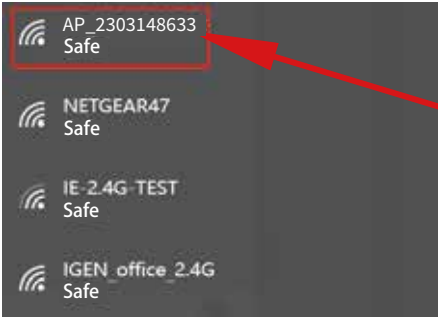

Microinverter SN: 2303148976 Built-in datalogger :2303148633

3. Open a browser and enter 10.10.100.254. Both username and password are "admin". (Recommended browser: IE 8+, Chrome 15+, Firefox 10 + ).

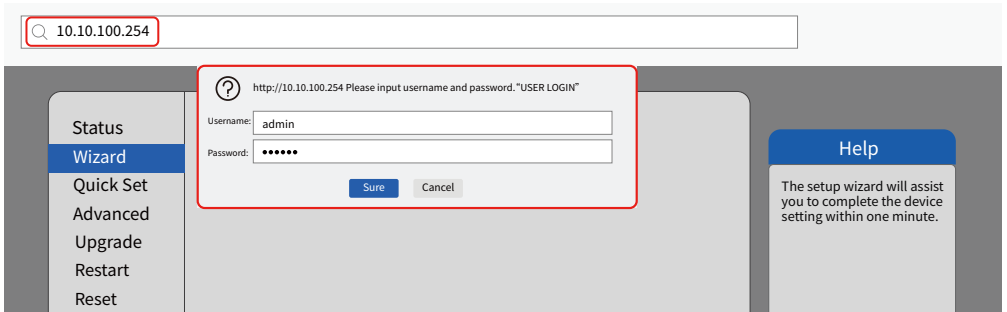

4. Browser jumps to “ Status ” page, the basic information is listed there.

Status		Help																																										
Wizard	<p><b>- Inverter information</b></p> <table border="1"> <tr><td>Inverter serial number</td><td>---</td></tr> <tr><td>Firmware version(main)</td><td>---</td></tr> <tr><td>Firmware version(slave)</td><td>---</td></tr> <tr><td>Inverter model</td><td>---</td></tr> <tr><td>Rated power</td><td>--- W</td></tr> <tr><td>Current power</td><td>--- W</td></tr> <tr><td>Yield today</td><td>---kWh</td></tr> <tr><td>Current power</td><td>---kWh</td></tr> </table> <p><b>- Device information</b></p> <table border="1"> <tr><td>Device serial number</td><td>1704013242</td></tr> <tr><td>Firmware version</td><td>LSW3_14_FFFF_1.0.23</td></tr> <tr><td>Wireless AP mode</td><td>Enable</td></tr> <tr><td>SSID</td><td>AP_1704013242</td></tr> <tr><td>IP address</td><td>10.10.100.254</td></tr> <tr><td>MAC address</td><td>8C:D8:B3:71:8D:B0</td></tr> <tr><td>Wireless STA mode</td><td>Disable</td></tr> <tr><td>Router SSID</td><td></td></tr> <tr><td>Signal Quality</td><td></td></tr> <tr><td>IP address</td><td></td></tr> <tr><td>MAC address</td><td></td></tr> </table> <p><b>- Remote server information</b></p> <table border="1"> <tr><td>Remote server A</td><td>Not connected</td></tr> <tr><td>Remote server B</td><td>Not connected</td></tr> </table>	Inverter serial number	---	Firmware version(main)	---	Firmware version(slave)	---	Inverter model	---	Rated power	--- W	Current power	--- W	Yield today	---kWh	Current power	---kWh	Device serial number	1704013242	Firmware version	LSW3_14_FFFF_1.0.23	Wireless AP mode	Enable	SSID	AP_1704013242	IP address	10.10.100.254	MAC address	8C:D8:B3:71:8D:B0	Wireless STA mode	Disable	Router SSID		Signal Quality		IP address		MAC address		Remote server A	Not connected	Remote server B	Not connected	<p>The device can be used as a wireless access point(AP mode) to facilitate users to configure the device, or it can also be used as a wireless information terminal (STA mode) to connect the remote server via wireless router.</p> <p><b>Status of remote server</b></p> <ul style="list-style-type: none"> <li>• Not connected: Connection to server failed last time. If under such status, please check the issues as follows: (1)check the device information to see whether IP address is obtained or not; (2)check if the router is connected to internet or not; (3)check if a firewall is set on the router or not;</li> <li>• Connected: connection to server successful last time;</li> <li>• Unknown: No connection to server.Please check again in 5 minutes.</li> </ul>
Inverter serial number	---																																											
Firmware version(main)	---																																											
Firmware version(slave)	---																																											
Inverter model	---																																											
Rated power	--- W																																											
Current power	--- W																																											
Yield today	---kWh																																											
Current power	---kWh																																											
Device serial number	1704013242																																											
Firmware version	LSW3_14_FFFF_1.0.23																																											
Wireless AP mode	Enable																																											
SSID	AP_1704013242																																											
IP address	10.10.100.254																																											
MAC address	8C:D8:B3:71:8D:B0																																											
Wireless STA mode	Disable																																											
Router SSID																																												
Signal Quality																																												
IP address																																												
MAC address																																												
Remote server A	Not connected																																											
Remote server B	Not connected																																											

5. Turn to "Wizard" page, click "Refresh" to search the wireless network. Select the target network and click "Next" .

Status		Help																																																
Wizard	<p>Please select your current wireless network:</p> <table border="1"> <tr><td><input checked="" type="radio"/> IE-2.4G-TEST</td><td>54:A7:3:70:99:13</td><td>82</td><td>1</td></tr> <tr><td><input type="radio"/> AP_1753738492</td><td>0:BE:D5:20:B8:2C</td><td>80</td><td>1</td></tr> <tr><td><input type="radio"/> IGEN_office_2.4G</td><td>30:EA:E7:36:B:36</td><td>78</td><td>2</td></tr> <tr><td><input type="radio"/> IGENTEST</td><td>0:BE:D5:20:B8:2C</td><td>76</td><td>1</td></tr> <tr><td><input type="radio"/> IGENTEST</td><td>E8:65:D4:F2:15:68</td><td>74</td><td>6</td></tr> <tr><td><input type="radio"/> IGEN_office_2.4G</td><td>90:5D:7C:97:95:29</td><td>74</td><td>1</td></tr> <tr><td><input type="radio"/> IGEN_office_2.4G</td><td>90:5D:7C:97:95:27</td><td>72</td><td>1</td></tr> <tr><td><input type="radio"/> IGEN_office_2.4G</td><td>90:5D:7C:97:C9:E5</td><td>72</td><td>1</td></tr> <tr><td><input type="radio"/> AP_1719065936</td><td>30:EA:E7:36:CF:B2</td><td>70</td><td>1</td></tr> <tr><td><input type="radio"/> IGEN_office_2.4G</td><td>90:5D:7C:97:C9:E3</td><td>70</td><td>1</td></tr> <tr><td><input type="radio"/> TESR+™ ?=, ;</td><td>4A:E:EC:9E:C3:3E</td><td>70</td><td>11</td></tr> <tr><td><input type="radio"/> IGEN_office_2.4G</td><td>0:BE:D5:20:B7:EE</td><td>66</td><td>11</td></tr> </table> <p>* Note: When RSSI of the selected WiFi network is lower than 15%, the connection may be unstable, please select other available network or shorten the distance between the device and router.</p> <p>Refresh</p> <p>Add wireless network manually:</p> <p>Network name (SSID) (Note:case sensitive) <input type="text" value="IE-2.4G-TEST"/></p> <p>Encryption method <input type="text" value="WPA2PSK"/></p> <p>Encryption algorithm <input type="text" value="AES"/></p> <p>Next</p> <p>1 2 3 4</p>	<input checked="" type="radio"/> IE-2.4G-TEST	54:A7:3:70:99:13	82	1	<input type="radio"/> AP_1753738492	0:BE:D5:20:B8:2C	80	1	<input type="radio"/> IGEN_office_2.4G	30:EA:E7:36:B:36	78	2	<input type="radio"/> IGENTEST	0:BE:D5:20:B8:2C	76	1	<input type="radio"/> IGENTEST	E8:65:D4:F2:15:68	74	6	<input type="radio"/> IGEN_office_2.4G	90:5D:7C:97:95:29	74	1	<input type="radio"/> IGEN_office_2.4G	90:5D:7C:97:95:27	72	1	<input type="radio"/> IGEN_office_2.4G	90:5D:7C:97:C9:E5	72	1	<input type="radio"/> AP_1719065936	30:EA:E7:36:CF:B2	70	1	<input type="radio"/> IGEN_office_2.4G	90:5D:7C:97:C9:E3	70	1	<input type="radio"/> TESR+™ ?=, ;	4A:E:EC:9E:C3:3E	70	11	<input type="radio"/> IGEN_office_2.4G	0:BE:D5:20:B7:EE	66	11	<p>The setup wizard will assist you to complete the device setting within one minute.</p>
<input checked="" type="radio"/> IE-2.4G-TEST	54:A7:3:70:99:13	82	1																																															
<input type="radio"/> AP_1753738492	0:BE:D5:20:B8:2C	80	1																																															
<input type="radio"/> IGEN_office_2.4G	30:EA:E7:36:B:36	78	2																																															
<input type="radio"/> IGENTEST	0:BE:D5:20:B8:2C	76	1																																															
<input type="radio"/> IGENTEST	E8:65:D4:F2:15:68	74	6																																															
<input type="radio"/> IGEN_office_2.4G	90:5D:7C:97:95:29	74	1																																															
<input type="radio"/> IGEN_office_2.4G	90:5D:7C:97:95:27	72	1																																															
<input type="radio"/> IGEN_office_2.4G	90:5D:7C:97:C9:E5	72	1																																															
<input type="radio"/> AP_1719065936	30:EA:E7:36:CF:B2	70	1																																															
<input type="radio"/> IGEN_office_2.4G	90:5D:7C:97:C9:E3	70	1																																															
<input type="radio"/> TESR+™ ?=, ;	4A:E:EC:9E:C3:3E	70	11																																															
<input type="radio"/> IGEN_office_2.4G	0:BE:D5:20:B7:EE	66	11																																															

6. Enter the password and click Next.

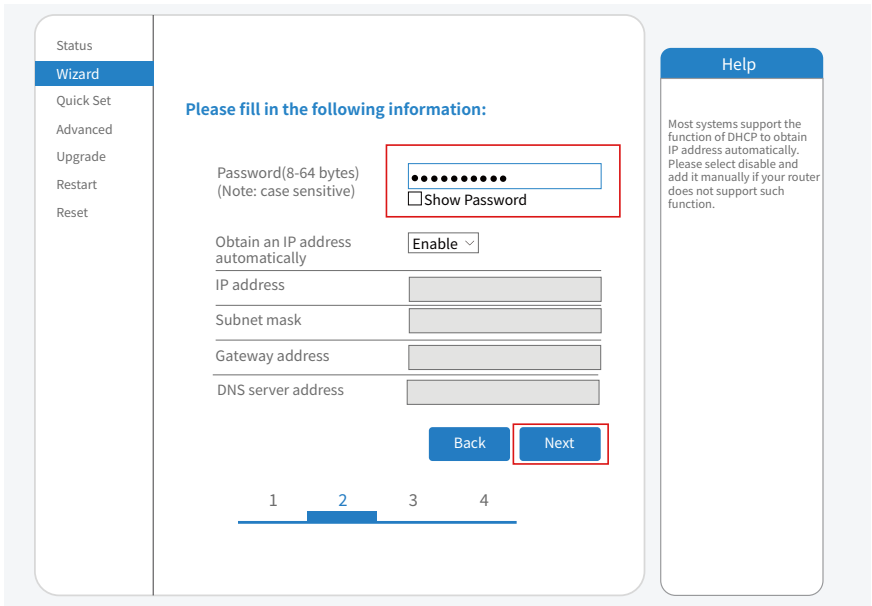

7. Users can select any options below to enhance the security and click Next.

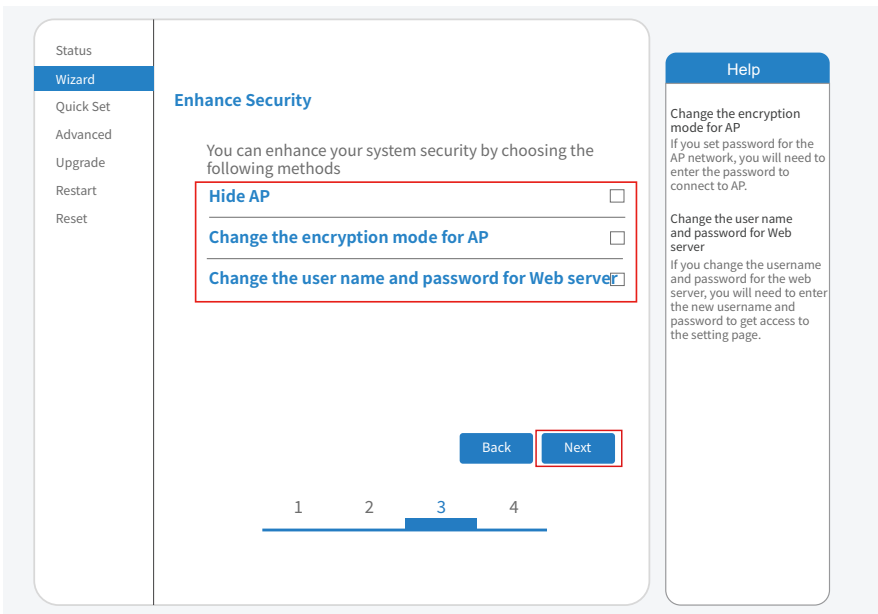

8. If the setup is successful, the following page will pop up and click OK to reboot the micro inverter.



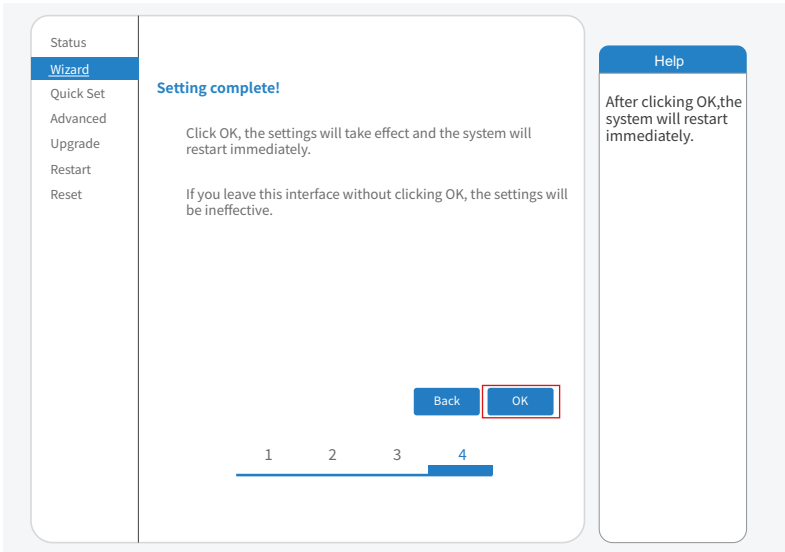

9. Connect to logger AP network again, then log in to 10.10.100.254 by Browser, and check the system info of "Status" page. After the network setting is done, the remote server A or B should be "connected".

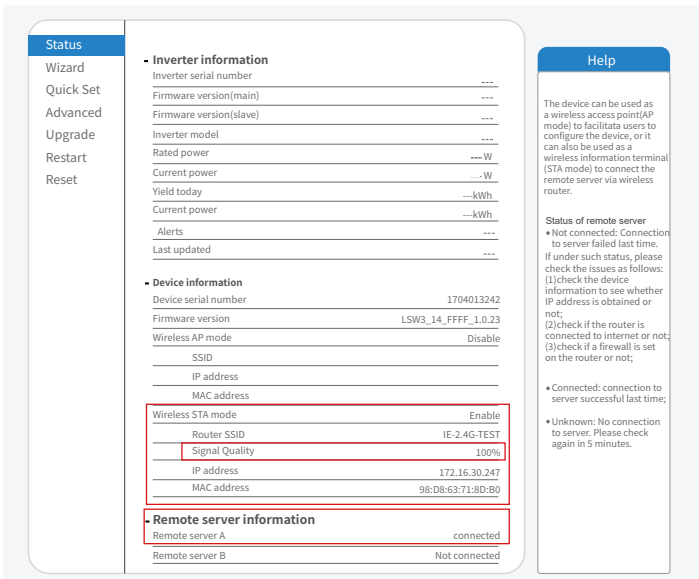

10. When it shows "connected" which means this microinverter has connected solarman platform successfully. Generally speaking, it will be online after 10-15min after configuration successfully at the first time.

# How to connect in APP

## 1. Registration

Open the app of SOLARMAN Smart and register an account.  
Click "Register" and create your account here.

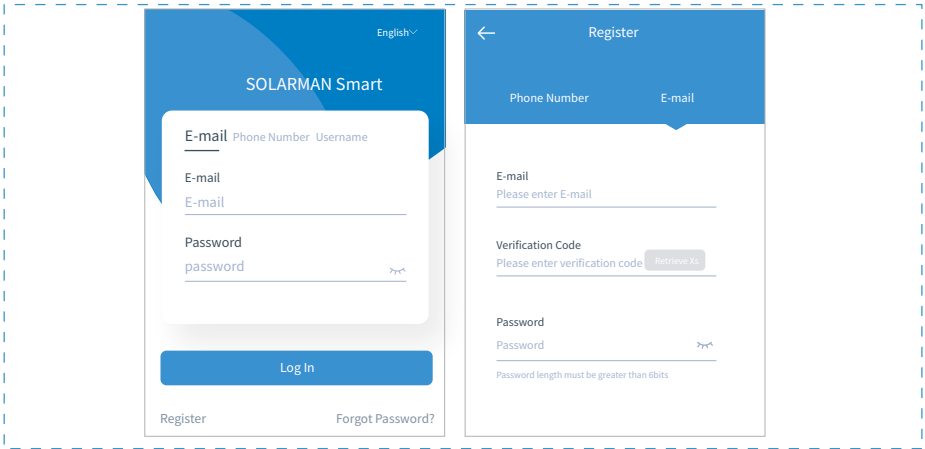

## 2. Create a Plant

Click "Add Now" to create your plant.  
Please fill in plant basic info and other info here.

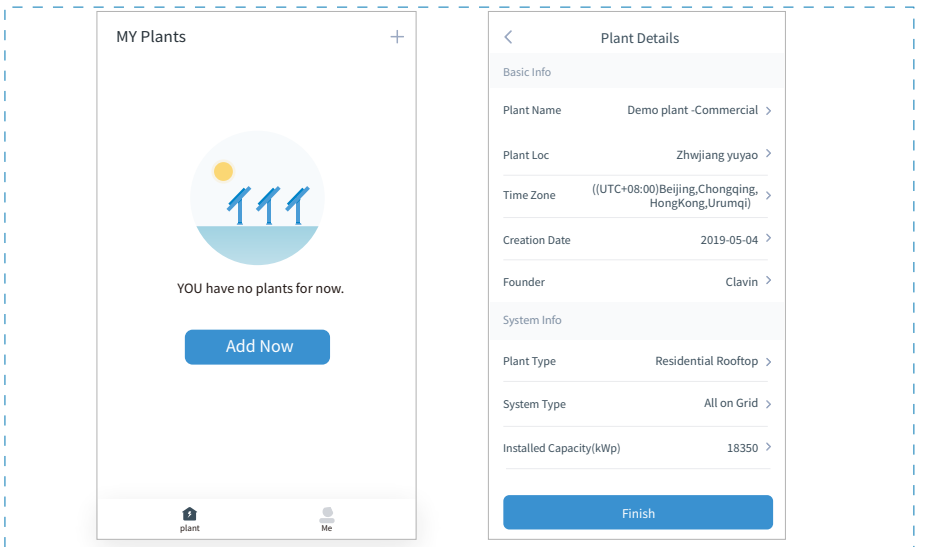

### 3. Add a Logger

Optional 1: Enter the logger SN manually.

Optional 2: Click the icon in the right and scan the QR code to enter logger SN.

You can find logger SN on the carton packaging or on the logger body.

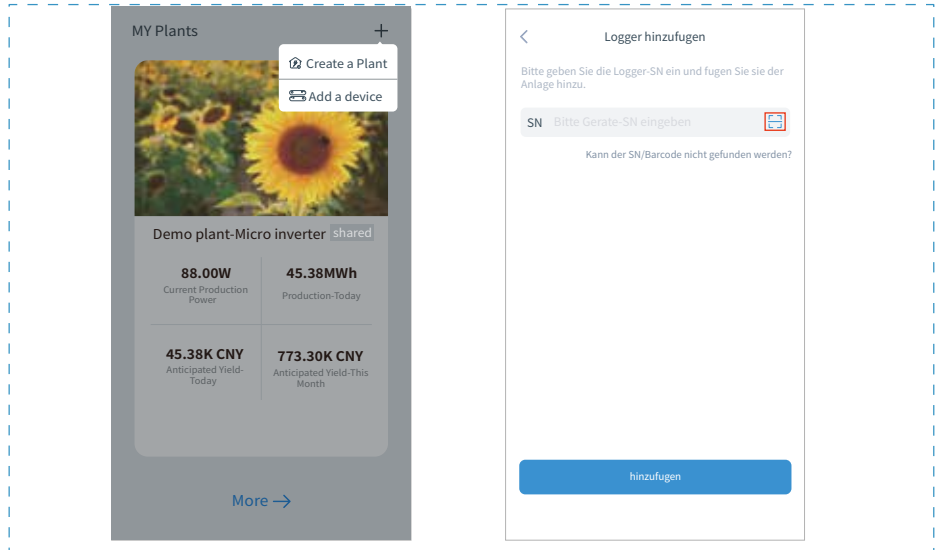

### 4. Network Configuration

After the logger is added, please configure the network to ensure normal operation.

Go to "Plant Details"->"Device List", find the target SN and click " Device Networking".

If showing "online" which means the datalogger of the inverter connects the solarman platform successfully. Then you will be able to check the plant info on the platform.

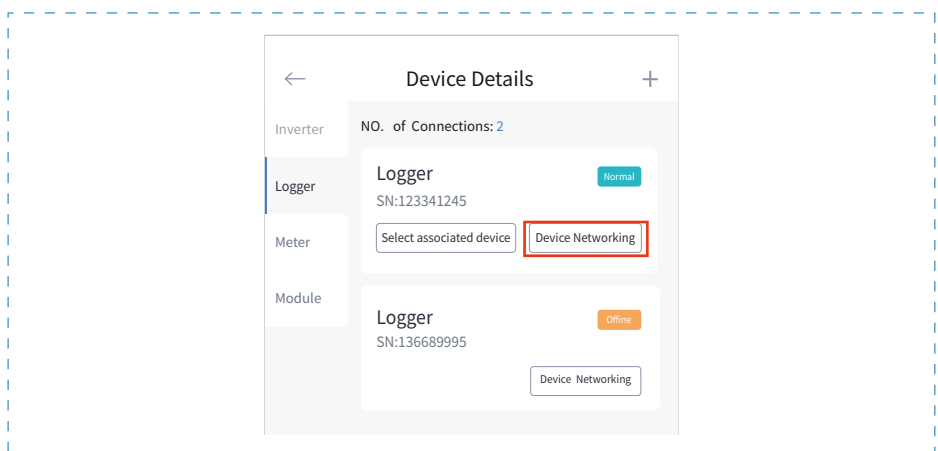



30240301001859