



DBU100 Series

Braking Unit Product Manual

SHENZHEN DIRISE ELECTRIC TECHNOLOGY CO.,LTD
DONGGUAN DIRISE ELECTRIC EQUIPMENT MANUFACTURING CO.,LTD

Introduction

Thank you for choosing the Dirise DBU100 series brake unit.

DBU100 series brake unit adopts the modular design concept, using the latest 16 bit CPU for full digital control, real-time monitoring of busbar voltage, real-time adjustment of brake torque by using the large capacity IGBT and increasing of radiator, to reduce the failure rate at the same time, more can effectively improve the overload capacity. And to provide the external normally open, normally closed two overheating alarm signal output. Can provide perfect solution for industry application demand.

This manual provides some precautions for product installation and wiring parameter setting and fault diagnosis. To ensure that the DBU100 series brake unit can be installed and operated correctly and exert its superior performance, please read this manual in detail before installing the machine. This manual is an attachment sent randomly. Please attach it to the user of the machine and keep it properly.

Though we have examined the consistency of content with software and hardware during review, there may still be some contradictories and mistakes, which will be revised in future versions. Should there be any information changed in the future, we won't provide extra notices. We sincerely welcome any suggestions for improvement.

Contents

Introduction	1
Contents	2
Out of Box Audit(OBA)	3
Chapter 1 Safety Precautions	4
1.1 installation	4
1.2 Wiring	4
1.3 Operation	4
1.4 Maintenance	5
1.5 Disposal	5
1.6 Applicable scale of product	5
Chapter 2 Product information	6
2.1 Product model description	6
2.2 Nameplate description	6
2.3 DBU100 Brake unit product series	7
2.4 Technical specification	8
2.5 Product installation size	8
Chapter 3 Product installation guide	10
3.1 Installation method of brake unit	10
3.2 DBU100 Series brake unit terminal specification	11
3.3 Main circuit wiring method	12
3.4 DBU100 Brake unit main circuit wiring specification	13
Chapter 4 operation voltage setting	15
Chapter 5 status indication	16
Chapter 6 selection of brake unit	16
Chapter 7 common faults and simple maintenance methods	16
Chapter 8 quality commitment	18

Out of Box Audit (OOBA)

Before the product manufacture and package, our company has made a serious QC inspection .If any miss is found ,please make a contact with us, branch office or distributor as soon as possible .We will devote to constant optimizing and improving our product. If it is necessary to make any required modification, we will update the manual or provide corrigenda without extra notice.

Please check the following items when arrival:

- * Whether the product package is damaged**
 - * Read the data on nameplate to confirm the type and specification of product are in accordance with your order.**
 - *Check the period of inventory**
- If you have any questions, please contact Dirise or the supplier.**

Chapter 1 Safety Precautions

You must carefully read the following contents before installation, wiring, operation and maintenance of the product, and operate strictly according to notes.

1.1 Installation



- Please install the brake unit on a nonflammable metal, lest there may be a risk of fire.
- Must not install the brake unit in the environment containing combustibles or explosive gases. otherwise, there may be a risk of explosion.



- Install the brake unit on a strong and reliable object which can stand the weight of brake unit. otherwise, there may be a risk of fall or damage.
- Prevent any metal object from falling inside the brake unit, otherwise, there may be a risk of accident.
- Do not try to install or run a damaged brake unit, otherwise, there may be a risk of accident.

1.2 Wiring



- Wiring must be done by someone with professional qualifications, otherwise there is a risk of electric shock.
- During installation and wiring, the brake unit and other equipment connected to it, such as frequency inverter, must be disconnected to ensure safety.
- The grounding terminal of the braking device must be grounded reliably, or there is a risk of electric shock.



- The positive and negative terminals of the dc bus of the braking device cannot be connected in reverse, otherwise, they will not work and even cause damage to the braking device itself and related equipment, and there is a fire hazard.
- The braking device should be installed in a place with good ventilation, otherwise it may cause the equipment to not work properly or even damage.

1.3 Operation



- After electrification, the brake device internal components with dangerous high voltage, if the human body direct contact will be extremely dangerous, even life-threatening.



- Ensure that the mask cover is properly closed during use.

1.4 Maintenance



- During maintenance, the braking unit and the equipment connected to it must be cut off for 10 minutes before the braking unit can be checked and repaired, otherwise electric shock may occur.
- Only trained personnel are allowed to maintain the brake unit, otherwise electric shock or personal injury may occur Injury accident.



- Do not leave conductive objects such as metal inside the brake unit after repair, otherwise damage may be caused.

1.5 Disposal



- When the product is discarded, dispose it as an industrial waste. Otherwise, accident may occur.

1.6 Applicable scope of product



- Not applicable to machines or systems that may put a person's life at risk.
- If it is expected that there will be a major accident or loss due to the abnormal product, please be sure to install safety devices.

Chapter 2 Product Information

2.1 Product model description

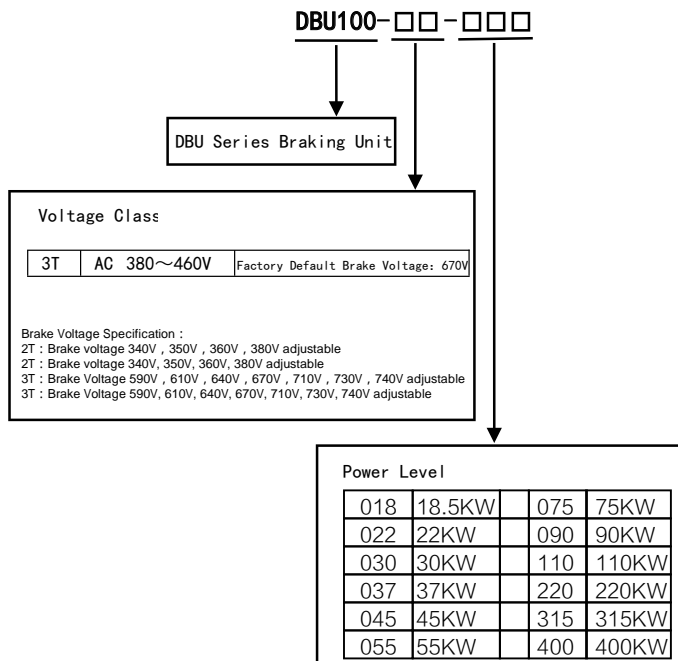

Figure 2.1 brake unit model description

2.2 Product nameplate description

Below the right panel of the brake unit case, There is a nameplate marking the model and rating of the braking unit, the content of nameplate is shown in figure 2-2.

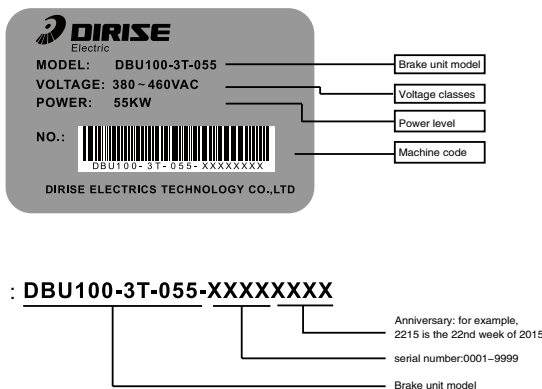

Figure 2.2 brake unit nameplate

2.3 DBU100 Brake unit product series

Table 2.1 DBU100-18.5KW~90KW braking unit specification table

Voltage classes	Motor power	Model number	Rated current (160% torque)	Maximum current	Braking resistance (error $\pm 5\%$)
380V	18.5KW	DBU100-3T-018	30A	49A	23.6 Ω /7.4KW
	22KW	DBU100-3T-022	35A	58A	19.9 Ω /8.8KW
	30KW	DBU100-3T-030	48A	80A	14.6 Ω /12.0KW
	37KW	DBU100-3T-037	59A	98A	11.8 Ω /14.8KW
	45KW	DBU100-3T-045	72A	120A	9.7 Ω /18.0KW
	55KW	DBU100-3T-055	88A	146A	8.0 Ω /22.0KW
	75KW	DBU100-3T-075	120A	199A	5.8 Ω /30.0KW
	90KW	DBU100-3T-090	144A	239A	4.9 Ω /36.0KW

Table 2.2 DBU100-110KW~400KW braking unit specification table

Voltage classes	Motor power	Model number	Rated current (160% torque)	Maximum current	Braking resistance (error $\pm 5\%$)
380V	75KW	DBU100-3T-110	70A	150A	7.5 Ω /20.0KW
	110KW	DBU100-3T-220	85A	200A	5.1 Ω /30.8KW
	220KW	DBU100-3T-315	120A	300A	3.0 Ω /60.0KW
	280KW	DBU100-3T-400	160A	400A	2.4 Ω /90.0KW

2.4 Product technical specifications

Table 2.1 DBU100 series brake unit technical specification

Items		Specification
Power source	Network voltage	Three phase 220VAC/380VAC/460VAC, allowable voltage fluctuation range $\pm 15\%$
	Power frequency	45Hz ~ 65Hz
Control mode	Brake mode	Dynamic voltage tracking mode
	Response time	$\leq 1\text{ms}$
	Operation voltage	340V, 350V, 360V, 380V, 590V, 610V, 640V, 670V, 710V, 730V, 740Va total of 11 files (according to actual working condition, can be set freely)
	Hysteresis voltage	$\leq 10\text{V}$
	Protection function	Overheat protection
	Overheat protection	75°C (normally closed contact NC-CM changes from normally closed to normally open output, and normally open contact NC-CM changes from normally open to normally closed output)
Display and Settings	Indicator light	Power indicator, red; Running indicator light, green; Fault indicator light, red;
	Operation monitoring and controlling	1、When setting 340 ~ 380V, the actual voltage is $\geq 500\text{DC}$, the braking unit stops working, and the fault light is on. 2、When 590 ~ 740V is set, the actual voltage is $\geq 900\text{DC}$, the braking unit stops working, and the fault light is on. 3、When there are 2 or more choices (at the same time), the fault light is on. 4、When the braking voltage is not selected, the braking unit does not work and the fault light is on. 5、When the dc bus voltage exceeds the selected brake threshold voltage, the brake unit works and the operating indicator lamp flashes at a frequency of 0.2 seconds. For example, the selected brake threshold voltage is 640V. When the dc bus voltage is greater than 640V, the brake unit works and the operating indicator flashes at a frequency of 0.2 seconds.
	Operating voltage setting	Set up by the manufacturer according to customer requirements.
Installation environment	Place of installation	Indoor, the elevation is not more than 1000 meters (For every 1000 meters increased, the amount must be reduced by 10%), no direct sunlight, no conductive dust and corrosive gas.
	Environmental temperature	-10 ~ +45°C, well ventilated
	Ambient humidity	Below 90%RH (no condensation)
	Vibrational degrees	< 0.5g

2.5 Product installation size

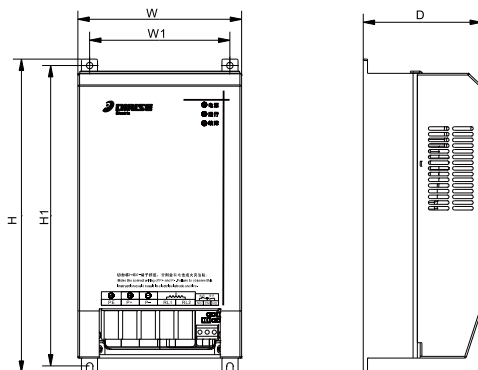

Figure 2.3 A Box

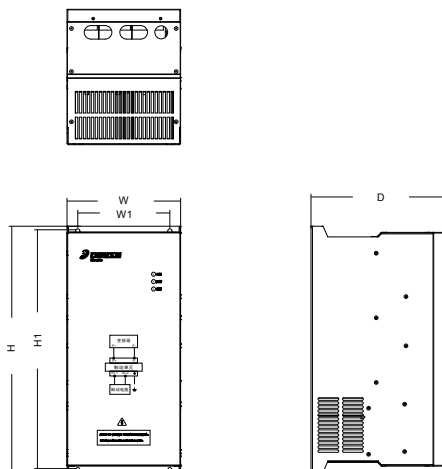

Figure 2.4 B Box

Table 2.4 DBU100 series brake unit installation dimensions

Installation dimension	H	H1	W	W1	D	Diameter of mounting recess	Power level
A cabinet	220mm	212mm	110mm	99mm	83mm	4.5mm	18.5KW ~ 55KW
B cabinet	400mm	390mm	185mm	150mm	220mm	6.5mm	110KW ~ 400KW

Chapter 3 Product installation guide

3.1 Installation method of brake unit

3.1.1 Installation of brake unit

The braking unit shall be mounted vertically on a non-flammable solid fixed surface. Because the brake unit itself will produce heat generation, therefore, users in the installation must consider ventilation, heat dissipation and personal safety, there is enough space around the braking unit. The minimum ventilation space is width of 10cm and height of 8cm.

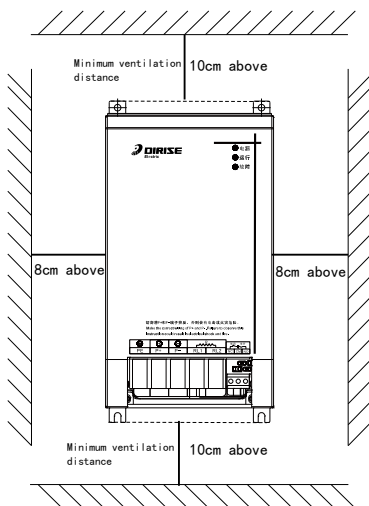

FIG. 3.1 Installation diagram of DBU100 series brake units



● The brake unit must be installed in a well-ventilated place. If the unit is to be installed in the cabinet, the cabinet must be left with a suitable cooling hole, if necessary in the appropriate location of the cabinet to install exhaust fan to ensure good heat dissipation.

3.1.2 Connection diagram of brake unit with inverter and brake resistance

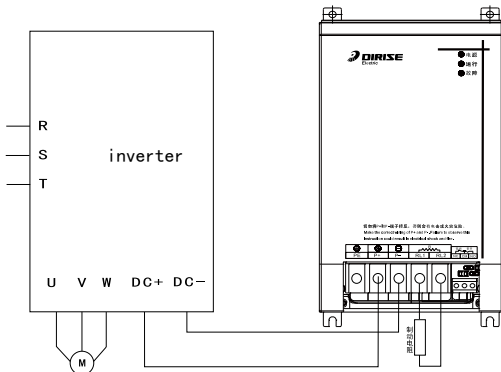

Figure 3.2 DBU100 series brake unit and inverter, brake resistance wiring diagram



● Work with the brake unit with the brake resistance will produce high heat, so must be installed in a separate cabinet, not with the inverter brake unit and other equipment installed together. Improper installation position of brake resistance may cause abnormal or even damage to other equipment.

● Brake resistors should not be placed near inflammable and explosive objects.

3.2 DBU100 series brake unit terminals

3.2.1 DBU100 series brake unit terminal permutation

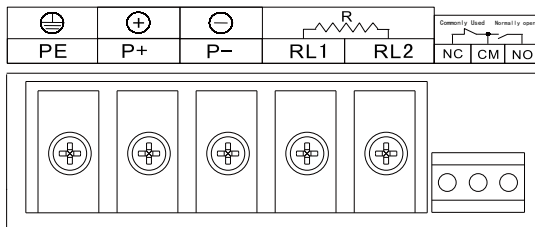

Figure 3.3 Terminal arrangement of DBU100 Series Brake unit 18.5KW ~ 90KW

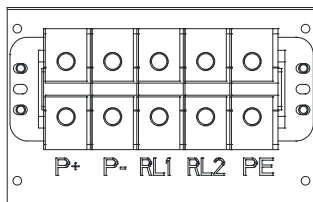

Figure 3.4 Terminal arrangement of DBU100 Series Brake unit (110KW ~ 400KW)

3.2.2 DBU100 Series brake unit terminal function description

Table 3.1 DBU100 series brake unit power terminal function description

Terminal label	Function description
PE	Grounding terminal of brake unit
P+	Dc bus positive input terminal
P-	Dc bus negative input terminal
RL1, RL2	Brake resistance wiring terminal

Table 3.2 DBU100 series brake unit overheating alarm terminal function description

Terminal label	Function description
NC	Normally closed contact of relay
CM	Relay common point
NO	Normally open contact of relay

3.3 Main circuit wiring method

3.3.1 Power input terminal

P+ and P- are the positive and negative input terminals of the dc bus of the braking unit, which should be connected with the positive and negative terminals of the dc bus of the inverter.

When the inverter needs to connect the dc reactor, the positive pole access point of the brake unit dc bus should be behind the linear reactor. The connection distance between inverter dc bus and brake unit should be as short as possible.

3.3.2 Brake resistance, fault protection and grounding terminal

RL1 and RL2 are the wiring terminals of the braking resistance, and the resistance value and power of the braking resistance shall be correctly selected and matched when correctly connected to the braking resistance.

NC-CM, NO-CM is the internal fault protection dry contact output. fault protection contact action, NO-CM is normally open contact NC-CM is normally closed contact, users can use according to the actual working

conditions. When the brake unit internal overheating and other faults (75°C), the internal contact action. This dry contact can be used with the external control circuit for alarm and PLC status display.

3.3.3 Identification of dc bus terminal of inverter.

When DBU100 series brake unit is used with inverter, dc input terminals P+ and P- of brake unit must be correctly connected to positive and negative terminals of DC bus of inverter. However, in many cases, because the inverter has more than one main loop connection terminal related to the DC bus, it will be difficult to correctly identify the DC bus terminal of the inverter. Figure 3.5 shows some wiring terminals usually provided by the inverter.

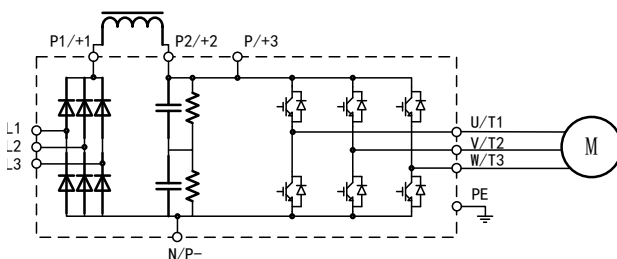

Figure 3.5 Common frequency inverter wiring terminals



In Figure 3.5, P1, P2, P and N are related to the DC bus. Among them, terminal N is the wiring terminal of the dc bus negative pole, which is easy to identify. When wiring, this terminal should be connected with the P- of the brake unit.

P1 and P2 are the terminals of the external DC reactor. Usually, when the inverter leaves the factory, because there is no external DC reactor, these two terminals are connected with a short circuit copper bar.

P is the external terminal of the energy consumption braking unit and the positive terminal of the DC bus. When wiring, the P+ terminal of the brake unit should be connected with the P terminal in the figure.



● Depending on the frequency inverter manufacturer and the power level, the actual number of terminals provided by the frequency inverter may differ from that indicated in the figure. At this point, read the instruction of the inverter carefully to find out the dc bus terminal of

the inverter correctly.

● The external DC reactor terminals "P1" and "P2" in the figure are sometimes labeled as "+1" and "+2". Some low-power inverters do not provide terminals for external DC reactors. Terminals "P2" and "P" may also be combined into a unified DC bus positive terminal. Usually, this terminal is sometimes labeled "P+", "+", etc. The dc bus negative connection terminal of frequency inverter is sometimes marked as "N", "-", and so on. Please read the actual frequency inverter manual for yourself.

3.4 DBU100 Brake unit main circuit wiring specification

Table 3.3 main loop cable specifications of DBU100 series brake units

Voltage classes	Motor power	Product model	Rated current (160% torque)	Connection cable specification
380V	18.5KW	DBU100-3T-018	30A	4mm ²
	22KW	DBU100-3T-022	35A	4mm ²
	30KW	DBU100-3T-030	48A	6mm ²
	37KW	DBU100-3T-037	59A	10mm ²
	45KW	DBU100-3T-045	72A	10mm ²
	55KW	DBU100-3T-055	88A	16mm ²
	75KW	DBU100-3T-075	120A	25mm ²
	90KW	DBU100-3T-090	144A	25mm ²

Table 3.4 Main loop cable specifications of DBU100 series brake units

Voltage classes	Motor power	Product model	Rated current (160% torque)	Connection cable specification
380V	75KW	DBU100-3T-110	70A	16mm ²
	110KW	DBU100-3T-220	85A	16mm ²
	220KW	DBU100-3T-315	120A	25mm ²
	280KW	DBU100-3T-400	160A	35mm ²



● Flexible cables have better flexibility because cables may come into contact with high-temperature equipment. Copper cores, heat resistant, flexible cables or flame retardant cables are recommended.



● The distance between the brake unit and the inverter should be as close as possible, preferably no more than 1 meter, otherwise the dc side cable should be twisted together to reduce radiation and inductance.

Chapter 4 Operation voltage setting

(FIG. 4.1) DBU100 series 18.5KW~90KW brake unit brake valve voltage is 340V, 350V, 360V, 380V, 590V, 610V, 640V, 670V, 710V, 730V, 740V eleven tap positions. (FIG. 4.2) DBU100 series 110KW~400KW brake unit has a brake threshold voltage of 580V, 610V, 640V, 670V, 700V and 730V six tap positions. The user needs to determine the operating voltage of the DBU100 braking unit according to the actual working condition. A professional person loosens the upper cover of the braking unit with a screwdriver and sets the threshold voltage according to Figure 4.1.

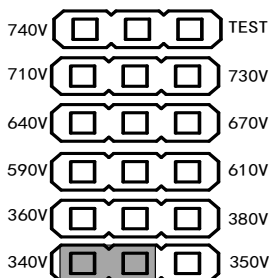

Set the brake voltage threshold to 340V

Figure 4.1 DBU100 series 18.5KW~90KW brake unit action threshold voltage setting diagram

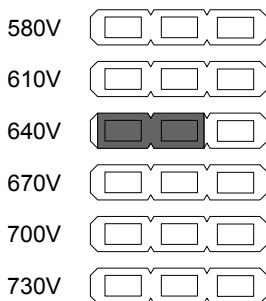

Set the brake voltage threshold to 640V

Figure 4.2 DBU100 Series 110KW~400KW brake unit action threshold voltage setting diagram





● When setting the threshold voltage of DBU100 series brake unit, the professional should first carry out electrostatic protection.

Chapter 5 Status indication

The indicating area of the DBU100 series brake unit is composed of three luminous indicators, each of which has a corresponding meaning when lit, as shown in table 5.1.

Table 5.1 State of DBU100 indicator light

Power led	Power led status	Description of power indicator status
 Power source	power on	Indicates that the power supply of the brake unit is normal.
	no power	It indicates that the power supply of the brake unit is abnormal.
 Operation	Power light flashing	Blink at a frequency of 0.2 seconds, indicating that the braking unit is currently in the braking working state.
	no power	Indicates that the braking unit is currently in standby state.
 Fault	power on	Indicates that the brake unit is in a faulty state.
	no power	Indicates that the braking unit is currently in standby state.

Chapter 6 Selection of brake unit

The braking unit is an electronic equipment designed according to the intermittent working time. Its ability to work for a long time in large current is limited. Therefore, it must be selected reasonably to ensure that the braking unit will not be damaged by excessive current and overheating.

The selection of brake unit is based on its rated current and peak current. The rated current is proportional to the current that the braking unit can operate continuously for a long time, and the peak current represents the maximum current that the braking unit can pass. To ensure the normal operation of the braking unit, it must be ensured that the maximum current flowing through the braking unit is less than its peak current and that the product of the maximum current and the braking frequency K_c is less than its rated current.

Chapter 7 Common faults and simple maintenance methods

Simple test method

After the DBU100 series brake units are unloaded, the diode of the digital multimeter, the red and black digraphs are connected to the four terminals of P+, P-, RL1 and RL2 respectively to simply test the braking units. The measured results should be shown in table 7.1:

Table 7.1 DBU100 series Brake unit simple test method

Testing terminal	Testing method
P+, P-	Red stylus contact P+, black stylus contact P-, the normal test results should be: pressure drop from zero gradually increased, and finally stabilized at infinity.
	Red stylus contact P-, black stylus contact P+, normal test results should be: pressure drop between 300-800mV
RL1, RL2	Red stylus contact RL1, black stylus contact RL2, normal test results should be: pressure drop from zero gradually increased to infinity
	Red stylus contact RL2, black stylus contact RL1, normal test results should be: pressure drop between 200-500mV

Note: This test method is only used to test the quality of the module, not including the whole machine test.

Table 7.2 List of common faults of DBU100 series brake units

Serial number	Common fault	Analysis of causes	Elimination methods
1	There is a braking noise (squeak), but the inverter still has an overvoltage	Excessive brake resistance	inverter deceleration time is too short, extend the inverter deceleration time
		Braking unit capacity is insufficient	Recalculate the braking resistance parameters and select the braking unit
			Recalculate brake unit specification
2	No braking sound	Incorrect selection of brake unit or mismatching of working voltage	Recalculate brake unit specification
		The resistance is broken or the cable is not connected, the brake is invalid	Check brake resistance and connection cable
		Resistance short circuit, brake automatic stop output	Replace brake resistance
		Brake unit fault	Contact the supplier, repair and replace brake unit
3	The brake resistance is too hot	The selected brake resistance is too low	Increase the braking resistance power

4	When the inverter is not working, the resistance is still hot	Incorrect selection of brake unit or mismatching of working voltage	Reselect the brake sheet
		The field grid voltage fluctuates too much, exceeding the action voltage of the braking unit	Suppress grid voltage fluctuation, or reset brake operating voltage
		Wrong setting of brake unit action voltage	Reset brake operating voltage
5	The inverter is protected by overcurrent when braking	Braking resistance value	Recalculate the type of brake resistance, or extend the inverter deceleration time
		Excessive braking torque	The system is not designed correctly and needs to be redesigned
6	The inverter can't power	Wrong direction of positive and negative terminal of brake unit input wiring	Check the wiring for rewiring
7	Overheat of brake unit	Ventilation is not good	reinstallation
		The braking frequency of the system is too high	Recalculating design

Chapter 8 Quality commitment

The quality assurance of this product shall be subject to the following terms and conditions:

From the date of purchase of the product, due to product quality problems, users can enjoy the following three guarantees of service:

▲ Guarantee return, replacement and repair within 1 month after shipment;

▲ Replacement and repair within 3 months after shipment;

▲ Repair within 12 months after shipment;

▲ When exporting abroad, repair is guaranteed within 3 months after arrival of the goods.

No matter where you buy the company's products, you will enjoy a lifetime of paid services;

Failure caused by the following reasons, even if the product is in the warranty period, is a paid service:

▲ Failure to use and operate in accordance with the requirements of the product manual;

▲ Failure caused by unauthorized modification or out-of-range use;

▲ Not paying off the goods as contracted;

▲ Faults caused by natural disasters such as earthquake, fire, flood, lightning strike or abnormal voltage;

For the services of guaranteed return, replacement and repair, the customer shall return the products to the company. After the ownership of the responsibility is confirmed, May be returned or repaired.



SHENZHEN DIRISE ELECTRIC TECHNOLOGY CO., LTD

R &D Center : Room 0411, Building 6, Skyworth Innovation Valley,
Baoan District, Shenzhen.

Shenzhen switchboard: 0755-2605 2805

Http: <http://www.dirise.cn>

DONGGUAN DIRISE ELECTRIC EQUIPMENT MANUFACTURING CO.,LTD

production base : No.11 SangYuan Road,ChenWu Village,HouJie Town,
DongGuan City

Dongguan switchboard: 0769-8588 7800

Http: <http://www.dirise.cn>
