



## Solis S5-EH1P-L Hybrid Inverter Instruction Manual

Ver 1.3

Ginlong Technologies Co., Ltd.

No. 57 Jintong Road, Binhai Industrial Park, Xiangshan, Ningbo,  
Zhejiang, 315712, P.R.China.

Tel: +86 (0)574 6578 1806

Fax: +86 (0)574 6578 1606

Email: info@ginlong.com

Web: www.ginlong.com

Please adhere to the actual products in case of any discrepancies in this user manual.

If you encounter any problem on the inverter, please find out the inverter S/N  
and contact us, we will try to respond to your question ASAP.



UK  
CA UK mark for conformity

Ginlong Technologies Co., Ltd.

---

<b>1. Introduction</b>	01
1.1 Product Description	01
1.2 Packaging	02
<b>2. Safety &amp; Warning</b>	03
2.1 Safety	03
2.2 General Safety Instructions	03
2.3 Notice For Use	05
<b>3. Overview</b>	06
3.1 Screen	06
3.2 Keypad	06
3.3 LED Indicators	06
<b>4. Installation</b>	07
4.1 Select a Location for the Inverter	07
4.2 Mounting the Inverter	09
4.3 PE Cable Installation	11
4.4 PV Input Cable Installation	12
4.5 Battery Power Cable Installation	15
4.6 AC Cable Installation	20
4.7 Communication Cable Installation	22
4.8 Meter Installation	27
4.9 Max. over current protect protection device(OCPD)	33
<b>5. Commissioning &amp; Shutdown</b>	34
5.1 Preparation of Commissioning	34
5.2 Commissioning Procedure	34
5.3 Shutdown procedure	42
<b>6. Operation</b>	43
6.1 Initial Display	43
6.2 Main Menu	45
6.3 Information	45
6.4 Settings	48
6.5 Advanced Info	50
6.6 Advanced Settings - Technicians Only	55
<b>7. Maintenance</b>	79
<b>8. Troubleshooting</b>	80
<b>9. Specifications</b>	86

# 1. Introduction

## 1.1 Product Description

The Solis S5-EH1P-L Series is designed for residential hybrid systems, which can work with batteries to optimize self-consumption. The unit can operate in both off-grid and on-grid modes.

This manual covers the Solis S5-EH1P-L Series model listed below:

S5-EH1P3K-L, S5-EH1P3.6K-L, S5-EH1P4.6K-L, S5-EH1P5K-L, S5-EH1P6K-L

The following models are designed for the Belgian market:

S5-EH1P3K-L-BE, S5-EH1P3.6K-BE, S5-EH1P4.6K-BE, S5-EH1P5K-BE

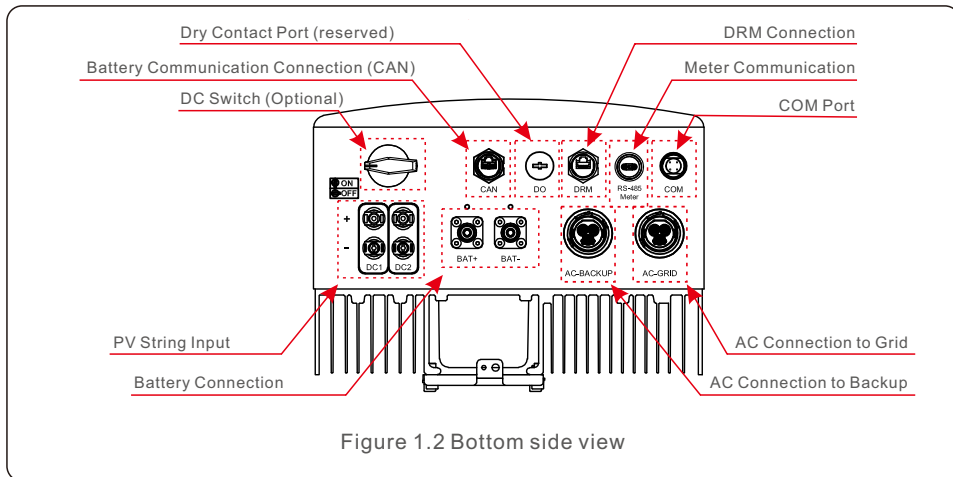
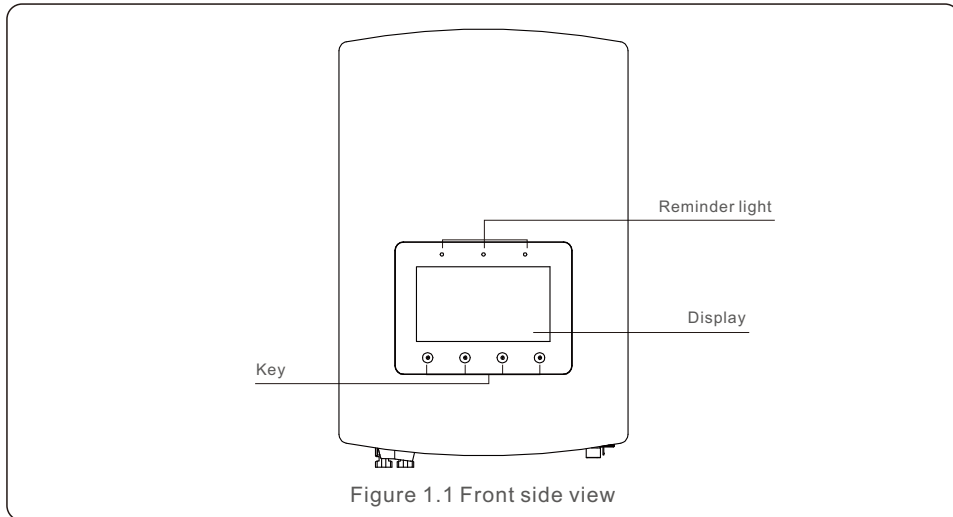

# 1. Introduction



## WARNING:

Please refer to the specification of the battery before configuration.

## 1.2 Packaging

Please ensure that the following items are included in the packaging with your machine:



If anything is missing, please contact your local Solis distributor.

# 2. Safety & Warning

## 2.1 Safety

The following types of safety instructions and general information appear in this document as described below:



**DANGER:**

“Danger” indicates a hazardous situation which if not avoided, will result in death or serious injury.



**WARNING:**

“Warning” indicates a hazardous situation which if not avoided, could result in death or serious injury.



**CAUTION:**

“Caution” indicates a hazardous situation which if not avoided, could result in minor or moderate injury.



**NOTE:**

“Note” provides tips that are valuable for the optimal operation of your product.



**WARNING: Risk of fire**

Despite careful construction, electrical devices can cause fires.

- Do not install the inverter in areas containing highly flammable materials or gases.
- Do not install the inverter in potentially explosive atmospheres.

## 2.2 General Safety Instructions



**WARNING:**

Only devices in compliance with SELV (EN 69050) may be connected to the RS485 and USB interfaces.



**WARNING:**

Please don't connect PV array positive (+) or negative (-) to ground, it could cause serious damage to the inverter.



**WARNING:**

Electrical installations must be done in accordance with the local and national electrical safety standards.



**WARNING:**

Do not touch any inner live parts until 5 minutes after disconnection from the utility grid and the PV input.

# 2. Safety & Warning



**WARNING:**

To reduce the risk of fire, over-current protective devices (OCPD) are required for circuits connected to the inverter.

The DC OCPD shall be installed per local requirements. All photovoltaic source and output circuit conductors shall have isolators that comply with the NEC Article 690, Part II.

All Solis single phase inverters feature an integrated DC switch.



**CAUTION:**

Risk of electric shock, do not remove cover. There is no user serviceable parts inside, refer servicing to qualified and accredited service technicians.



**CAUTION:**

The PV array supplies a DC voltage when they are exposed to sunlight.



**CAUTION:**

Risk of electric shock from energy stored in capacitors of the Inverter, do not remove cover for 5 minutes after disconnecting all power sources (service technician only). Warranty may be voided if the cover is removed without authorization .



**CAUTION:**

The surface temperature of the inverter can reach up to 75°C (167 F). To avoid risk of burns, do not touch the surface of the inverter while it's operating. Inverter must be installed out of the reach of children.



**NOTE:**

PV module used with inverter must have an IEC 61730 Class A rating.



**WARNING:**

Operations below must be accomplished by licensed technician or Solis authorized person.



**WARNING:**

Operator must put on the technicians' gloves during the whole process in case of any electrical hazards.



**WARNING:**

AC BACKUP Port of S5-EH1P-L Series is not allowed to connect to the grid.

## 2. Safety & Warning



**WARNING:**  
The S5-EH1P-L Series does not support parallel (three- and single-phase) operation on the AC-BACKUP port.  
Connecting multiple units in parallel will void the warranty.

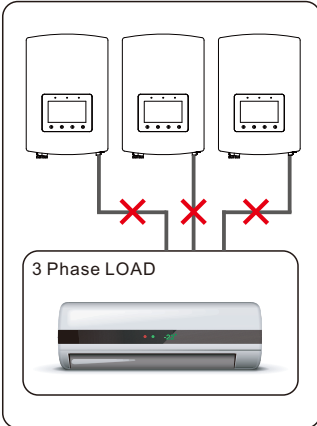

3 Phase LOAD

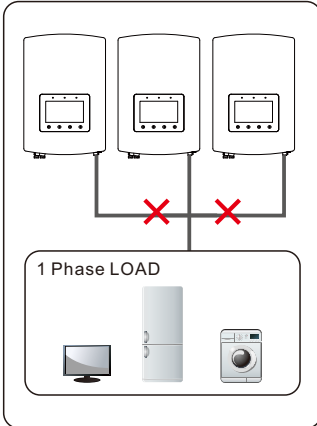

1 Phase LOAD

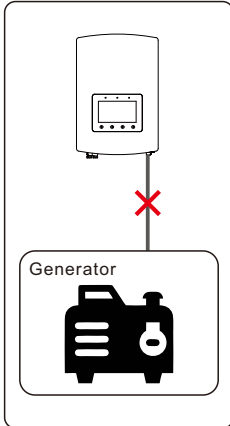

Generator



**WARNING:**  
Please refer to the specification of the battery before configuration.

### 2.3 Notice For Use

The inverter has been constructed according to the applicable safety and technical guidelines. Use the inverter in installations that meet the following specifications **ONLY**:

1. Permanent installation is required.
2. The electrical installation must meet all the applicable regulations and standards.
3. The inverter must be installed according to the instructions stated in this manual.
4. The inverter must be installed according to the correct technical specifications.

## 3. Overview

### 3.1 Screen

Solis S5-EH1P-L Series adopts 7 inch color screen, it displays the status, operating information and settings of the inverter.

### 3.2 Keypad

There are four keys in the front panel of the inverter (from left to right): ESC, UP, DOWN and ENTER keys. The keypad is used for:

- Scrolling through the displayed options (the UP and DOWN keys);
- Access and modify the settings (the ESC and ENTER keys).

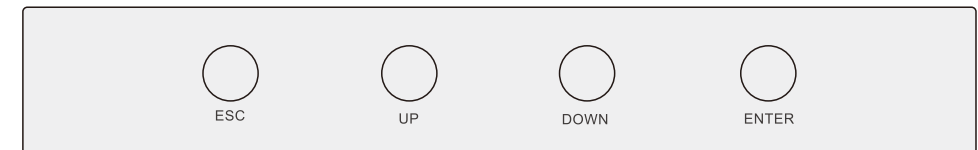

Figure 3.2 Keypad

### 3.3 LED Indicators

There are three LED indicators on the RHI inverter (Red, Green, and Orange) which indicate the working status of the inverter.



Light	Status	Description
● POWER	ON	The inverter can detect DC power.
	OFF	No DC power.
● OPERATION	ON	The inverter is fully operational.
	OFF	The inverter has stopped operating.
	FLASHING	The inverter is initializing.
● ALARM	ON	Fault condition is detected.
	OFF	No fault condition detected.
	FLASHING	Either the grid or solar cannot be detected.

Table 3.1 Status Indicator Lights

# 4. Installation

## 4.1 Select a Location for the Inverter

To select a location for the inverter, the following criteria should be considered:

- Exposure to direct sunlight may cause output power derating. It is recommended to avoid installing the inverter in direct sunlight.
- It is recommended that the inverter is installed in a cooler ambient which doesn't exceed 104°F/40°C.

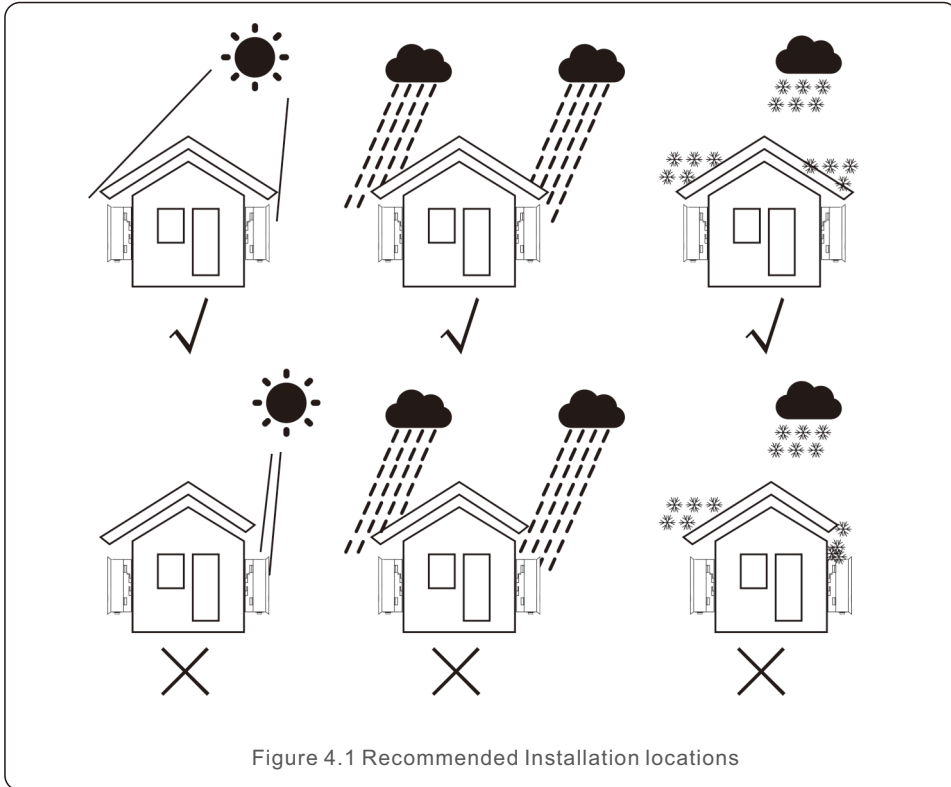

### WARNING: Risk of fire

Despite careful construction, electrical devices can cause fires.

- Do not install the inverter in areas containing highly flammable materials or gases.
- Do not install the inverter in potentially explosive atmospheres.
- The mounting structure where the inverter is installed must be fireproof.

# 4. Installation

- Install on a wall or strong structure capable of bearing the weight of the machine (18.3kg).
- Install vertically with a maximum incline of +/- 5 degrees, exceeding this may cause output power derating.
- To avoid overheating, always make sure the flow of air around the inverter is not blocked. A minimum clearance of 300mm should be kept between inverters or objects and 500mm clearance between the bottom of the machine and the ground.

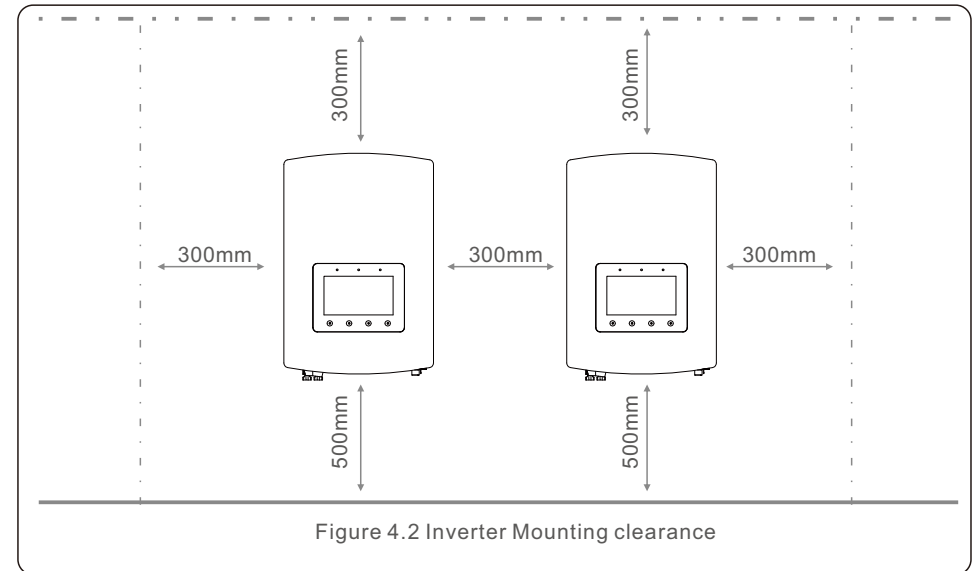

- Visibility of the LEDs and LCD should be considered.
- Adequate ventilation must be provided.



### NOTE:

Nothing should be stored on or placed against the inverter.

# 4. Installation

# 4. Installation

## 4.2 Mounting the Inverter

Dimensions of mounting bracket:

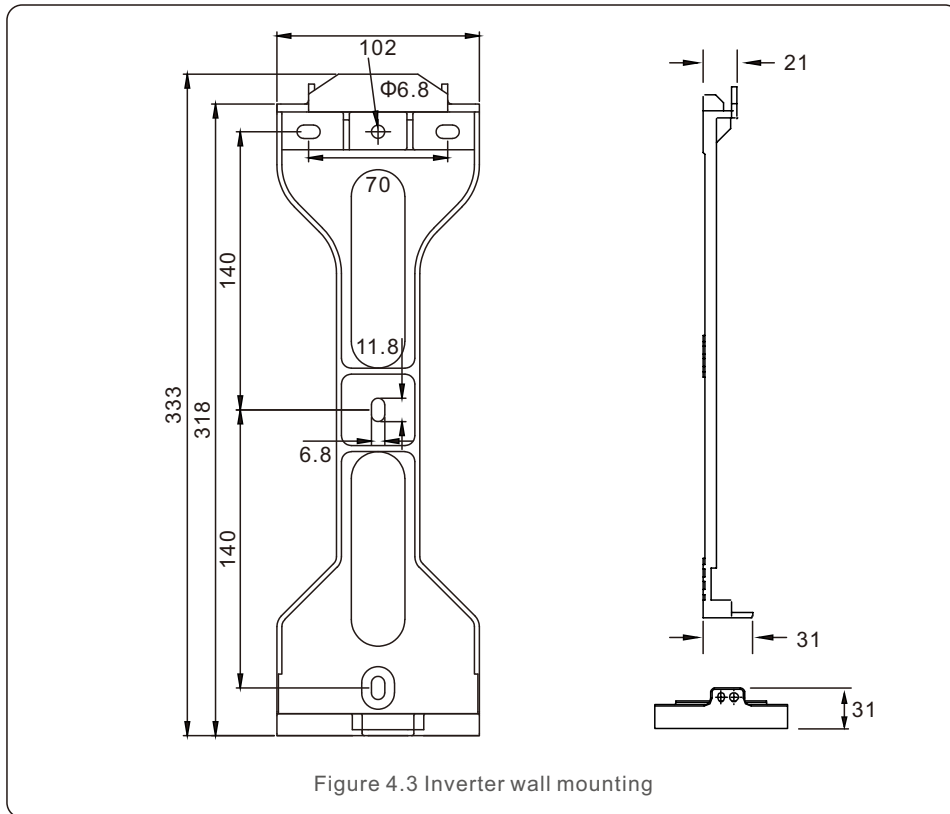

Once a suitable location has been found accordingly to 4.1 using figure 4.3 and figure 4.4 mount the wall bracket to the wall.

The steps to mount the inverter are listed below:

1. Select the mounting height of the bracket and mark the mounting holes.  
For brick walls, the position of the holes should be suitable for the expansion bolts.

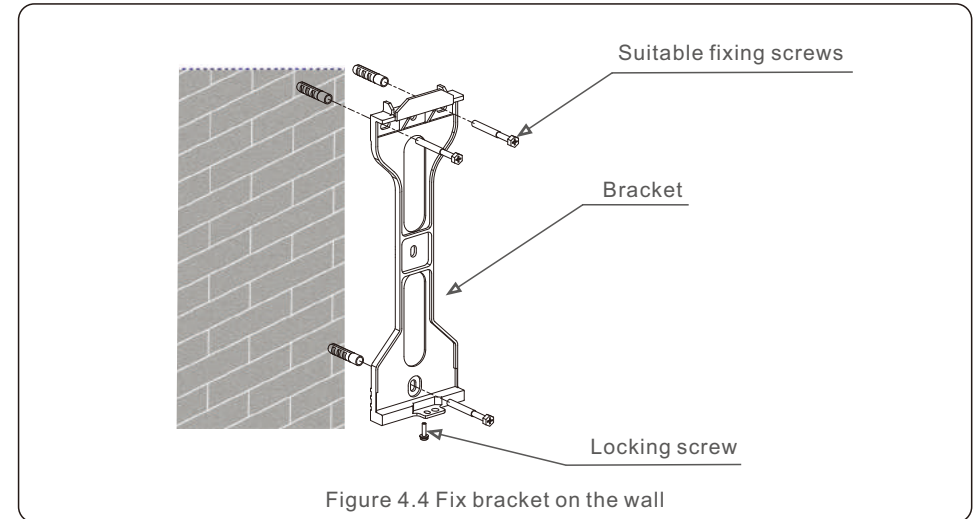

### WARNING:

The inverter must be mounted vertically.

2. Lift up the inverter (be careful to avoid injury), and align the back bracket on the inverter with the convex section of the mounting bracket. Hang the inverter on the mounting bracket and make sure the inverter is secure (see Figure 4.5)

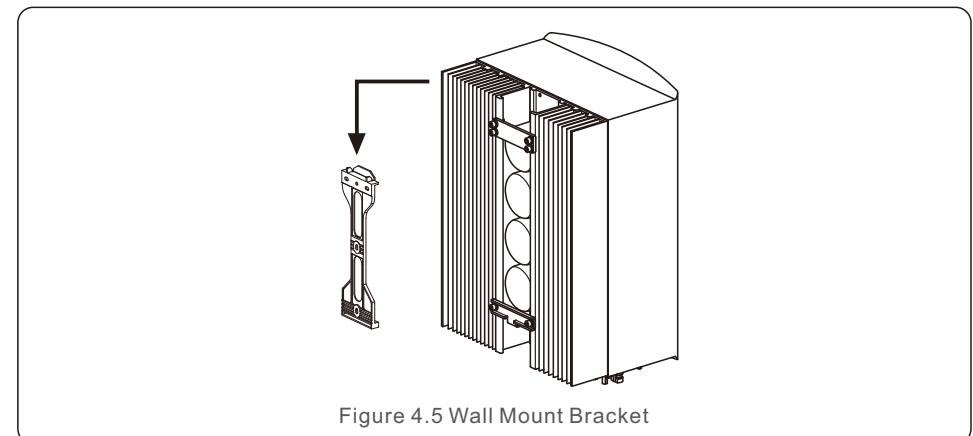

# 4. Installation

## 4.3 PE Cable Installation

An external ground connection is provided at the right side of inverter.  
 Prepare OT terminals: M4. Use proper tooling to crimp the lug to the terminal.  
 Connect the OT terminal with ground cable to the right side of inverter. The torque is 2Nm.

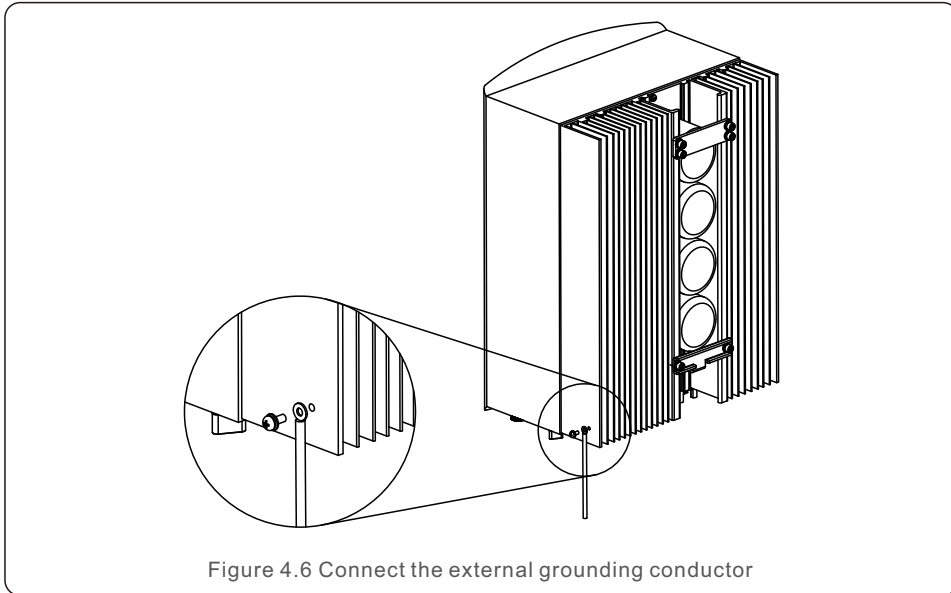

# 4. Installation

## 4.4 PV Input Cable Installation



Before connecting inverter, please make sure the PV array open circuit voltage is within the limit of the inverter.



Before connection, please make sure the polarity of the output voltage of PV array matches the "DC+" and "DC-" symbols.



Please use approved DC cable for PV system.

1. Select a suitable DC cable and strip the wires out by  $7 \pm 0.5$ mm. Please refer to the table below for specific specifications.

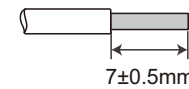

Cable type	Cross section (mm <sup>2</sup> )	
	Range	Recommended value
Industry generic PV cable ( model:PV1-F )	4.0~6.0 (12~10AWG)	4.0 (12AWG)

Figure 4.7

2. Take the DC terminal out of the accessory bag, turn the screw cap to disassemble it, and take out the waterproof rubber ring.

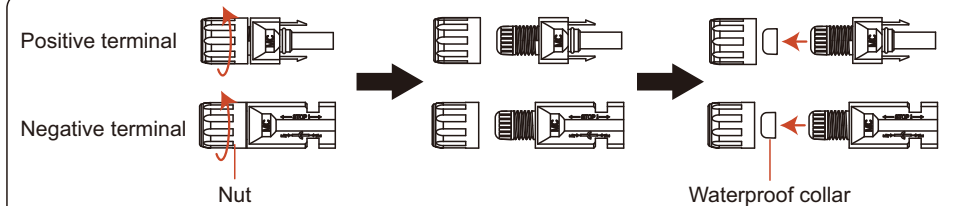
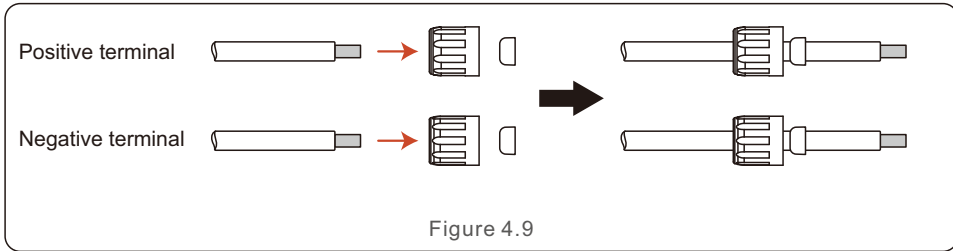

Figure 4.8



# 4. Installation

3. Pass the stripped DC cable through the nut and waterproof rubber ring.



4. Connect the wire part of the DC cable to the metal DC terminal and crimp it with a special DC terminal crimping tool.

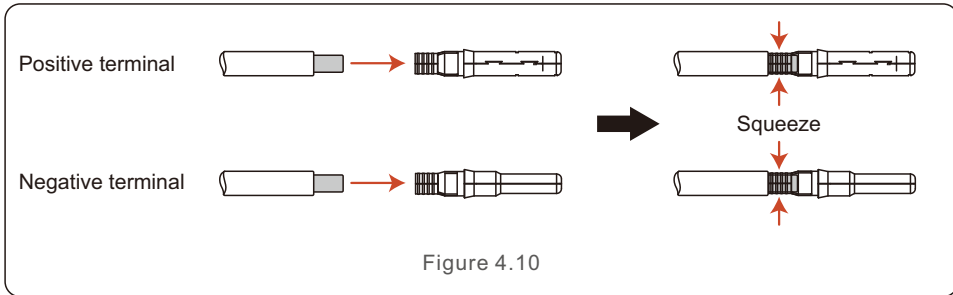

5. Insert the crimped DC cable into the DC terminal firmly, then insert the waterproof rubber ring into the DC terminal and tighten the nut.

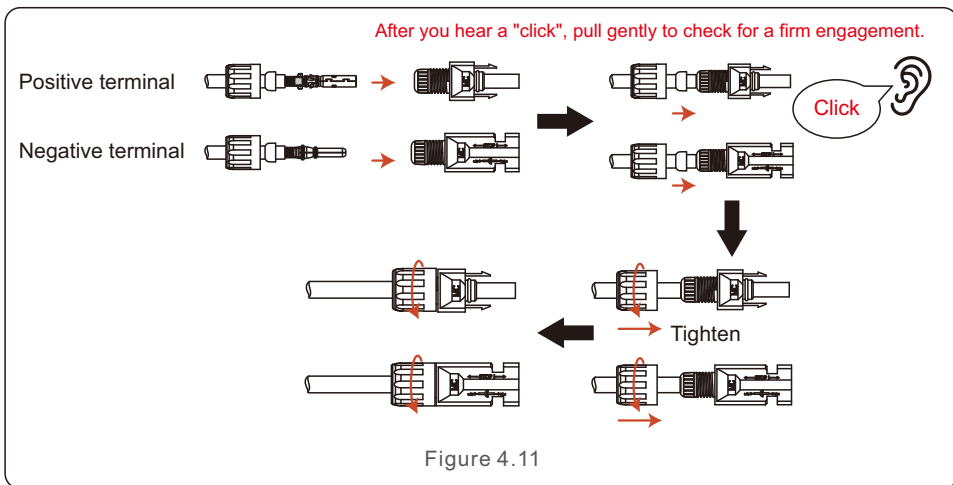

# 4. Installation

6. Measure PV voltage of DC input with multimeter, verify DC input cable polarity.

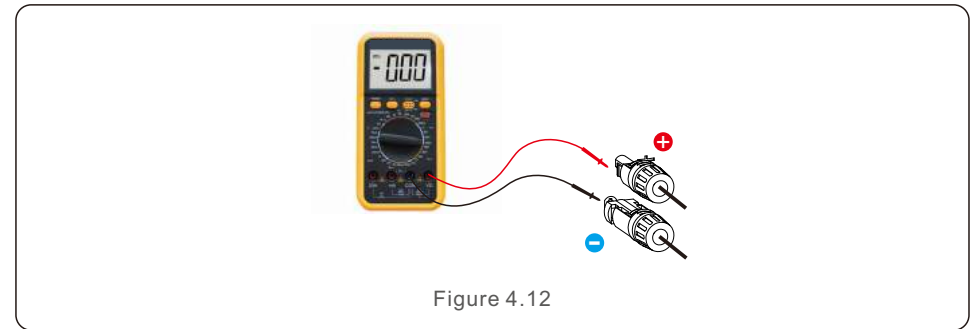

7. Connect the wired DC terminal to the inverter as shown in the figure, and a slight "click" is heard to prove the connection is correct.

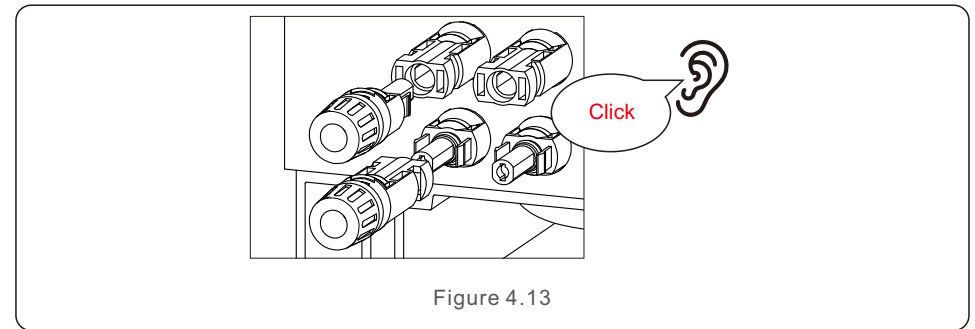

### CAUTION:

If DC inputs are accidentally reversely connected or inverter is faulty or not working properly, it is NOT allowed to turn off the DC switch. Otherwise it may cause DC arc and damage the inverter or even lead to a fire disaster. The correct actions are:

- \*Use a clip-on ammeter to measure the DC string current.
  - \*If it is above 0.5A, please wait for the solar irradiance reduces until the current decreases to below 0.5A.
  - \*Only after the current is below 0.5A, you are allowed to turn off the DC switches and disconnect the PV strings.
  - \* In order to completely eliminate the possibility of failure, please disconnect the PV strings after turning off the DC switch to avoid secondary failures due to continuous PV energy on the next day.
- Please note that any damages due to wrong operations are not covered in the device warranty.

# 4. Installation

## 4.5 Battery Power Cable Installation

### 4.5.1 Normal battery cable installation



**NOTE:**

External battery switch must be installed between the battery and inverter for safe maintenance purpose if the battery does not have built-in DC breaker.

The battery switch must have a rated current greater than or equal to 80A/125A (80A for 3K~3.6K Models, 125A for 4.6K~6K Models).

Connect the Battery cable to the inverter and make sure the positive and negative poles are correct. A "Click" sound means fully connection and fasten the cables with the terminal protection cover as indicated in Figure 4.14.

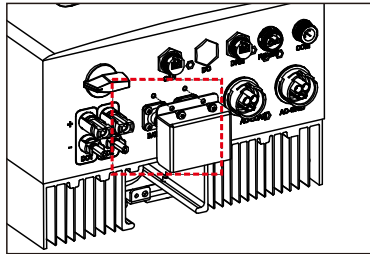

Figure 4.14 Installation of Terminal Protection Cover

To remove the battery connection, please ensure the system is powered off and then remove the terminal protection cover. When disconnect the battery cables, please press the button as indicated in the figure while pulling out the cable.

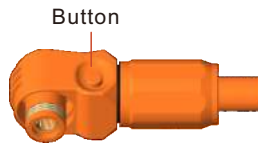

Figure 4.15



**NOTE:**

Before connecting the battery, please carefully read the user manual of the battery and perform the installation exactly as the battery manufacturer requests.

# 4. Installation

### 4.5.2 Extended battery cable installation

If the battery cable size is required to be changed by the battery manufacturer, please refer to following content for the cable preparation. Otherwise, you may skip these steps.

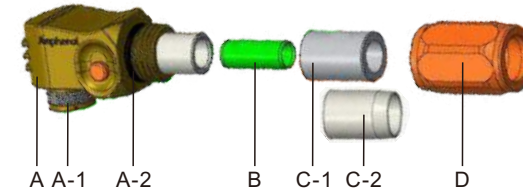

Figure 4.16

A: Connector Body

A-1: Barrel sealing (Not included when no sealing requirement)

A-2: O-Ring (Not included when no sealing requirement)

B: Barrel(Only for cable size 16mm<sup>2</sup> )

C: Grommet(Not included when no sealing requirement)

C-1: For 16mm<sup>2</sup>

C-2: For 25mm<sup>2</sup>

D: Back Shell

Step 1: Wire cutting and stripping (Apply for 10mm<sup>2</sup> & 16mm<sup>2</sup> Cable)

Stripping conductor: 18±1mm

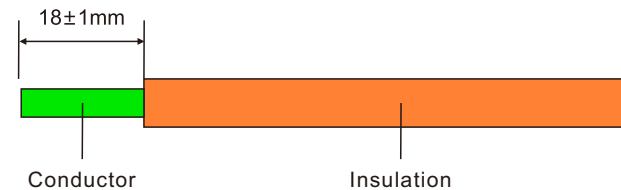
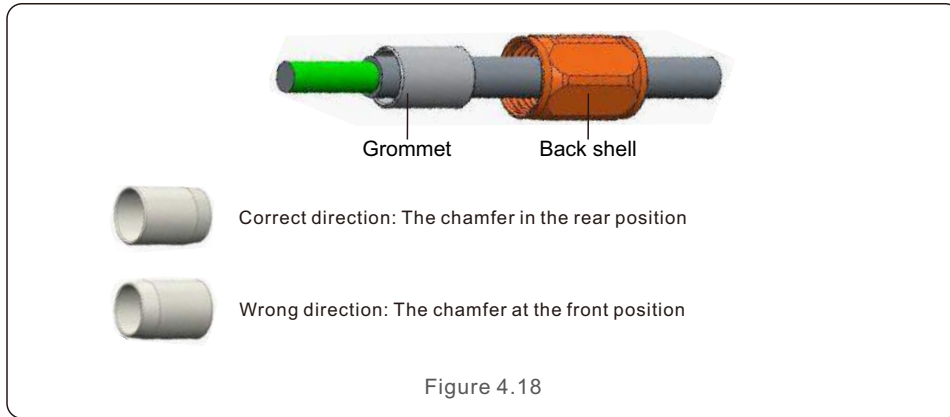

Figure 4.17

# 4. Installation

Step 2: Un-assemble Grommet and Back shell over the cable as shown.



Step 3: Put the barrel and the cable conductor into the lug.

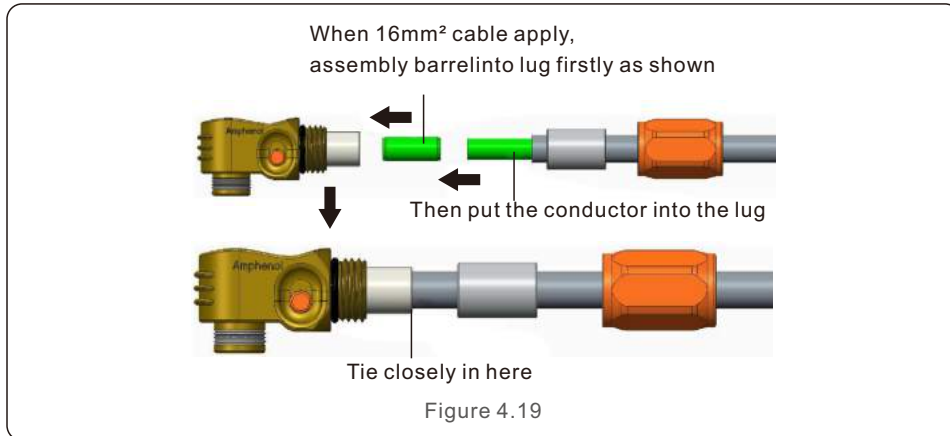

# 4. Installation

Step 4: Crimping the lug as shown.

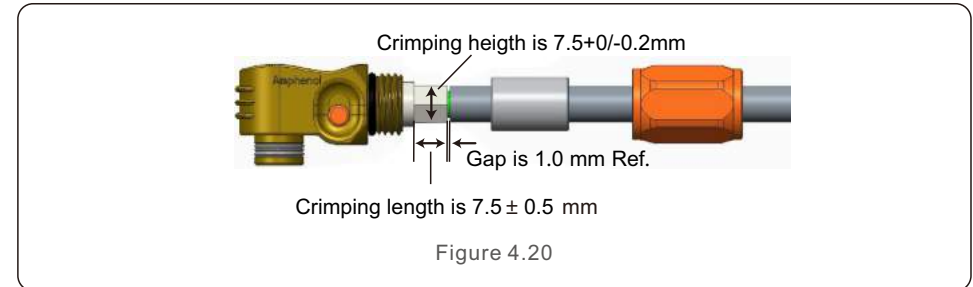

Cable size	Cable range	Crimping height	Cable pullout force
16mm <sup>2</sup>	8.10±0.20mm	7.5+0/-0.2mm	1000N Min.
25mm <sup>2</sup>	10.20±0.20mm		1200N Min.

Table 4.1

Recommended crimping tool: Manual hydraulic crimping  
Die: 25 mm<sup>2</sup>



# 4. Installation

Step 5: Install grommet and back shel.

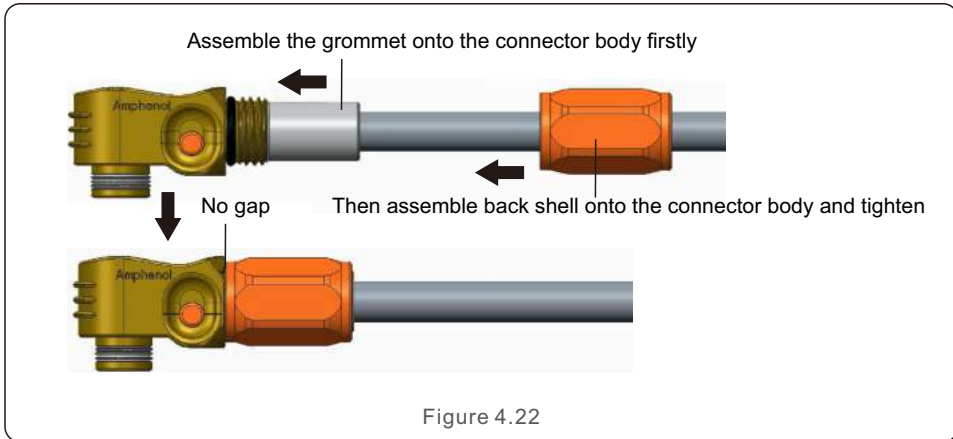

# 4. Installation

## 4.6 AC Cable Installation

There are two AC terminals and the assembly steps for both are the same. Take out the AC connector parts from the packaging.

Describe	Numerical value
Cable diameter	10~14mm
Traverse cross sectional area	6~8mm <sup>2</sup>
Exposure Length	9mm

Table 4.2

1. Disassemble the AC connector. Strip the AC wires about 9mm.

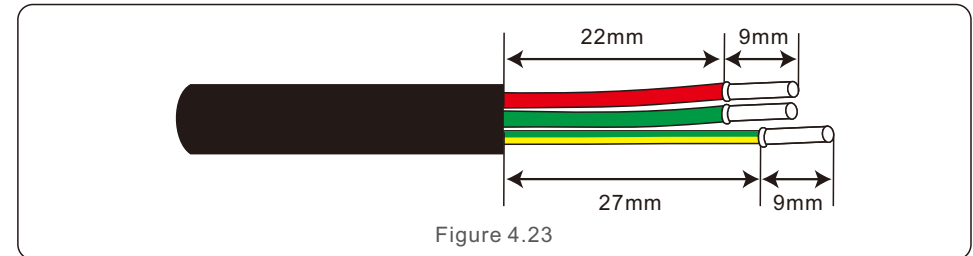

2. Set the parts on the cable.

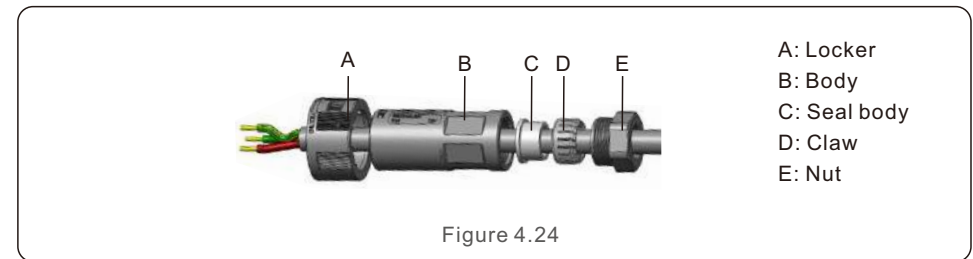

3. Crimp wires screw twisting torque 0.8+/-0.1N·m.

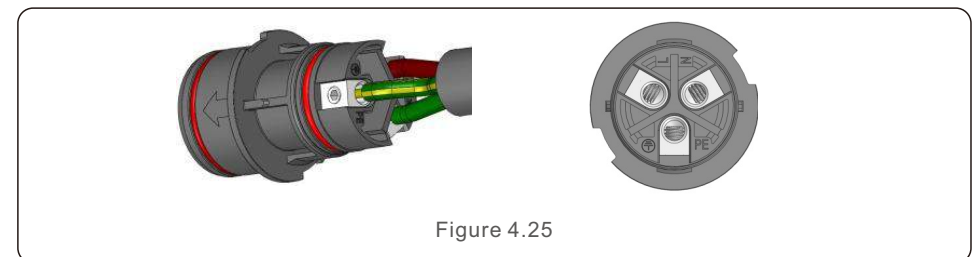

# 4. Installation

4. Push Housing into Body.

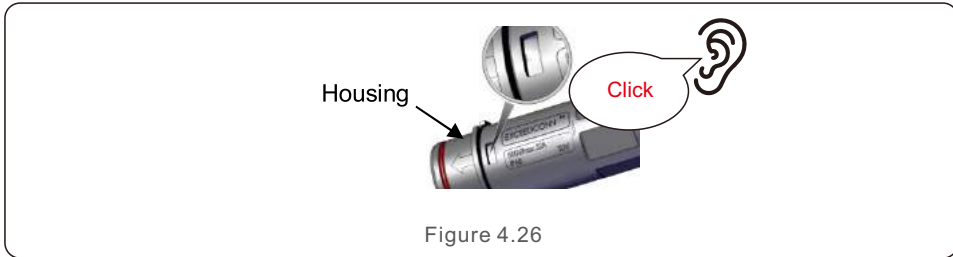

Figure 4.26

5. Insert Seal and Clamp Finger into socket ,then tighten the nut , torque 4+/-0.5N·m.

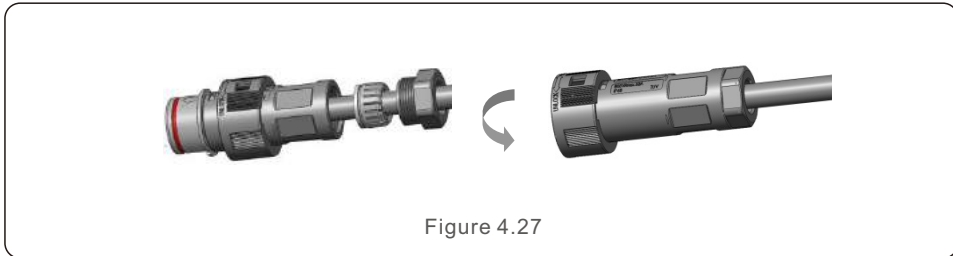

Figure 4.27

6. The same installation for both cable end plug and socket connectors.

7. Mating plug and socket: Push the plug into the socket completely, then rotate the locker according to the direction instructed by the marks on the locker.

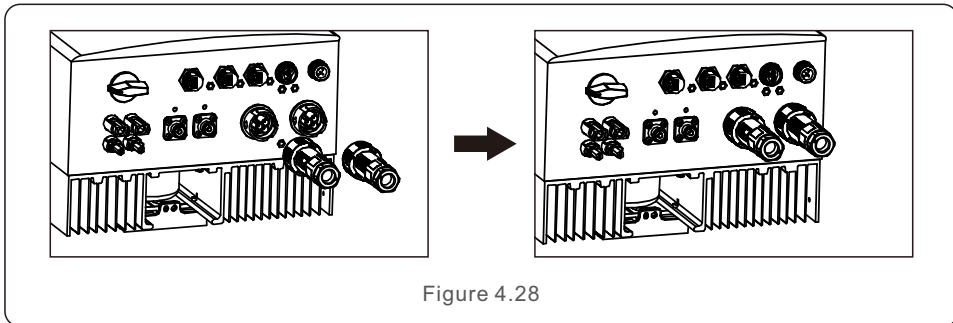

Figure 4.28



**NOTE:**

Before mating the plug and socket, please double check both AC Grid and AC Backup connectors. Do not connect the grid cables to the AC Backup port or connect the backup load cables to the AC Grid Port. Otherwise, it may leads to malfunction or damage.

# 4. Installation

## 4.7 Communication Cable Installation

### 4.7.1 Communication Port Definition

Picture	Port	Function
	CAN Port	1. Used for CAN communication between inverter and lithium battery BMS. 2. (Optional) Used for battery temperature sensor connection when lead-acid battery is used.
	RS-485 Meter Port	1. Used for RS485 communication between inverter and the compatible smart meter. It is necessary to realize the normal hybrid control logics.
	DRM Port	1. (Optional) To realize Demand Response or Logic interface function, this function may be required in UK and Australia.
	COM Port	1. (Optional) Used for Solis Data Logger Connection. 2. (Optional) Used for Modbus RTU communication with a 3rd party external device.

Table 4.3

### 4.7.2 CAN Port Connection

#### 4.7.2.1 CAN Communication with Lithium Battery

1. A 3m length pre-made CAN cable is provided in the accessory package with one end marked with "To CAN" and the other end marked with "To Battery".

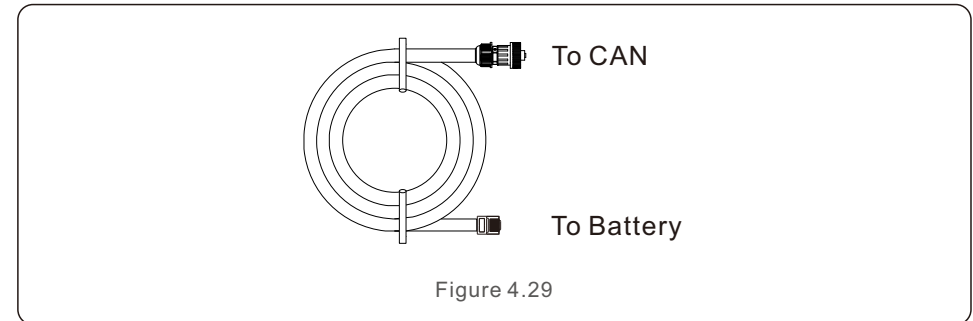

Figure 4.29

2. Insert the RJ45 terminal on the end of the CAN cable (Marked with "To CAN") to the CAN port at the bottom of the inverter and fasten the swivel nut.

3. Connect the other end marked with "To Battery" to the battery.

# 4. Installation

# 4. Installation

**NOTE:**

Before connecting CAN cable with the battery, please check whether the communication pin sequence of the inverter and the battery match; If it does not match, you need to cut off the RJ45 connector at one end of the CAN cable and adjust the pin sequence according to the pin definitions of both inverter and battery.

Pin definition of the inverter CAN Port is following EIA/TIA 568B.

CAN-H on Pin 4: Blue  
CAN-L on Pin 5: Blue/White

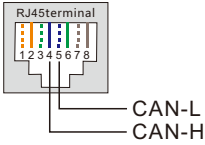

## 4.7.2.2 Battery Temperature Sensor Connection for Lead-acid Battery (Optional)

**NOTE:**

Battery temperature sensor can be optionally used with lead-acid battery for inverters to accurately detect the battery ambient temperature and adjust voltage compensation based on the customer-defined coefficient. It is an optional accessory which may not be provided with the inverter package. If lead-acid battery is used and battery temperature sensor is needed, please contact your distributor or Solis sales to purchase individually.

1. Insert the RJ45 terminal end to the CAN port at the bottom of the inverter and fasten the swivel nut. (Cable length: 1 meter)
2. Fasten the temperature sensor ring onto the battery module. If no suitable fastening terminal can be found on the battery module, the sensor ring can be attached to the positive or negative pole of the battery module.

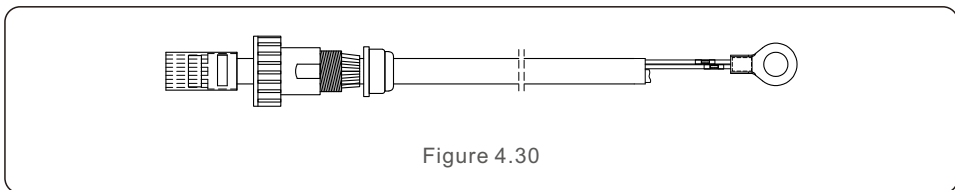

## 4.7.3 RS485 Meter Port Connection

### 4.7.3.1 RS485 Meter Connector Assemble Steps

A 2-pin connector with 5m RS485 cable for meter communication can be found in the package. If extending the RS485 cable, please ensure the distance is within 100m and twisted shielded RS485 cable should be used to prevent signal interference.

Red wire is RS485A  
Black wire is RS485B

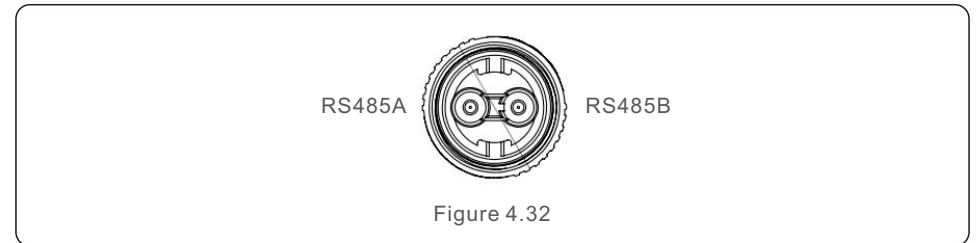
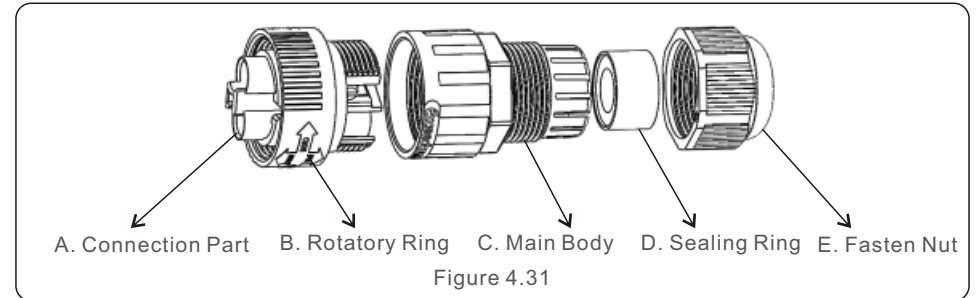

### 4.7.3.2 Compatible Smart Meter RS485 Connection

Compatible Smart Meter Model	Meter RS485 Pin Definition
SDM120CT (Default)	Pin 9 – RS485B, Pin 10 – RS485A
SDM120M	Pin 9 – RS485B, Pin 10 – RS485A
SDM630MCT	Pin 13 – RS485B, Pin 14 – RS485A
SDM630	B – RS485B, A – RS485A
ACR10R16DTE	RJ45 Port on the meter Pin 7 – RS485B, Pin 8 – RS485A
ACR10R16DTE4	Pin 21 – RS485A, Pin 22 – RS485B

Table 4.4

# 4. Installation

# 4. Installation

## 4.7.4 DRM Port Connection (Optional)

### 4.7.4.1 For Remote Shutdown Function

Solis inverters support remote shutdown function to remotely control the inverter to power on and off through logic signals.

The DRM port is provided with an RJ45 terminal and its Pin5 and Pin6 can be used for remote shutdown function.

Signal	Function
Short Pin5 and Pin6	Inverter Generates
Open Pin5 and Pin6	Inverter Shutdown in 5s

Table 4.5

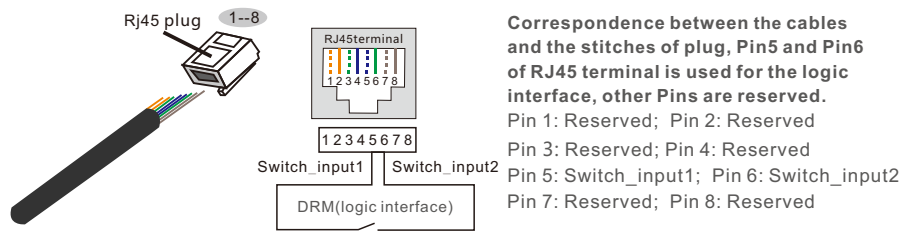

Figure 4.33 Strip the insulation layer and connect to RJ45 plug

### 4.7.4.2 For DRED Control Function (For AU and NZ Only)

DRED means demand response enable device. The AS/NZS 4777.2:2020 required inverter need to support demand response mode(DRM).

This function is for inverter that comply with AS/NZS 4777.2:2020 standard.

A RJ45 terminal is used for DRM connection.

Pin	Assignment for inverters capable of both charging and discharging	Pin	Assignment for inverters capable of both charging and discharging
1	DRM 1/5	5	RefGen
2	DRM 2/6	6	Com/DRM0
3	DRM 3/7	7	V+
4	DRM 4/8	8	V-

Table 4.6



**NOTE:**

Solis hybrid inverter is designed to provide 12V power for DRED.

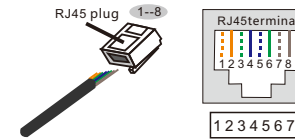

**Correspondence between the cables and the stitches of plug**  
 Pin 1: white and orange ; Pin 2: orange  
 Pin 3: white and green ; Pin 4: blue  
 Pin 5: white and blue ; Pin 6: green  
 Pin 7: white and brown ; Pin 8: brown

Figure 4.34 Strip the insulation layer and connect to RJ45 plug

## 4.7.5 COM Port Connection (Optional)

COM Port can be used for either Solis Data Logger connection or 3rd party monitoring/control device with Modbus RTU communication.

### 4.7.5.1 Solis Data Logger Installation

1. Remove the watertight cap from the COM port.
2. Insert the Solis Data Logger to the COM port to match the joint.



Match the joint

Figure 4.35

3. Rotate the black ring on the Solis Data Logger in clockwise to secure the connection.



**NOTE:**

Do not rotate the main body of the Solis Data Logger. It may damage the logger and the inverter COM port.

# 4. Installation



Figure 4.36

## 4.7.5.2 Third party monitoring/control device connection

If a third party monitoring/control device need to be connected directly to the inverter, the COM port can be used with a special connector to extend the RS485A and RS485B pins, please contact Solis local service team or Solis sales for this special connector.



Figure 4.37

Modbus RTU protocol is supported by Solis inverters. To acquire latest protocol document, please contact Solis local service team or Solis sales.

## 4.8 Meter Installation



**CAUTION:**

Make sure the AC cable is totally isolated from AC power before connecting the Smart Meter and CT.

A Smart Meter with the CT in product box is compulsory for hybrid system installation. It can be used to detect the grid voltages and current directions, provide the operating condition of the hybrid inverter via RS485 communications.

# 4. Installation



**NOTE:**

1. The Smart Meter with CT is already configured ; please do not change any settings on the Smart Meter.
2. One Smart Meter can be used with only one hybrid inverter.

The Solis S5-EH1P-L Series inverter is able to connected Acrel meters or Eastron meters to fulfill the control logic of the self-consumption mode, export power control, monitoring, etc.

Acrel 1ph meter (With CT): ACR10R-D16TE (Optional)

Acrel 3ph meter (With CT): ACR10R-D16TE4 (Optional)

Easton 1ph meter (Direct Insert): SDM120M (Optional)

Easton 1ph meter (With CT): SDM120CT

Easton 3ph meter (Direct Insert): SDM630 (Optional)

Easton 3ph meter (With CT): SDM630MCT (Optional)

Below 4.8.1 section describes the connection diagram of 1ph meter Easton SDM120CT and Acrel ACR10R-D16TE.

Below 4.8.2 section describes the connection diagram of 3ph meter Easton SDM630MCT and Acrel ACR10R-D16TE4.



**NOTE:**

Please note that the CT orientation must be correct, otherwise the system will not work properly.



Compatible Smart Meter Model	Meter RS485 Pin Definition
SDM120CT (Default)	Pin 9 – RS485B, Pin 10 – RS485A
SDM120M	Pin 9 – RS485B, Pin 10 – RS485A
SDM630MCT	Pin 13 – RS485B, Pin 14 – RS485A
SDM630	B – RS485B, A – RS485A
ACR10R16DTE	RJ45 Port on the meter Pin 7 – RS485B, Pin 8 – RS485A
ACR10R16DTE4	Pin 21 – RS485A, Pin 22 – RS485B

Table 4.7



# 4. Installation

## 4.8.1 Single phase meter installation

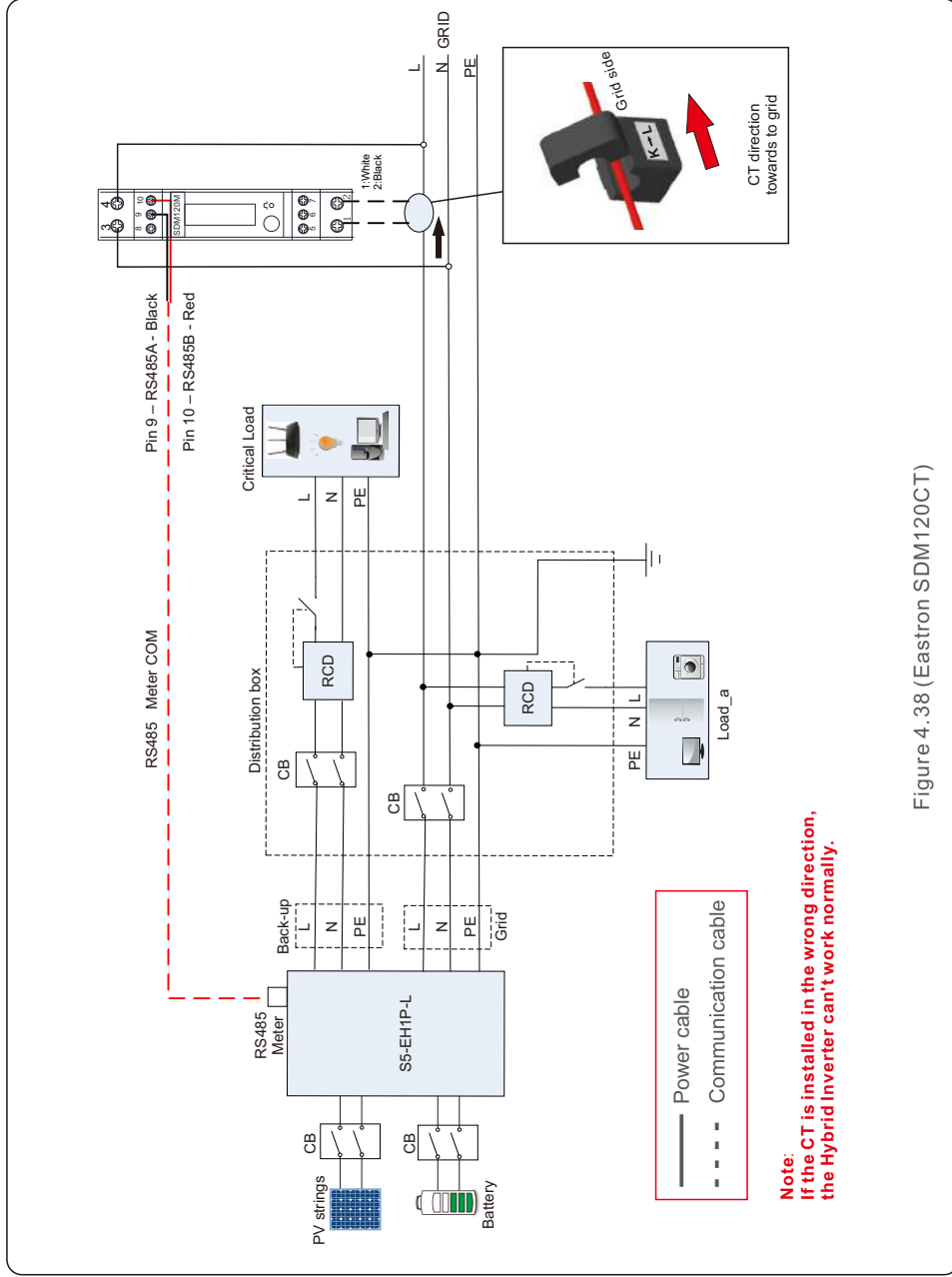

# 4. Installation

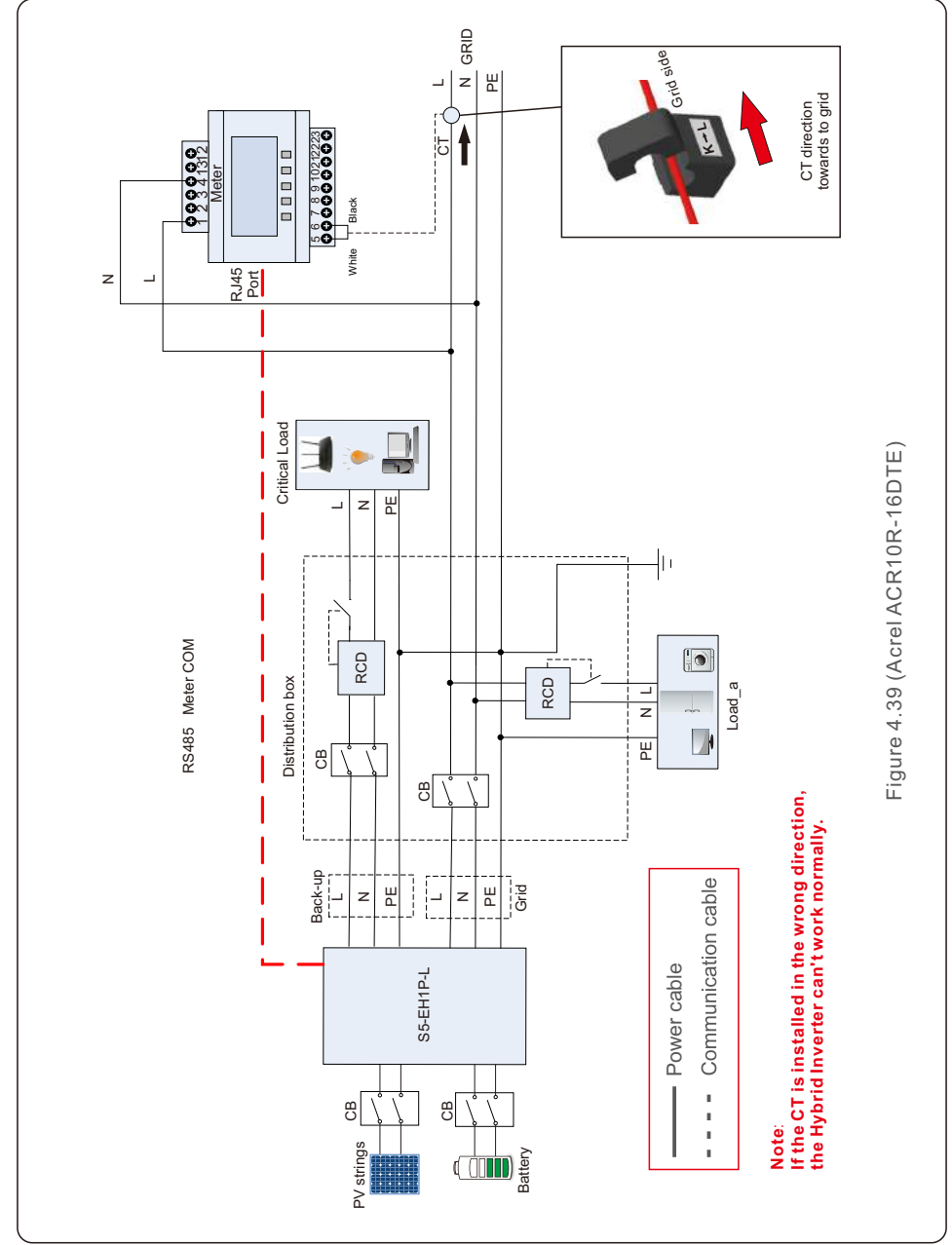

# 4. Installation

## 4.8.2 Three phase meter installation

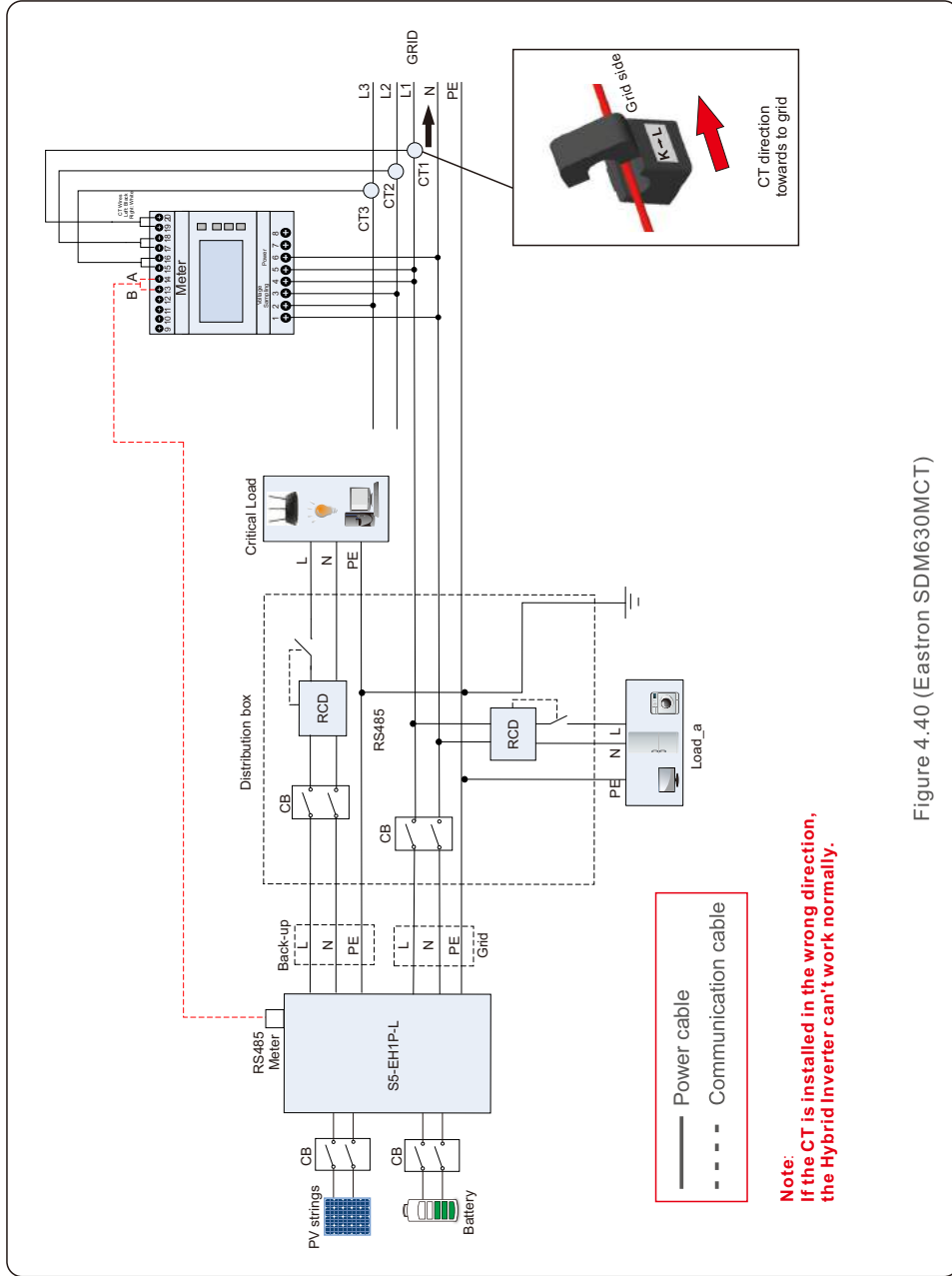

Figure 4.40 (Eastron SDM630MCT)

# 4. Installation

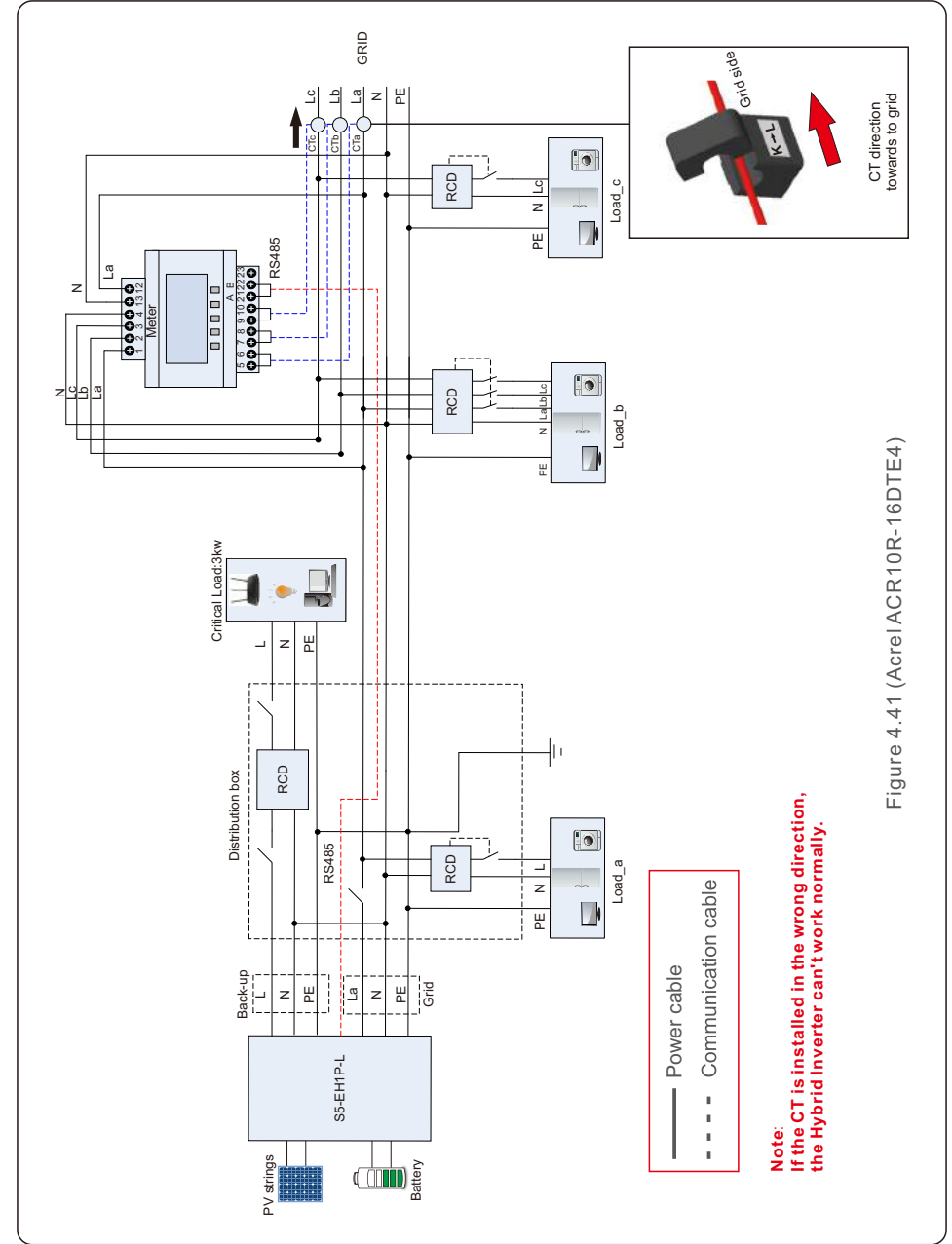

Figure 4.41 (Acrel ACR10R-16DTE4)

# 4. Installation

## 4.9 Max. over current protect protection device(OCPD)

To protect the inverter's AC grid connection conduction conductors, Solis recommends installing breakers that will protect against overcurrent. The following table defines OCPD ratings for the Solis S5 Single Phase 3-6kW PV Hybrid Inverter.

Inverter	Rated output voltage(V)	Rated output current (A)	Current for protection device (A)
S5-EH1P3K-L	220/230	13.7/13.0	20
S5-EH1P3.6K-L	220/230	16.4/15.7	25
S5-EH1P4.6K-L	220/230	20.9/20.0	32
S5-EH1P5K-L	220/230	22.8/21.7	32
S5-EH1P6K-L	220/230	27.3/26.1	40
S5-EH1P3K-L-BE	220/230	13.7/13.0	20
S5-EH1P3.6K-L-BE	220/230	16.4/15.7	25
S5-EH1P4.6K-L-BE	220/230	20.9/20.0	32
S5-EH1P5K-L-BE	220/230	22.8/21.7	32

Table 4.3 Rating of grid OCPD

# 5. Commissioning

## 5.1 Preparation of Commissioning

- Ensure all the devices are accessible for operation, maintenance and service.
- Check and confirm that the inverter is firmly installed.
- Space for ventilation is sufficient for one inverter or multiple inverters.
- Nothing is left on the top of the inverter or battery module.
- Inverter and accessories are correctly connected.
- Cables are routed in safe place or protected against mechanical damage.
- Warning signs and labels are suitably affixed and durable.

## 5.2 Commissioning Procedure

### 5.2.1 Recommended Installation

1. Measure DC voltage of PV strings and battery and ensure the polarity is correct.

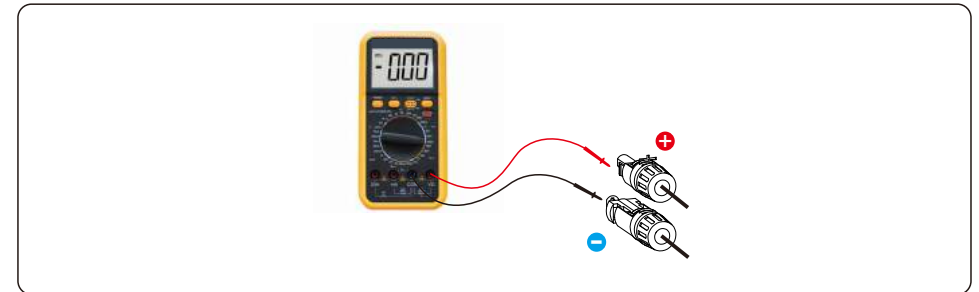

2. Measure AC voltage and frequency and ensure they are within local standard.

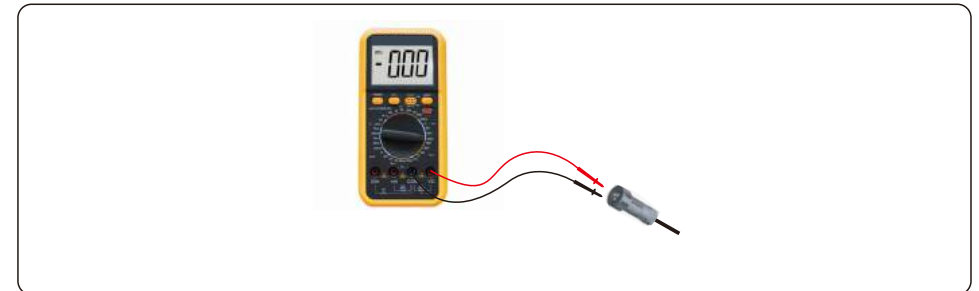

3. Switch on the external AC breaker to power on the LCD of the inverter.

# 5. Commissioning

# 5. Commissioning

4. Enter advanced settings (do not repeat this step for all subsequent operations).

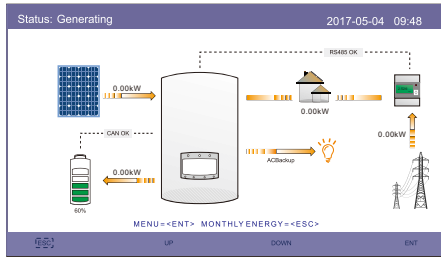

Step 1

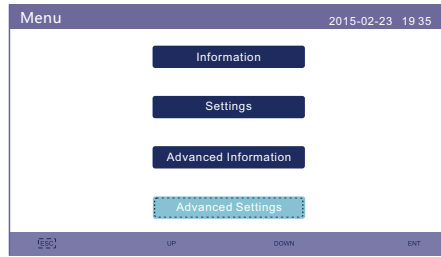

Step 2

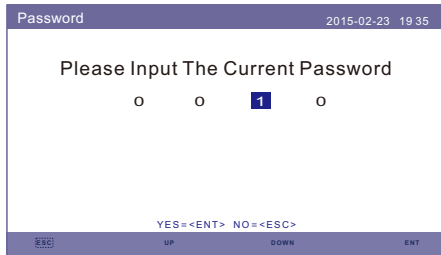

Step 3

5. Select the local grid standard code.

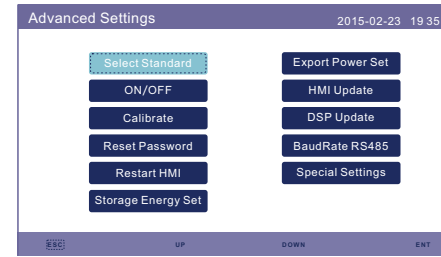

Step 1

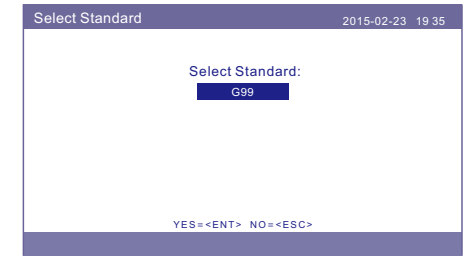

Step 2

NO.	Code in LCD	Applicable Country/Region
1	VDE4015	Germany
2	DK1	East Denmark
3	DK2	West Denmark
4	EN50438L	Applicable in some European countries
5	France	France
6	C10/11	Belgium
7	NRS097	South Africa
8	CEI-021	Italy
9	RD1699	Spain
10	EN50549	Applicable in some European countries
11	G98	UK
12	G99	UK
13	G98NI	North Ireland
14	G99NI	North Ireland
15	EN50549IE	Ireland

Applicable Country/Region

# 5. Commissioning

6. Check the backup supply settings. If you don't have a backup circuit on the backup port, disable it. Otherwise, keep it as enable and refer to section 4.6 for the installation process of AC backup connector.

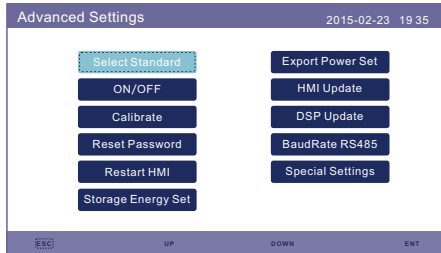

Step 1

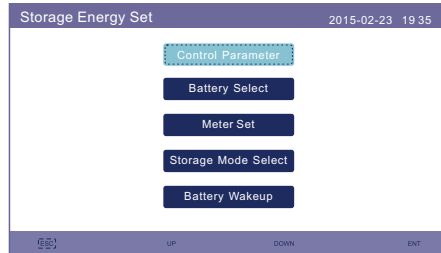

Step 2

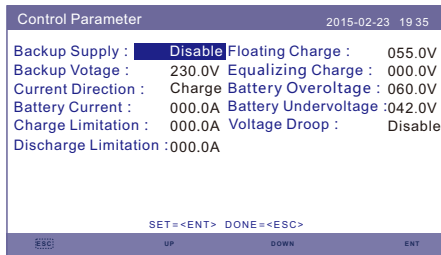

Step 3

# 5. Commissioning

7. Select the battery option and set battery SOC

The default setting for overdischarge SOC is 20%, force charging SOC is 10%, force charge current limit is 100A. If other setting is needed please follow 6.6.6.2 for detail. PS. If you don't have battery connected, set it to "No Battery".

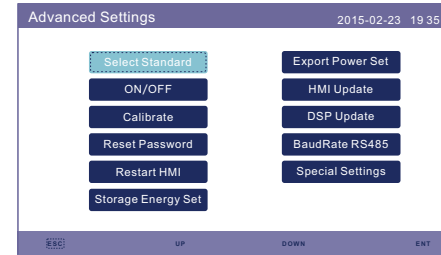

Step 1

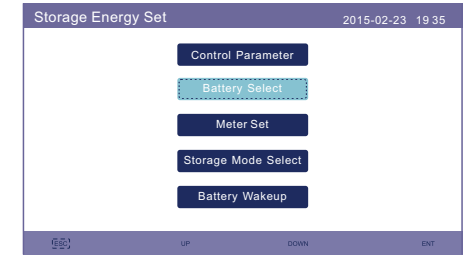

Step 2

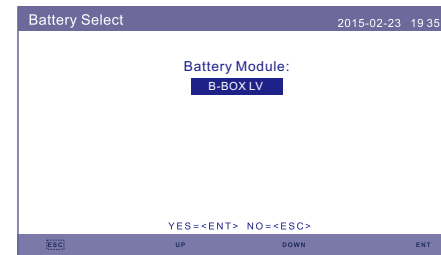

Step 3

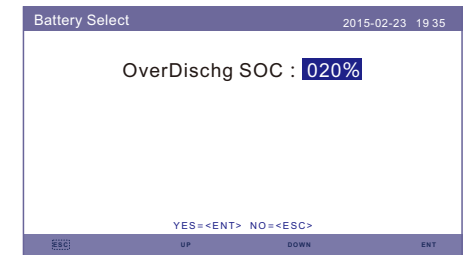

Step 4

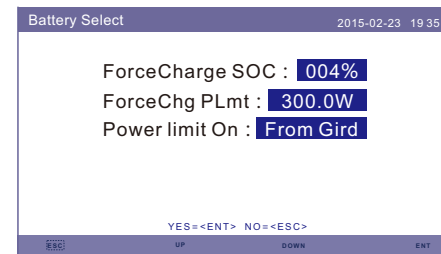

Step 5

# 5. Commissioning

# 5. Commissioning

Brand	Model	Setting
BYD	Box Pro 2.5-13.8	Select "B-BOX"
LG Energy Solution	RESU 3.3/6.5/10/13 (CEI 0-21)	Select "LG Chem"
Pylontech	US2000(CEI 0-21)/US3000(CEI 0-21)/ ForceL1(CEI 0-21)/ForceL2(CEI 0-21)/ Phantom-S/US2000C/US3000C/UP5000	Select "Pylon"
Dyness	Powerdepot/Powerbox/B4850	Select "Dyness"
Puredrive	48V-100Ah	Select "Puredrive"
AOBOET	AOBOET Uhome-LFP 6.8kWh	Select "AoBo"
WECO	5K3-R20	Select "WECO"
Green	Home E11	Select "Green"
Soluna	4K PACK	Select "Soluna"
Highstar	HSD5870	Select "Highstar"
Freedom	Freedom Won Lite	Select "Freedom"
KODAK	FL5.2	Select "KODAK"
FOX	LV5200	Select "FOX"
UZ Energy	L051100-A	Select "CATL"
GSL	48V-100Ah	Select "GSL"
ZETARA POWER	51.2V-100Ah	Select "ZETARA"

Battery Select

8. Select the storage work mode.

Recommended settings - Self-Use Mode. This mode can maximize the use of photovoltaic power generation directly for household electricity, or store it in batteries and use it for household electricity. If the other mode need to be used, please follow 6.6.6.4.

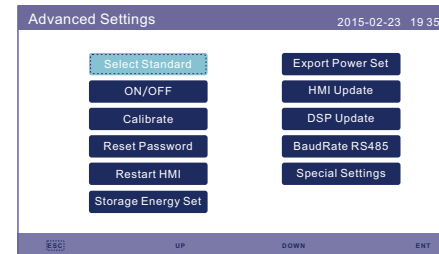

Step 1

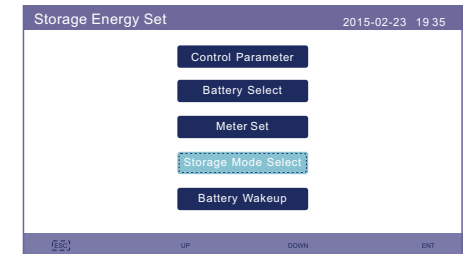

Step 2



Step 3

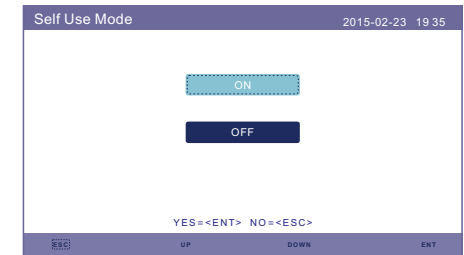

Step 4

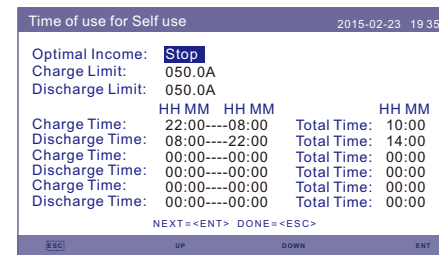

Step 5



Step 6



**NOTE:**

Only battery models in the list can be selected.



**NOTE:**

See step 6, if "Charge from grid for self use" is set to "Not Allow", the inverter will not force charge the battery and the battery could potentially go to sleep mode.

# 5. Commissioning

8. Please check in the accessory package and confirm the meter type first.  
 If the default meter is Acrel ACR10R16DTE, please select the meter type as "1PH Meter".  
 If the default meter is Eastron SDM120CT, please select the meter type as "Eastron 1PH Meter". If another meter is used, please refer to section 6.6.6.3.1 to select the meter type.  
 Please set the "meter placement" as "Grid". If other configuration is used, please refer to section 6.6.6.3.2.

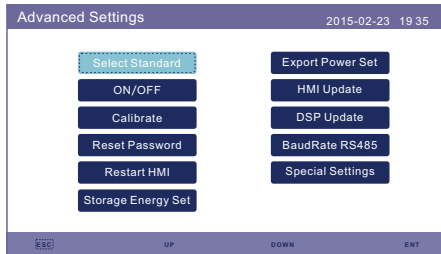

Step 1

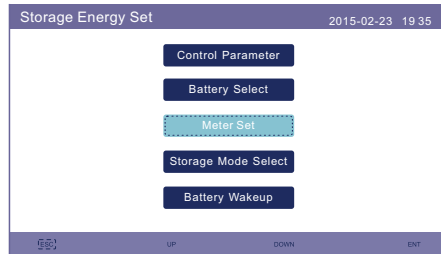

Step 2

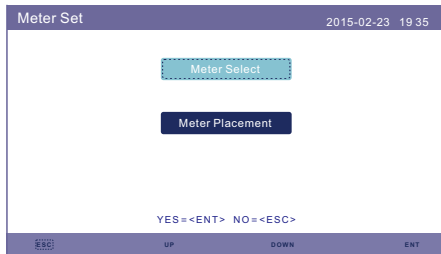

Step 3

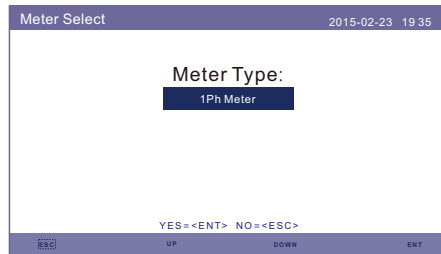

Step 4

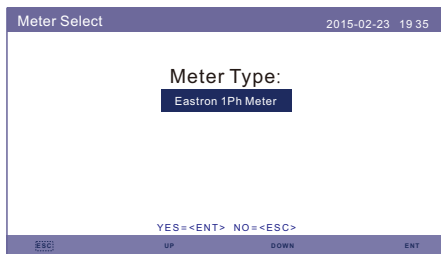

Step 5



Step 6

# 5. Commissioning

9. Switch on the inverter DC switch.  
 10. Switch on battery breaker.  
 11. Verify the readings in "Information" pages.

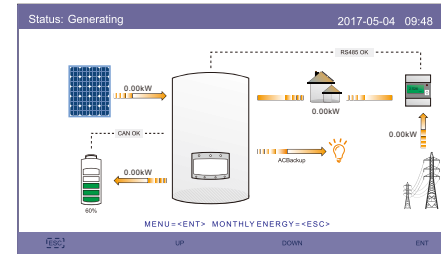

Step 1

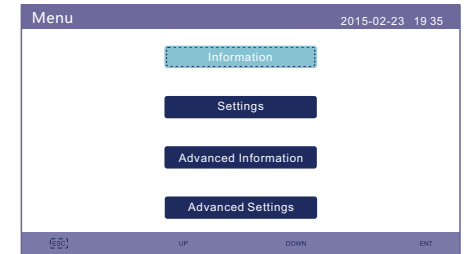

Step 2

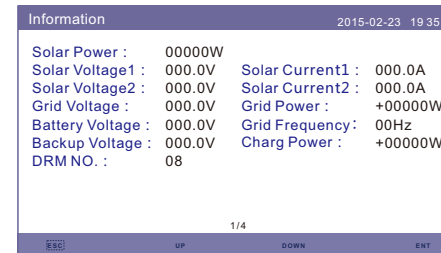

Step 3

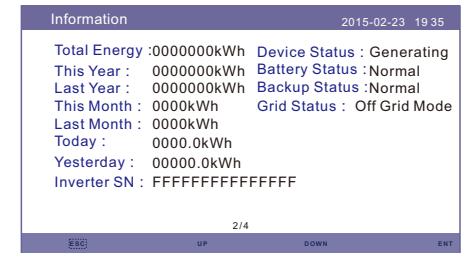

Step 4

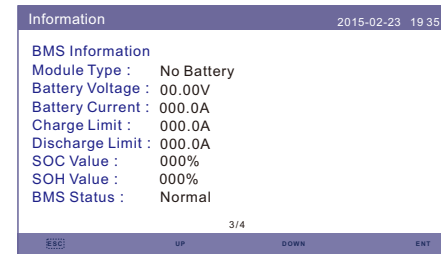

Step 5

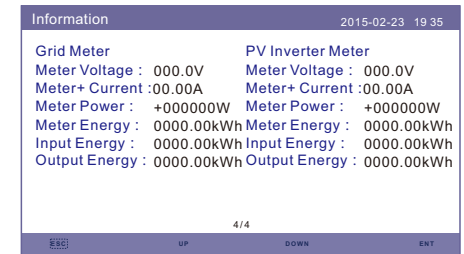

Step 6

## 5.3 Shutdown procedure

1. Turn off the AC isolator at the grid connection point.
2. Turn off the DC switch of the inverter.
3. Turn off the DC switch between inverter and battery.
4. Waiting for the LCD of inverter to turn off and the system shutdown is completed.

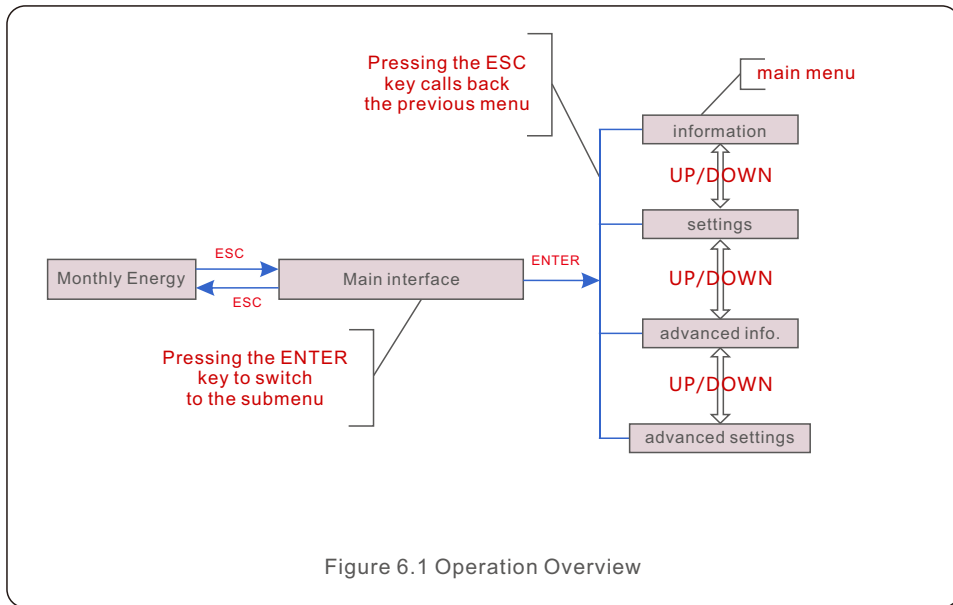

## 6.1 Initial Display

When powering up the inverter for the first time, it is required to set the language. Press "ENT" to select.

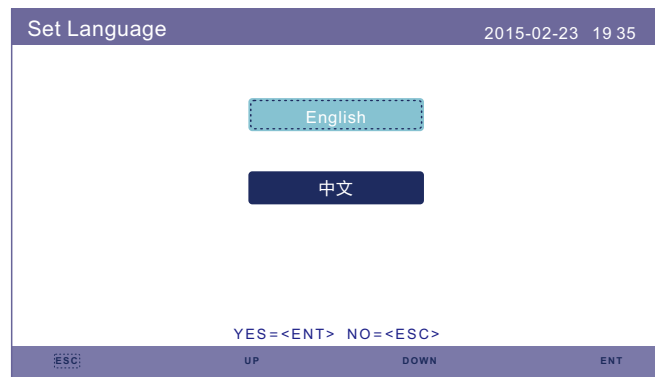

After setting the language, press "ESC" to access the main page.

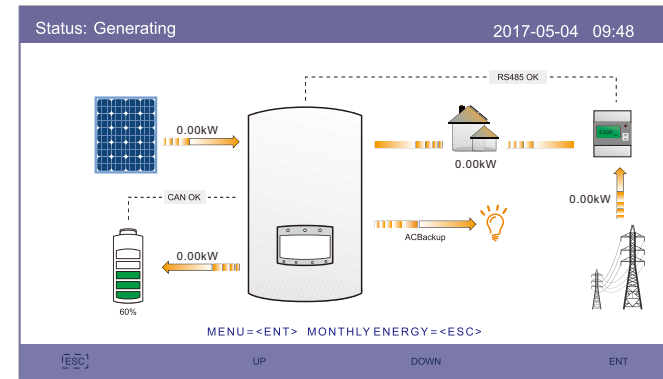

On the main page,  
 Press "ESC" : View the yield data on a monthly bar charts. Then use "UP" and "DOWN" to change the date and "ENT" to move the cursor.  
 Press "UP" or "DOWN": View different status on the top left of the main page.  
 Press "ENT": Enter the main menu.

	Solar Power: When solar power is generated , an arrow indicates the direction of the power flow and the value is shown above the arrow.
	Battery: When the battery is connected successfully, it will display "CAN OK", meanwhile, battery SOC, arrow and value of power flow is shown. Otherwise, it will display "CAN Fail".
	Non-Critical Loads: Loads connected to the AC Grid port which will shutdown if the grid is in malfunction.
	Smart Meter: When the smart meter is connected successfully, it will display "RS485 OK", otherwise "RS485 Fail".
	Critical Loads: Loads connected to the AC Backup port which will be supported by battery and solar even if the grid is in malfunction.
	Grid: The arrow and value indicate the export/import power of the hybrid system.



## 6.2 Main Menu

There are four submenu in the Main Menu:

1. Information
2. Settings
3. Advanced Information
4. Advanced Settings

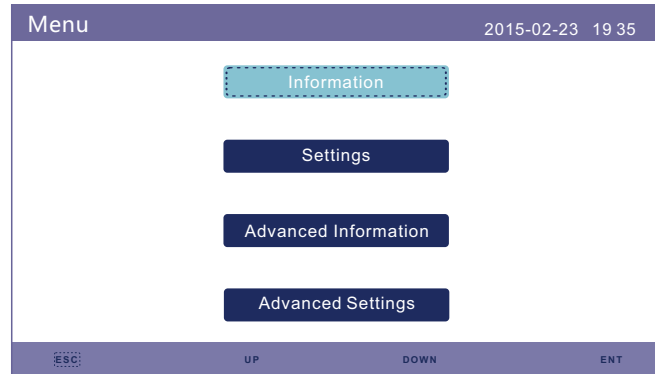

Figure 6.4 Main Menu

## 6.3 Information

In the "Information" section, operating data and information can be viewed.

Three pages of information can be checked by press "UP" or "DOWN".

The example display is shown in the following Figure 6.5, 6.6 and 6.7.

Values are for reference only.

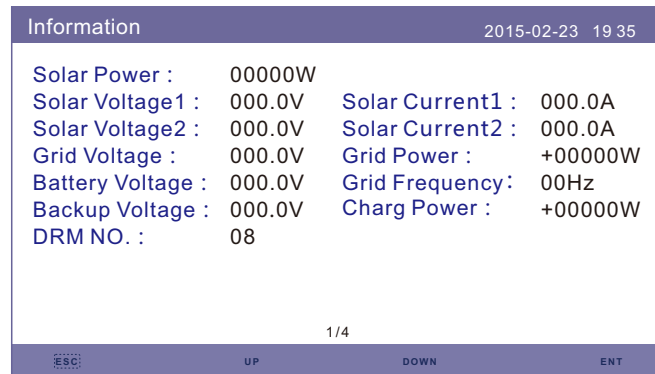

Figure 6.5 Information Page 1

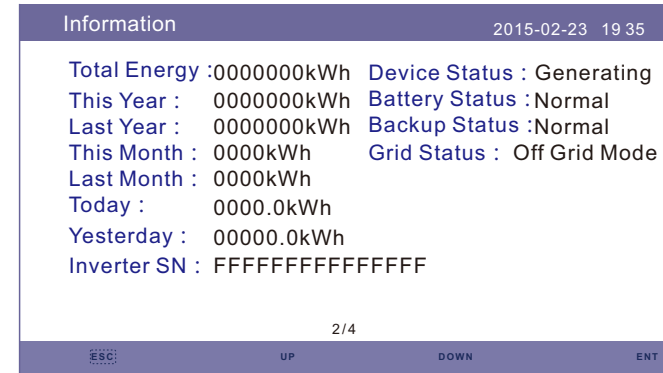

Figure 6.6 Information Page 2

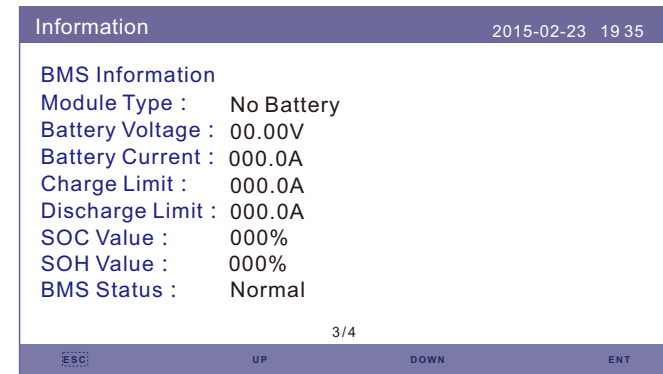

Figure 6.7 Information Page 3

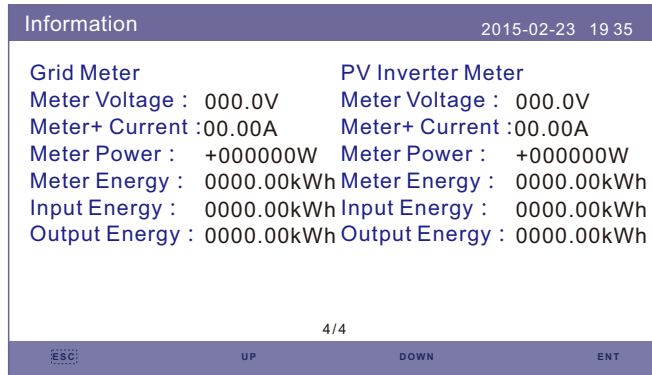

Figure 6.8 Information Page 4



**NOTE:**

Meter Power/Grid Power: Positive value indicates exporting power to the grid, negative value indicates importing power from the grid  
 Charge Power: Positive value indicates charging, negative value indicates discharging.



**NOTE:**

Information for "PV Inverter Meter" is only available when two Eastron meters are used and Meter Placement is selected as "Grid+PV Meter".  
 Details please consult Solis service department.

## 6.4 Settings

In the "Settings" section, Time/Date, Slave address and language can be modified.

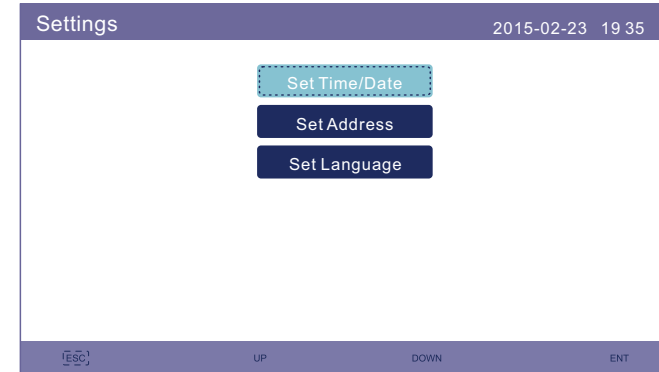

Figure 6.9 Setting

### 6.4.1 Set Time/Date

Set the time and date on the inverter. Must set this according to local time as it affects the daily yield calculation. (If Solis monitoring system is used, must set the correct time zone of the system, otherwise datalogger will update the inverter time based on the time zone of the system.)

Press "UP" and "DOWN" to change the value.

Press "ENT" to move the cursor.

Press "ESC" to save the change.

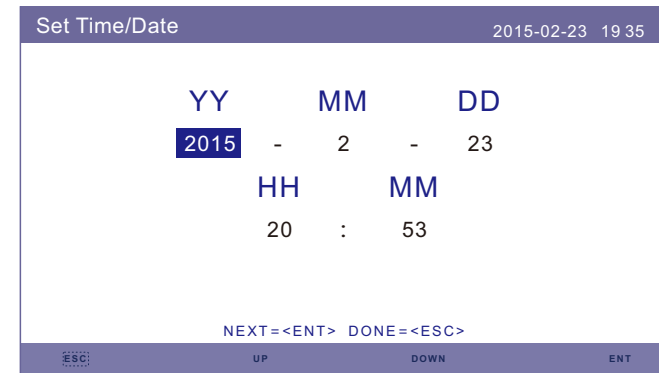

Figure 6.10 Set Time

# 6. Operation

## 6.4.2 Set Address

Set the slave address of the inverter. The default address is 01.



Figure 6.11 Set Address

## 6.4.3 Set Language

Set system language. Chinese and English are available.

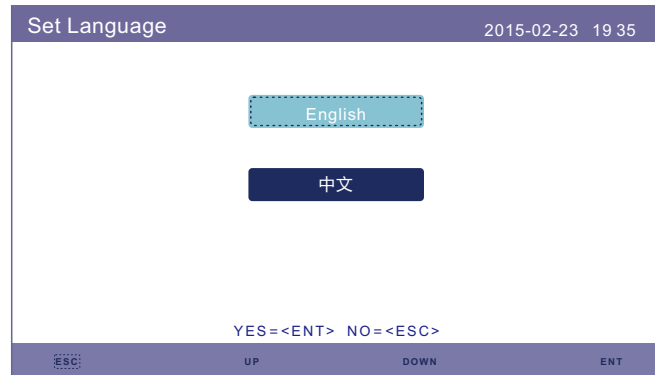

Figure 6.12 Set Language

# 6. Operation

## 6.5 Advanced Information

Detailed information can be viewed in this section:

1. Alarm Message
2. Running Message
3. Version
4. Communication Data.
5. Daily Energy
6. Monthly Energy
7. Yearly Energy
8. Total Energy.
9. Warning Message

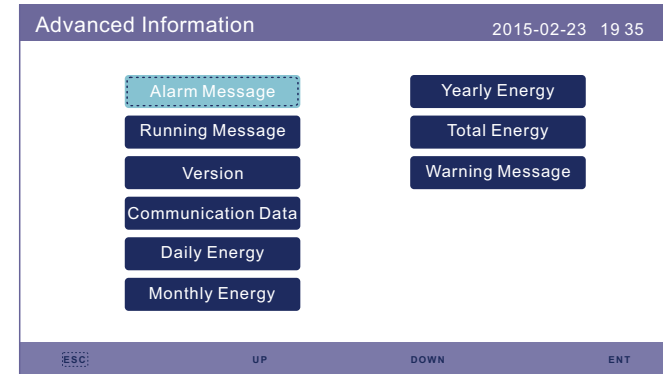

Figure 6.13 Advanced Information

### 6.5.1 Alarm Message

40 pages of latest alarm messages (5 per page). Alarm message shows the alarm that will lead to inverter shutdown.

The screenshot shows a menu titled 'Alarm Message' with a timestamp '2015-02-23 19:35'. The main display area contains a table with three columns: 'Message', 'Date/Time', and 'Date'. The table lists five 'NO-Grid' alarm messages. At the bottom, there are navigation options: 'UP', 'DOWN', and 'ENT' on the right, and an 'ESC' icon on the left side of the bottom bar.

Message	Date/Time	Date
NO-Grid	02-23 19:35	0000
NO-Grid	02-23 19:34	0000
NO-Grid	02-23 19:34	0000
NO-Grid	02-23 19:24	0000
NO-Grid	02-23 18:22	0000

01/40

Figure 6.14 Alarm Message

# 6. Operation

## 6.5.2 Running Message

This function is for maintenance person to get running message such as internal temperature, Standard NO. etc.(Values are for reference only).

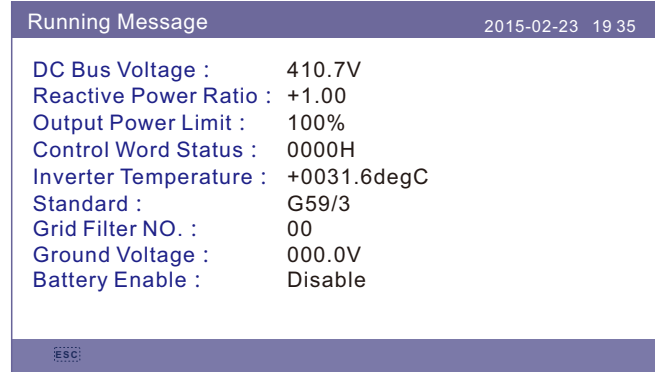

Figure 6.15 Running Message

## 6.5.3 Version

Inverter model number and software version can be viewed in this section. Values are for reference only..



Figure 6.16 Model Version and Software Version

# 6. Operation

## 6.5.4 Communication Data

Internal communication data can be viewed in this section. For maintenance person only. Values are for reference only.

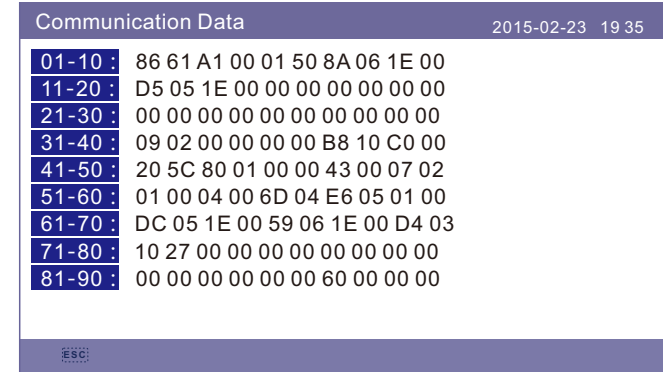

Figure 6.17 Communication Data

## 6.5.5 Daily Energy

The screen shows the daily energy detail of the inverter.

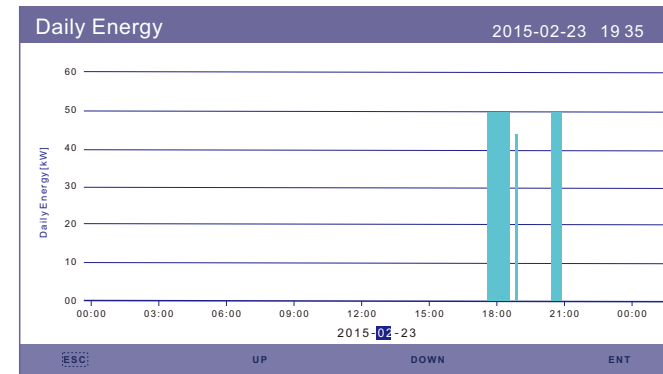

Figure 6.18 Daily Energy

# 6. Operation

# 6. Operation

## 6.5.6 Monthly Energy

The screen shows the inverter monthly energy detail of different month.

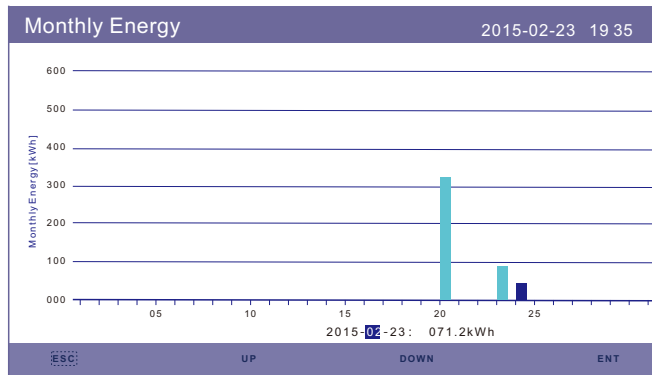

Figure 6.19 Monthly Energy

## 6.5.7 Yearly Energy

The screen shows the inverter yearly energy detail of different year.

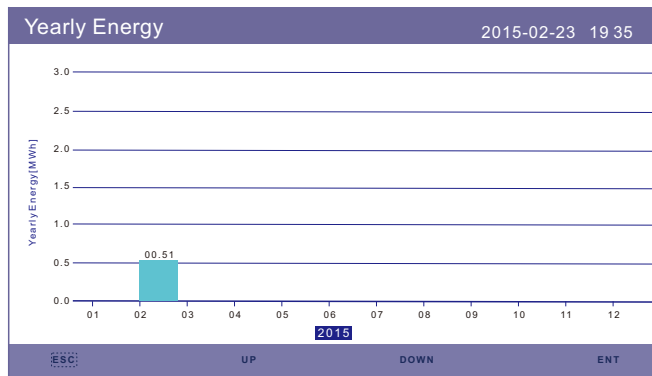

Figure 6.20 Yearly Energy

## 6.5.8 Total Energy

The screen shows the inverter total energy detail.

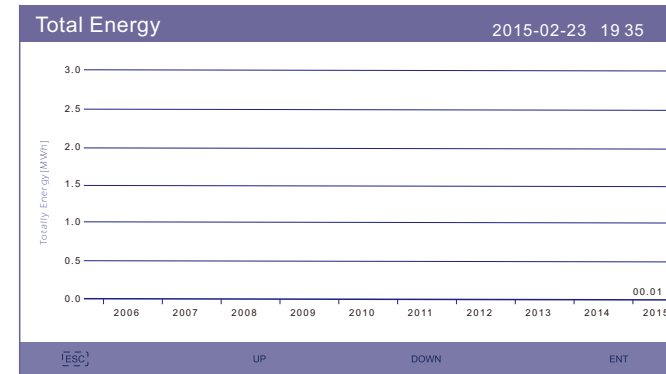

Figure 6.21 Total Energy

## 6.5.9 Warning Message

10 pages of latest warning messages (5 per page).

Warning message shows the warning that is abnormal but will not lead to inverter shutdown.

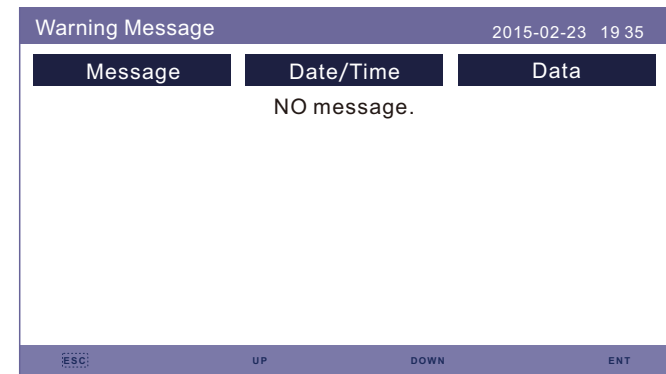

Figure 6.22 Warning Message

## 6.6 Advanced Settings - Technicians Only



**NOTE:**

This function is for authorised technicians only. Improper access and operation may result in abnormal results and damage to the inverter. Password required – restricted access – authorised technicians only. Un-authorised access may void the warranty. (Password"0010")

Select Advanced Settings from main menu, the LCD screen show the password is needed:

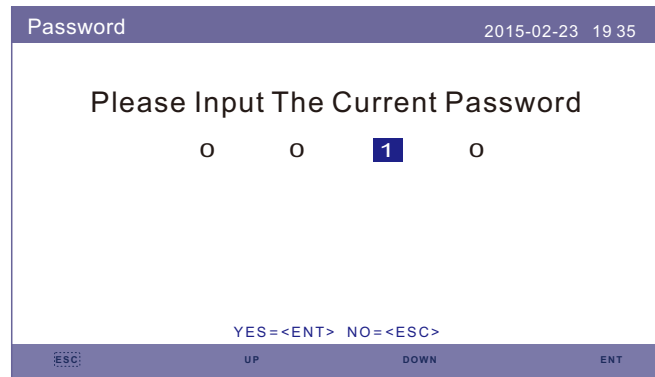

Figure 6.23 Enter Password

The default password is "0010".

Please press "down" to move the cursor, press "up" to select the number.

After enter the correct password the Main Menu will display a screen and be able to access to the following information.

1. Select Standard
2. ON/OFF
3. Calibrate
4. Reset Password
5. Restar HMI
6. Storage Energy Set
7. Export Power Set
8. HMI Update
9. DSP Update
10. BaudRate RS485
11. Special Settings

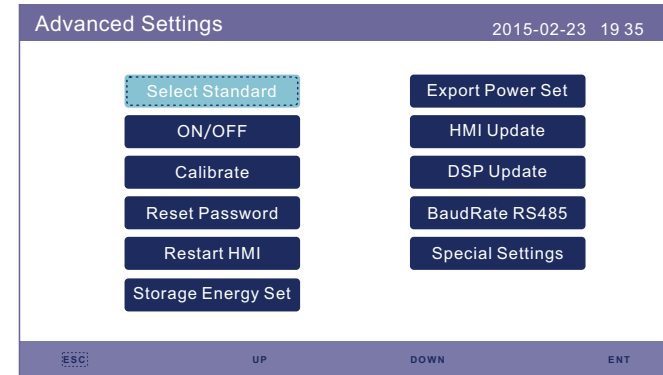

Figure 6.24 Advanced Settings

### 6.6.1 Select Standard

This function is used to select corresponding grid standards.

Please refer to the actual LCD setting for the grid standard options.



Figure 6.25 Select Standard

Press "UP" and "DOWN" to go through the list.

Press "ENT" to check the parameters, press "ENT" again to select the standard.



**NOTE:**

Please check if the grid code setting comply with local requirement.

For different countries and regions, corresponding grid code needs to be selected in the inverter LCD to meet the requirements of local network provider.

This instruction indicates how to change the grid code and what code should be selected in different places.

This following list illustrates the grid standard options in the inverter which are subject to change. It is for your reference only. If customer has any doubts or uncertainty, please consult Solis service department for confirmation.

Detailed protection limits can be viewed when choosing the code.  
Please select "Save&Send" to enforce the code.

NO.	Code in LCD	Applicable Country/Region
1	VDE4015	Germany
2	DK1	East Denmark
3	DK2	West Denmark
4	EN50438L	Applicable in some European countries
5	France	France
6	C10/11	Belgium
7	NRS097	South Africa
8	CEI-021	Italy
9	RD1699	Spain
10	EN50549	Applicable in some European countries
11	G98	UK
12	G99	UK
13	G98NI	North Ireland
14	G99NI	North Ireland
15	EN50549IE	Ireland

Table 6.1 Applicable Country/Region

## 6.6.2 ON/OFF

This function is used to start or stop the generation of the inverter.

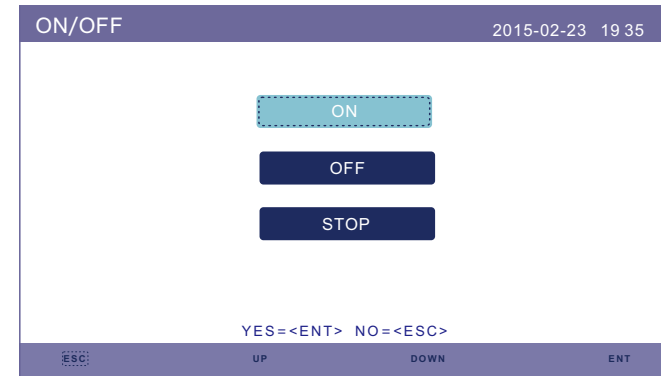

Figure 6.26 Set ON/OFF

## 6.6.3 Calibrate

Warranty or maintenance may result in resetting total generating data, this function allow the maintenance personnel to amend the total generating data of replacement inverter to the original one.

By using our data monitoring hardware, the data on monitoring website can automatically synchronize with the preset total generating power of inverter.

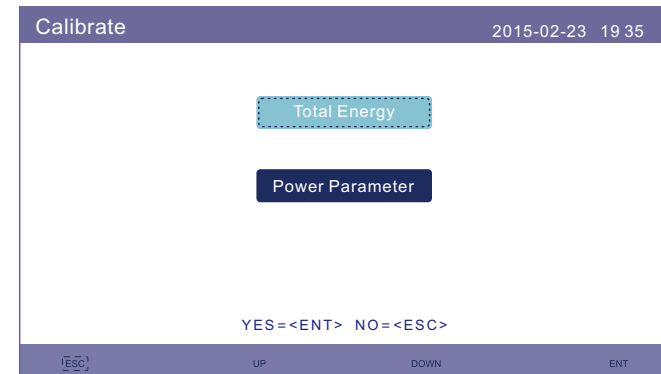

Figure 6.27 Calibrate

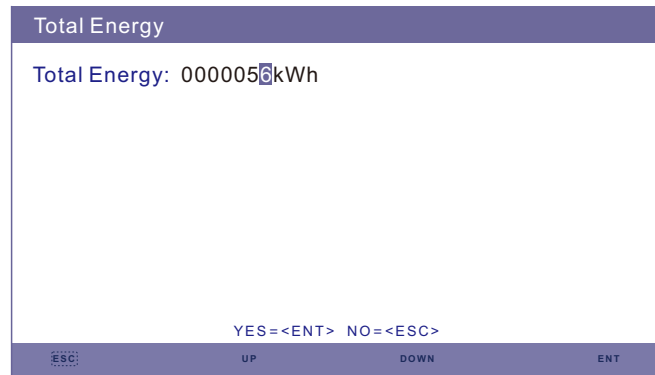

Figure 6.28 Total Energy

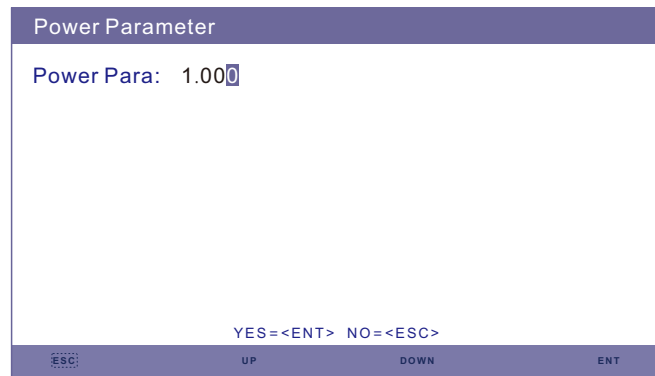

Figure 6.29 Power Parameter

## 6.6.4 Reset Password

Reset Password: In this page, user can reset the inverter password, but the admin password is always valid.



Figure 6.30 Reset Password

## 6.6.5 Restart HMI

This function is to reboot the LCD screen.

## 6.6.6 Storage Energy Set

This section contains working mode setting, battery control setting, etc.

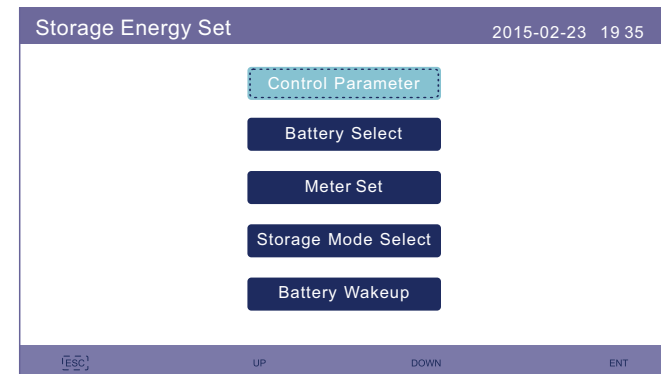

Figure 6.31 Storage Energy set



## 6.6.6.1 Control Parameter

Enter the Control Parameter menu as shown below:  
Don't change the settings without the permission of technicians.

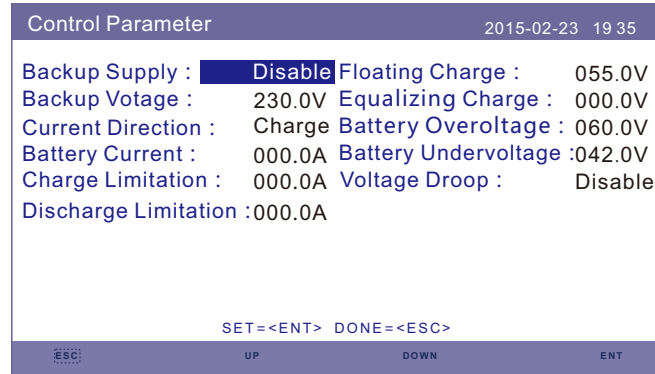

Figure 6.32 Control Parameter

## 6.6.6.2 Battery Select

This product is compatible with multiple battery models. Please refer to the latest compatible battery list on Solis company website.



### WARNING:

Inverter must be installed with compatible battery models. Any defect, damage or collateral loss due to using a non-compatible battery is not in the scope of inverter warranty or compensation. Please refer to the battery compatible list on Solis company website for information on latest compatible battery models.

For above compatible battery modules, Only three parameters need to be defined:

- \* OverDischg SOC (10%~40%, default 20%)
  - Inverter will not discharge the battery when the OverDischg SOC is reached.
  - Battery self-discharge is unavoidable, SOC may go lower than the limit if the battery can't get charged for a long period of time.
- \* ForceCharge SOC (5%~OverDischg SOC, default 10%)
  - To prevent the battery going into sleep mode, when the ForceCharge SOC is reached, inverter will charge the battery using the power from either PV or Grid.
- \* ForceChg Limit (0A~100A, default 100A)
  - Determine the battery charge current limit when inverter operates in force charge status.

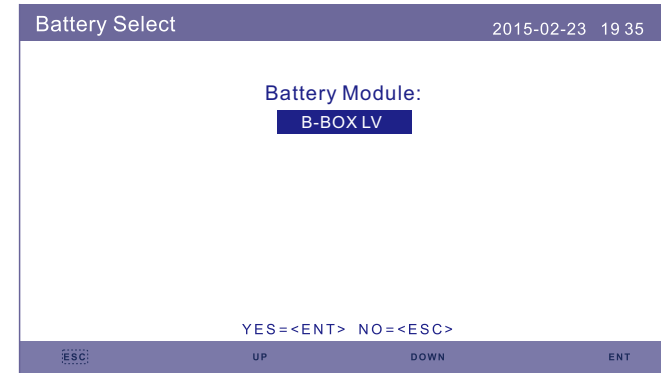

Figure 6.33 Battery Select

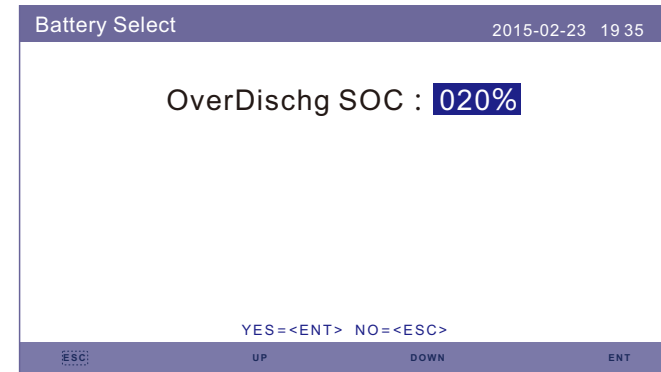

Figure 6.34 Over Discharge SOC.

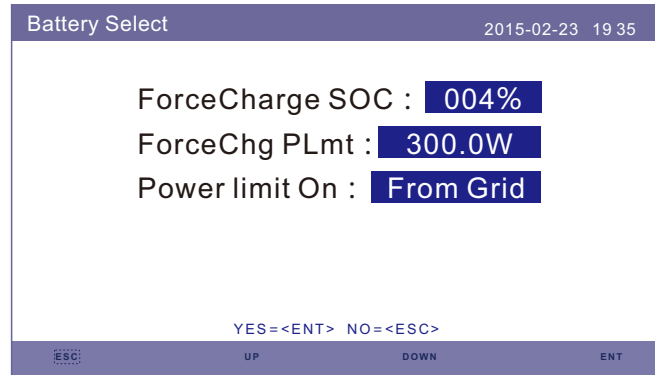

Figure 6.35 ForceCharge SOC



**NOTE:**

1. Under force charging, to avoid severe battery overdischarging and protect battery life, the priority of force charging is higher than the control of "not allow power from the grid".
2. In Backup mode, if the current battery SOC is less than the set value (reserved SOC-2), force charge is required to ensure that the battery has sufficient SOC. In this case, the priority of force charge is higher than the control of "not allow power from the grid".
3. In charging period of other modes, control of "not allow power from the grid" takes precedence over charging requirements.



**NOTE:**

5G products support lead-acid battery. Select "Lead-Acid" in the "Battery Select" and configure the following parameters according to different lead-acid batteries.

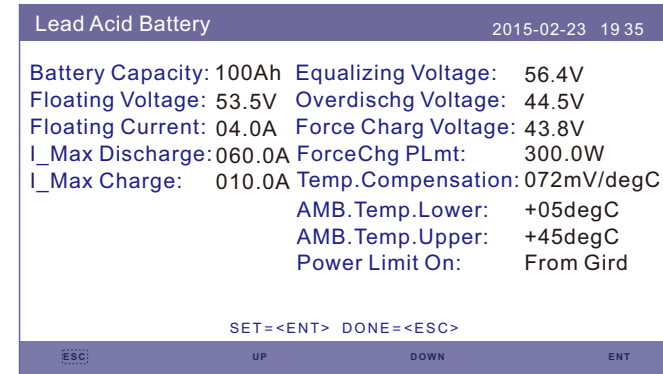

Lead Acid Battery (Values are examples Only)

1. Battery Capacity: Define the capacity of the battery.
2. Equalizing Voltage: Define the voltage for Equalizing/Absorption charge.
3. Floating Voltage: Define the voltage for floating charge.
4. Floating Current: Define the current for floating charge.
5. Overdischg Voltage: Define the voltage that stops discharging the battery.
6. Force Charge Voltage: Define the voltage that forces to charge the battery to prevent a dead battery.
7. ForceChg Limit: Define the battery charge current limit in force charge status.
8. I\_Max Discharge: Define the max discharge current for the battery.
9. I\_Max Charge: Define the max charge current for the battery.
10. Temp.Compensation: Define the temperature compensation parameter for the battery.
11. AMB.Temp.Lower/Upper: Define the temperature range when the temperature compensation is effective.

After configuration, save and send.

If battery temperature sensor is connected, select "Warm".

If battery temperature sensor is not connected, select based on actual condition for fixed compensation

**Cold: 5 degC Warm: 25 degC Hot: 40 degC**

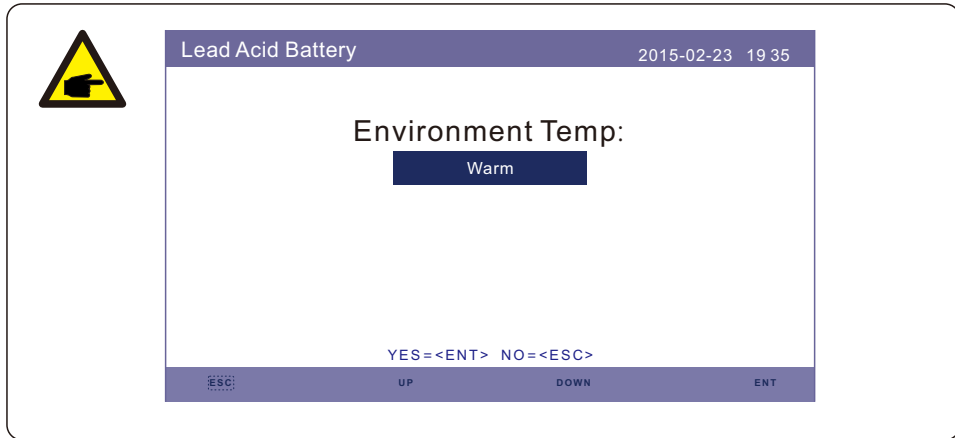

**WARNING:** Lead-acid battery is not recommended for general customers as it requires experienced installers and technicians who can fully understand the battery parameters and configure the settings and installations correctly. Due to the inconformity between battery cells, damages will be less likely to be avoided. Solis is not responsible for any potential damages caused by the use of lead-acid batteries.

## 6.6.6.3 Meter Set

These settings are used to select the meter types and meter installed locations based on the actual configuration.

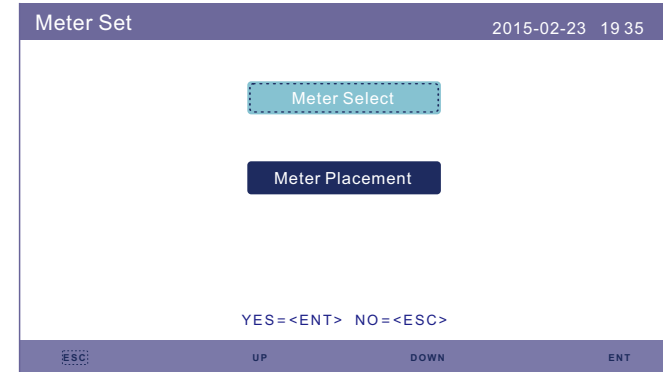

Figure 6.36 Meter Set

### 6.6.6.3.1 Meter Select

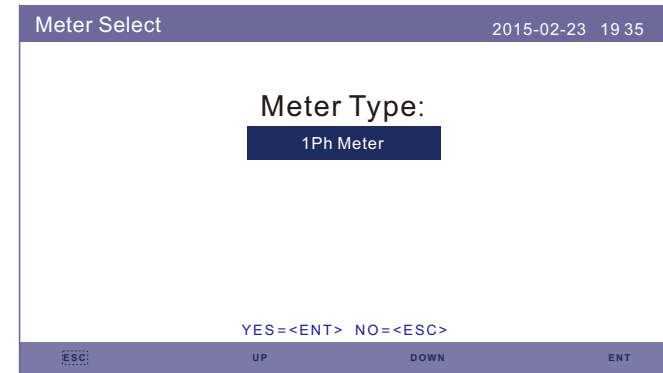

Figure 6.37 Meter Select

Meter Model	Meter Type Options
Acrel 1ph meter (With CT): ACR10R-D16TE (Optional)	"1ph meter"
Acrel 3ph meter (With CT): ACR10R-D16TE4 (Optional)	"Acrel 3ph meter"
Eastron 1ph meter (Direct Insert): SDM120M (Optional)	"Eastron 1ph meter"
Eastron 1ph meter (With CT): SDM120CT	"Eastron 1ph meter"
Eastron 3ph meter (Direct Insert): SDM630 (Optional)	"Eastron 3ph meter"
Eastron 3ph meter (With CT): SDM630MCT (Optional)	"Eastron 3ph meter"
No meter is connected	"No Meter"

# 6. Operation

## 6.6.6.3.2 Meter Placement

Grid: Meter is installed at the grid connection point.  
 Load: Meter is installed at the load branch circuit.  
 Grid+PV Inverter: One meter is connected at the grid connection point, the other meter is connected at the AC output port of an extra PV inverter. (Eastron Meter supported).



Figure 6.38 Meter Placement

## 6.6.6.4 Storage Mode Select

There are 4 working modes available.  
**1. Self Use Mode 2. Feed in Priority Mode 3. Backup Mode 4. Off Grid Mode**

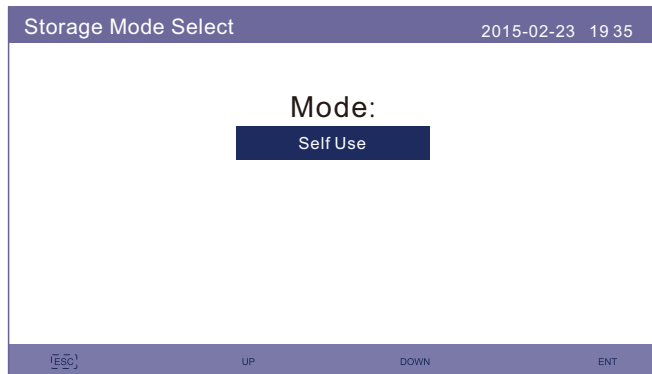

Figure 6.39 Storage Mode Select

# 6. Operation

## Mode 1: Self-Use Mode Logic(Maximize the usage of PV)

PV Power Using Priority: Load>Battery>Grid  
 Load Support Priority: PV>Battery>Grid  
 Battery Charging Power comes from PV. (If "Charging From Grid" is allowed, it can also come from Grid)  
 If "Time of Use" is "Run", the logic will follow the charging/discharging settings and time settings as defined in "Time of Use". For those undefined period of time, it will still follow the Self-Use logic.

### Time of use for Self use

Path: Advanced Settings-> Storage Energy Set-> Storage Mode Select-> Self-Use Mode->ON-> Time of use for Self use

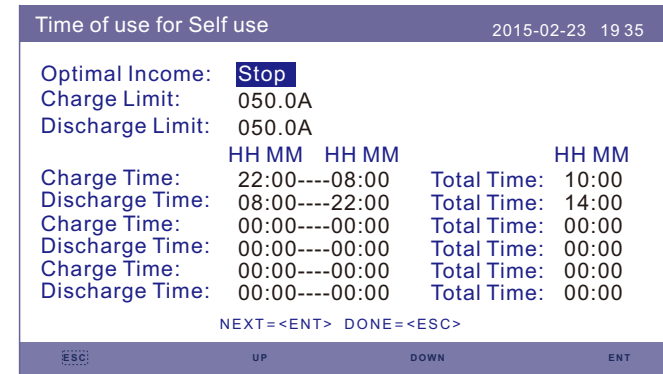

Figure 6.40

### Charging from gird self use

Path: Advanced Settings-> Storage Energy Set-> Storage Mode Select-> Self-Use Mode->ON-> Charging from gird for Self use



Figure 6.41

# 6. Operation

## Mode 2: Feed In Priority Mode Logic(Feed the excess PV to Grid in order to gain subsidies)

PV Power Using Priority: Load>Grid>Battery

Load Support Priority: PV>Battery>Grid

Battery Charging Power comes from PV. (If "Charging From Grid" is allowed, it can also come from Grid)

If "Time of Use" is "Run", the logic will follow the charging/discharging settings and time settings as defined in "Time of Use". For those undefined period of time, it will still follow the Feed in Priority logic.

### Time of use for Feed for priority

Path: Advanced Settings->Storage Energy Set->Storage Mode Select->Feed in Priority Mode->ON->Time of use for Feed for priority

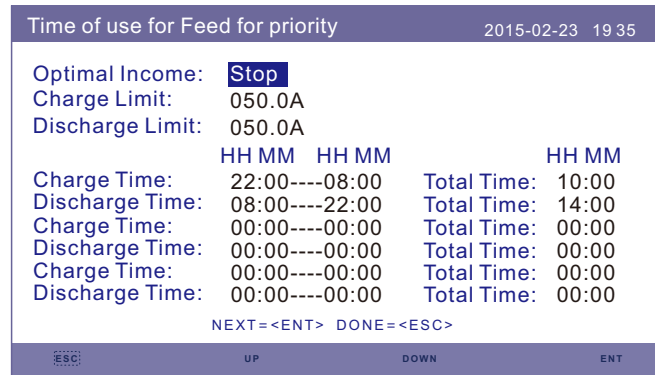

Figure 6.42

### Charging from grid for Feed for priority

Path: Advanced Settings->Storage Energy Set->Storage Mode Select->Feed in Priority Mode->ON->Charging from grid for Feed for priority

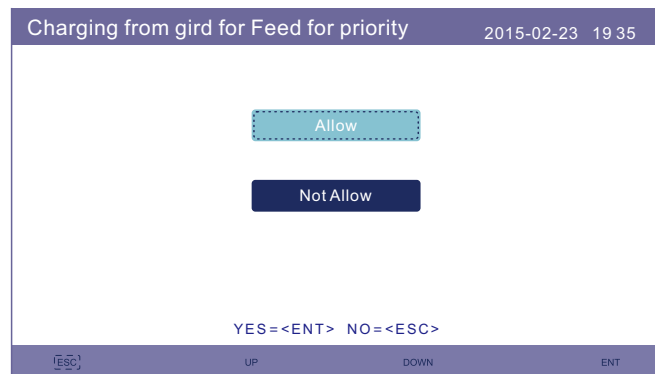

Figure 6.43

# 6. Operation

## Mode 3: Backup Mode Logic(Keep the Battery at a certain SOC and only use it during power outage)

Backup Mode Logic: Keep the Battery at a certain SOC and only use it during power outage.

Backup SOC Setting Range: From Battery "Overdischarge SOC" to 100%

PV Power Using Priority: Battery>Load>Grid

Load Support Priority: PV>Grid>Battery

Battery Charging Power comes from PV. (If "Charging From Grid" is allowed, it can also come from Grid)

\* The "Backup Mode" is not applicable for Lead-acid batteries.

### Charging from grid for Backup mode

Path: Advanced Settings->Storage Energy Set->Storage Mode Select->Backup Mode->ON->Backup SOC->Charging from grid for Backup mode

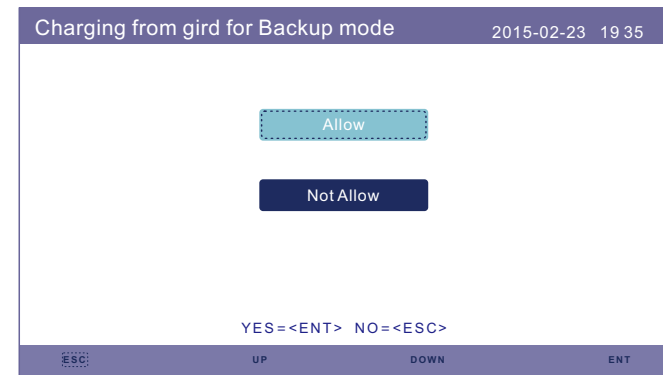

Figure 6.44

# 6. Operation

# 6. Operation

## Mode 4: Off-Grid Mode Logic(For Off-grid use and AC-Grid Port Disconnected)

OverDischg SOC for Off-Grid Setting Range: From Battery "Forcecharge SOC" to 100%

PV Power Using Priority: Load>Battery

Load Support Priority: PV>Battery

Battery Charging Power comes from PV.

### Off Grid Mode

Path: Advanced Settings->Storage Energy Set->Storage Mode Select->Off-Grid Mode->ON->Off Grid Mode

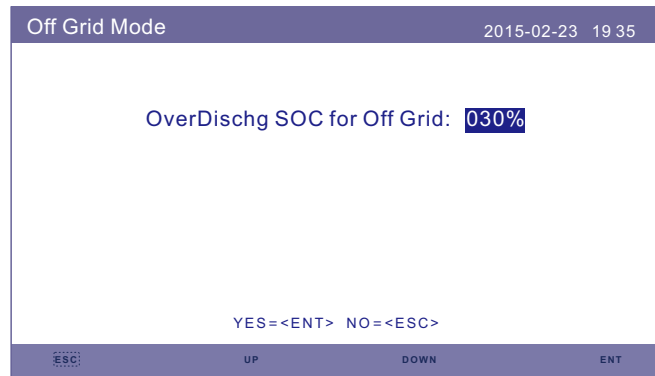

Figure 6.45

### 6.6.6.5 Battery Wakeup

This function should be activated only after the installation. In the case of a low battery voltage shutdown, the inverter will shut-down. This setting can be enabled, so when the inverter detects PV or grid it wakes up the battery. This function conflicts with the battery reverse polarity protection( If the installer connects cables with wrong polarity, the inverter can protect itself from damage).To avoid the possible damage during installation, do not active battery wakeup function before finishing the first commissioning.

## 6.6.7 Export power Set

This function is to set the export power control.

### 1. ON/OFF. 2.Backflow Power. 3.FailSafe ON/OFF

Setting 2&3 are only valid when Setting 1 is set to "ON"

"ON/OFF" is to enable/disable the export power control function

"Backflow Power" is to set the max allowed export power at the meter location

"FailSafe ON/OFF" is a protection method to prevent excess export power when meter communication fails

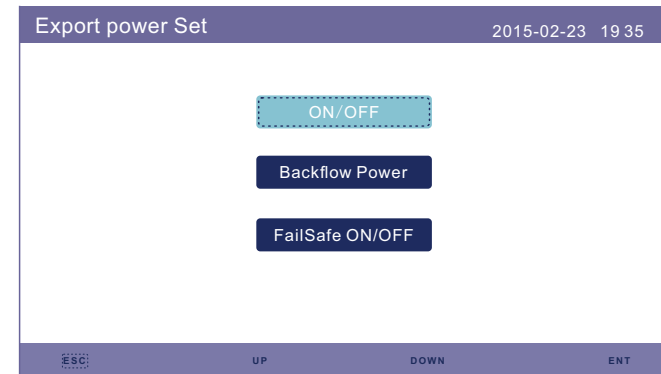

Figure 6.46 Export power Set

### 6.6.7.1 ON/OFF

Enable/Disable the function.

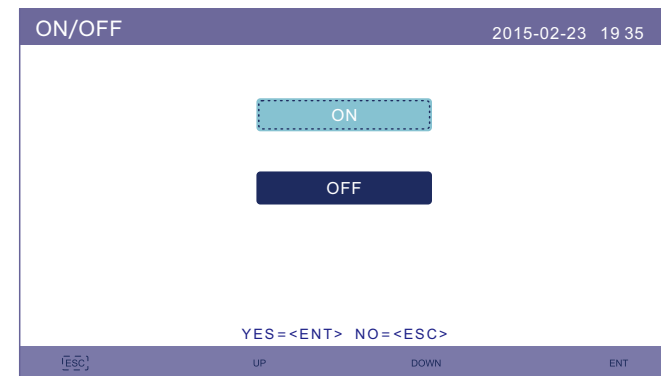

Figure 6.47 ON/OFF

# 6. Operation

## 6.6.7.2 Backflow Power

Determine the allowed backfeed power. (System export to the grid)

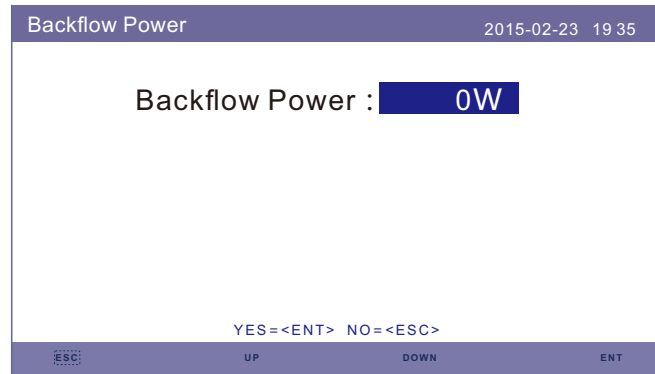

Figure 6.48 Backflow Power

## 6.6.7.3 FailSafe ON/OFF

When this Failsafe function is ON, the inverter will shutdown once it loses communication with the meter in case of any backflow power exceeding the limit.

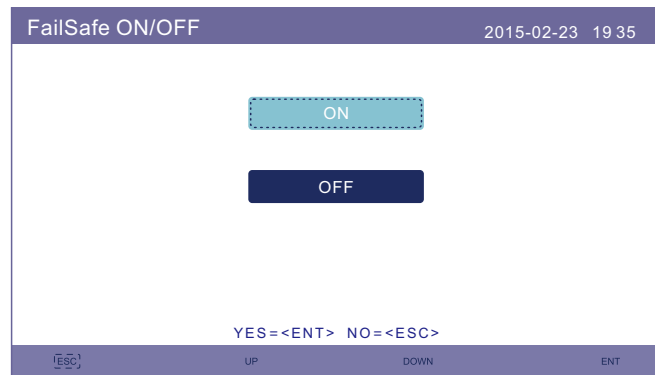

Figure 6.49 FailSafe ON/OFF

# 6. Operation

## 6.6.8 HMI Update

This function is used to update HMI software. Values are for reference only.

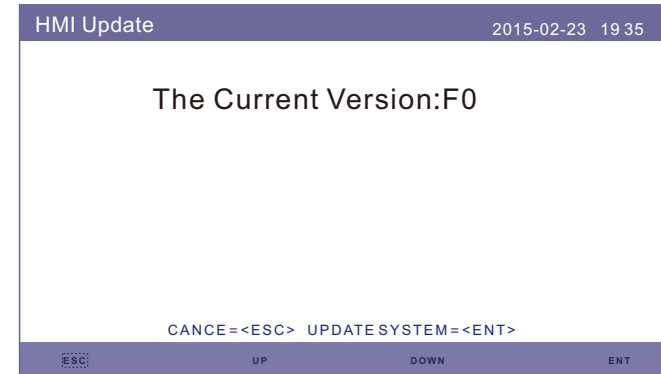

Figure 6.50 HMI Update

## 6.6.9 DSP Update

This function is used to update DSP software. Values are for reference only.

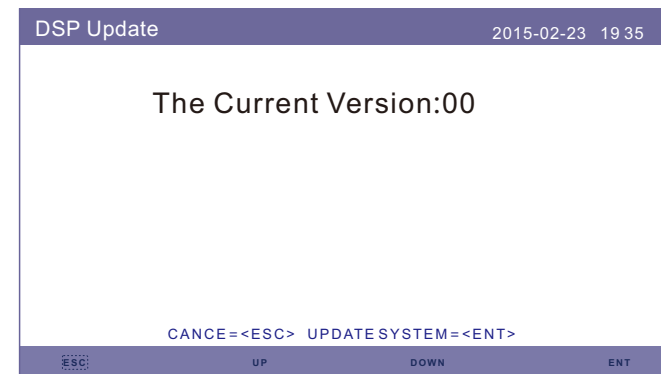

Figure 6.51 DSP Update

# 6. Operation

# 6. Operation

## 6.6.10 BaudRate RS485

This function is to change the internal communication Baudrate.

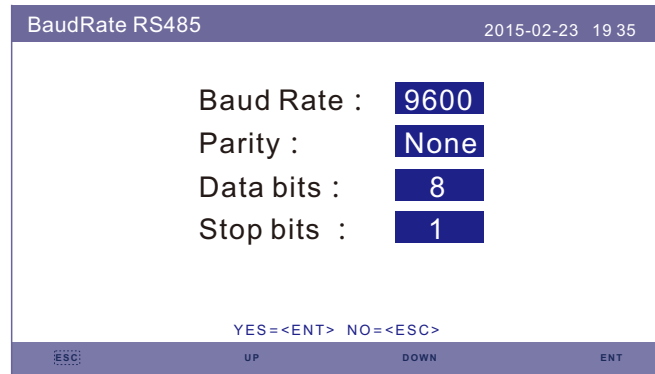

Figure 6.52 BaudRate RS485



**WARNING:**

This function is for maintenance personnel only, wrong operation will prevent the inverter from working properly.

## 6.6.11 Special Setting

There are two special settings:

- 1. AFCI Set
- 2. EPS Mode



Figure 6.53 Special Setting

## 6.6.11.1 AFCI Set

Inverters have the built-in AFCI function which can detect the arc fault on the DC circuit and shut down the inverter to prevent a fire disaster.



Figure 6.54 AFCI Set



**WARNING:**

The "AFCI Level" is reserved for technicians ONLY. Do not change the sensitivity otherwise it will lead to frequent false alarms or malfunctions. Manufacturer is not responsible for any further damages caused by unauthorized modifications.



**WARNING:**

The setting corresponds to the current status as well which can be used to inspect the ON/OFF state of the AFCI function.



During the normal operation, if an DC arc is detected, the inverter will shut down and give out the following alarm:



Figure 6.55 ARC-FAULT

Installer needs to thoroughly inspect the DC circuit to ensure all the cables are correctly fastened.

Once the DC circuit issue has been fixed or it is confirmed to be OK, press "ESC" for 3s and wait for the inverter to restart.

## 6.6.11.2 EPS Mode

EPS Mode needs to work with external Solis NPS switching box to achieve ATS switching function.

When grid is available, only the Grid Port is enabled and load is supported through NPS box by the grid.

When grid is lost, Grid Port will be disabled and after the "Switching Time", the Backup Port will be enabled and then load is supported through NPS box by the Backup Port.

\*It gives up the UPS function of the backup port and manually set the switching time.

This mode must work with the Solis NPS switching Box.

Otherwise it may cause some unexpected control mistakes.

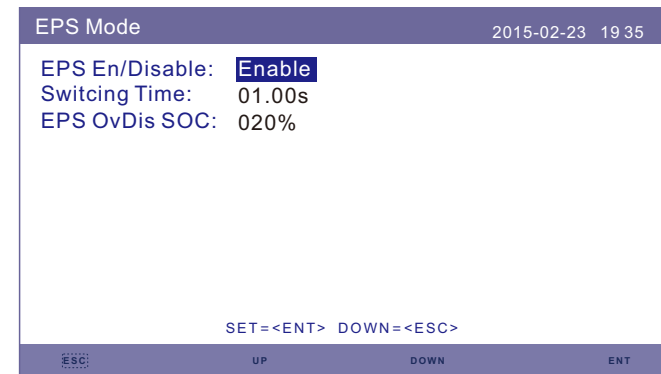

Figure 6.56 EPS Mode

# 7. Maintenance

Solis S5-EH1P-L Series inverter does not require any regular maintenance. However, cleaning the heatsink will help inverter dissipating heat and increase the lifetime of inverter. The dirt on the inverter can be cleaned with a soft brush.



**CAUTION:**

Do not touch the surface when the inverter is operating. Some parts may be hot and cause burns. Turn OFF the inverter (refer to Section 5.2) and let it cool down before you do any maintenance or cleaning of inverter.

The LCD and the LED status indicator lights can be cleaned with cloth if they are too dirty to be read.



**NOTE:**

Never use any solvents, abrasives or corrosive materials to clean the inverter.

# 8. Troubleshooting

The inverter has been designed in accordance with international grid tied standards for safety, and electromagnetic compatibility requirements. Before delivering to the customer the inverter has been subjected to several test to ensure its optimal operation and reliability.

In case of a failure the LCD screen will display an alarm message. In this case the inverter may stop feeding energy into the grid. The alarm descriptions and their corresponding alarm messages are listed in Table 8.1:

When faults occur, the "Fault" state will be shown on the main screen. Follow the steps below to check what fault occurs.

Steps: Enter → Down → Advanced Information → Enter → Alarm Message.

Step1: Press ENTER.

Step2: Press DOWN to select Advanced Information, then press ENTER.

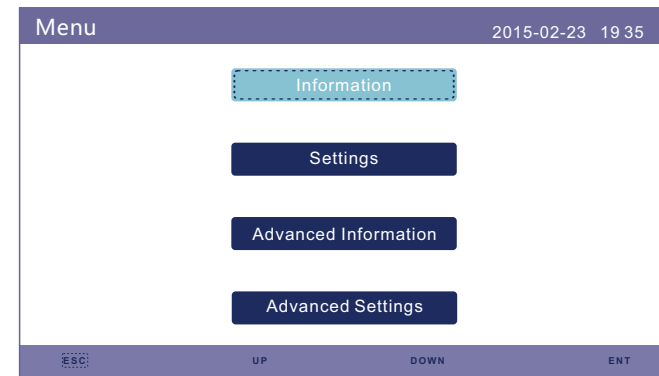

Step3: Press DOWN to select Alarm Message, then press ENTER.

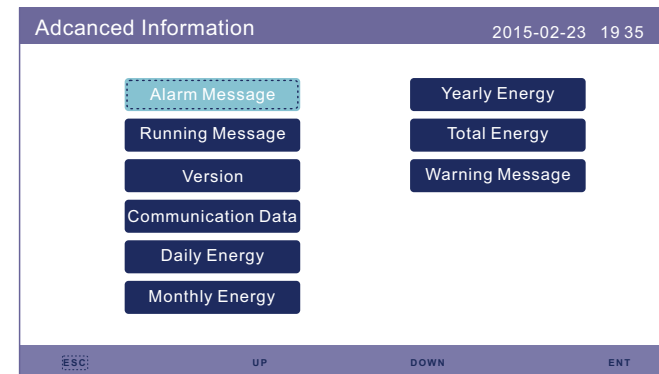

# 8. Troubleshooting

Message Name	Information Description	Troubleshooting Suggestion
Off	Control device to shutdown	1. Turn on the device in the ON/OFF Setting.
LmtByEPM	The device's output is under controlled	1. Confirm whether the inverter is connected to an external EPM/meter to prevent reverse current. 2. Confirm whether the inverter is controlled by an external third-party device. 3. Confirm whether the power setting of the inverter power control is limited. 4. Verify settings in section 6.6.7 and check your meter readings.
LmtByDRM	DRM Function ON	1. No need to deal with it.
LmtByTemp	Over temperature power limited	1. No need to deal with it, the device is in normal operation.
LmtByFreq	Frequency power limited	
LmtByVg	The device is in the Volt-Watt mode	1. Due to the requirements of local safety regulations, when the grid voltage is high, the Volt-watt working mode is triggered, which generally does not need to be dealt with. 2. Inverter factory test errors causing this mode to open, if you need to close, you can close this mode in LCD, set the process: Main menu → Advanced Settings → Password 0010 → STD mode settings → Working Mode → Working mode: NULL → Save and exit.
LmtByVar	The device is in the Volt-Var mode of operation	1. Due to the requirements of local safety regulations, when the grid voltage is high, the Volt-watt working mode is triggered, which generally does not need to be dealt with. 2. Inverter factory test errors causing this mode to open, if you need to close, you can close this mode in LCD, set the process: Main menu → Advanced Settings → Password 0010 → STD mode settings → Working Mode → Working mode: NULL → Save and exit.
LmtByUnFr	Under frequency limit	1. No need to deal with it.
Standby	Bypass run	
StandbySynoch	Off grid status to On grid status	
GridToLoad	Grid to load	

# 8. Troubleshooting

Message Name	Information Description	Troubleshooting Suggestion
Surge Alarm	On-site grid surge	1. Grid side fault, restart the device. If it is still not eliminated, please contact the manufacturer's customer service.
OV-G-V01	Grid voltage exceeds the upper voltage range	1. Confirm whether the power grid is abnormal. 2. Confirm that the AC cable is properly connected. 3. Restart the system and check if the fault persists.
UN-G-V01	Grid voltage exceeds the lower voltage range	
OV-G-F01	Grid frequency exceeds the upper frequency range	
UN-G-F01	Grid frequency exceeds the lower frequency range	
G-PHASE	Unbalanced grid voltage	
G-F-GLU	Grid voltage frequency fluctuation	
NO-Grid	No grid	1. Restart the system, confirm if that the fault continues.
OV-G-V02	Grid transient overvoltage	
OV-G-V03	Grid transient overvoltage	
IGFOL-F	Grid current tracking failure	1. Confirm whether the power grid is abnormal. 2. Confirm that the AC cable is properly connected. 3. Restart the system and check if the fault persists.
OV-G-V05	Grid voltage RMS instantaneous overvoltage fault	
OV-G-V04	Grid voltage exceeds the upper voltage range	
UN-G-V02	Grid voltage exceeds the lower voltage range	
OV-G-F02	Grid frequency exceeds the upper frequency range	1. Check on information page 1 – Verify the battery voltage is within standards. 2. Measure battery voltage at plug.
UN-G-F02	Grid frequency exceeds the lower frequency range	
NO-Battery	Battery is not connected	1. Check whether the backup port wiring is normal 2. Restart the system, confirm that the fault continues.
OV-Vbackup	Inverting overvoltage	
Over-Load	Load overload fault	1. Backup load power is too large, or some inductive load startup power is too large, need to remove some backup load, or remove the inductive load on the backup.

# 8. Troubleshooting

Message Name	Information Description	Troubleshooting Suggestion
BatName-FAIL	Wrong battery brand selection	1. Confirm whether the battery model selection is consistent with the actual one.
CAN Fail	CAN Fail	1. Can failure is a failure of communication between inverter and battery. Check cable conditions. Check to ensure you have it plugged in on the CAN port of the battery and inverter. Check that you are using the right cable. Some batteries require a special battery from the battery manufacturer.
OV-Vbatt	Battery undervoltage detected	1. Verify battery voltage is within standards. Measure battery voltage at inverter connection point. Contact your battery manufacturer for further service.
UN-Vbatt	Battery overvoltage detected	1. Restart the system and check if the fault persists. If it is still not eliminated, please contact the manufacturer's customer service.
Fan Alarm	Fan alarm	1. Check if the internal fan is working correctly or jammed.
OV-DC01 (1020 DATA:0001)	DC 1 input overvoltage	1. Check if the PV voltage is abnormal 2. Restart the system, confirm that the fault continues
OV-DC02 (1020 DATA:0002)	DC 2 input overvoltage	
OV-BUS (1021 DATA:0000)	DC bus overvoltage	1. Restart the system, confirm that the fault continues.
UN-BUS01 (1023 DATA:0001)	DC bus undervoltage	
UNB-BUS (1022 DATA:0000)	DC bus unbalanced voltage	
UN-BUS02 (1023 DATA:0002)	Abnormal detection of DC bus voltage	
DC-INTF. (1027 DATA:0000)	DC hardware overcurrent (1, 2, 3, 4)	1. Check if the DC wires are connected correctly without loose connection.
OV-G-I (1018 DATA:0000)	A phase RMS value overcurrent	1. Confirm that the grid is abnormal. 2. Confirm that the AC cable connection is not abnormal. 3. Restart the system, confirm that the fault continues.
OV-DCA-I (1025 DATA:0000)	DC 1 average overcurrent	1. Restart the system, confirm that the fault continues.
OV-DCB-I (1026 DATA:0000)	DC 2 average overcurrent	
GRID-INTF. (1030 DATA:0000)	AC hardware overcurrent (abc phase)	

# 8. Troubleshooting

Message Name	Information Description	Troubleshooting Suggestion
DCInj-FAULT (1037 DATA:0000)	The current DC component exceeds the limit	1. Confirm that the grid is abnormal. 2. Confirm that the AC cable connection is not abnormal. 3. Restart the system, confirm that the fault continues.
IGBT-OV-I (1048 DATA:0000)	IGBT overcurrent	1. Restart the system, confirm that the fault continues.
OV-TEM (1032 DATA:0000)	Module over temperature	1. Check whether the surrounding environment of the inverter has poor heat dissipation. 2. Confirm whether the product installation meets the requirements.
RelayChk-FAIL (1035 DATA:0000)	Relay failure	1. Restart the system, confirm that the fault continues.
UN-TEM (1034 DATA:0000)	Low temperature protection	1. Check the working environment temperature of the inverter. 2. Restart the system to confirm if the fault continues.
PV ISO-PRO01 (1033 DATA:0001)	PV negative ground fault	1. Check whether the PV strings have insulation problems. 2. Check whether the PV cable is damaged.
PV ISO-PRO02 (1033 DATA:0002)	PV positive ground fault	
12Power-FAULT (1038 DATA:0000)	12V undervoltage failure	1. Check current leakage to ground. Verify your grounding. Verify all wires are in good condition and not leaking current to ground.
ILeak-PRO01 (1034 DATA:0001)	Leakage current failure 01 (30mA)	
ILeak-PRO02 (1034 DATA:0002)	Leakage current failure 02 (60mA)	
ILeak-PRO03 (1034 DATA:0003)	Leakage current failure 03 (150mA)	
ILeak-PRO04 (1034 DATA:0004)	Leakage current failure 04	
ILeak_Check (1039 DATA:0000)	Leakage current sensor failure	
GRID-INTF02 (1046 DATA:0000)	Power grid disturbance 02	1. Confirm whether the grid is seriously distorted. 2. Check whether the AC cable is connected reliably.
OV-Vbatt-H/ OV-BUS-H (1051 DATA:0000)	Battery overvoltage hardware failure / VBUS	1. Check if the battery circuit breaker is tripping. 2. Check if the battery is damaged.

# 8. Troubleshooting

Message Name	Information Description	Troubleshooting Suggestion
OV-ILLC (1052 DATA:0000)	LLC hardware overcurrent	1. Check whether the backup load is overloaded. 2. Restart the system, confirm that the fault continues.
INI-FAULT (1031 DATA:0000)	AD zero drift overlink	1. Restart the system, confirm that the fault continues.
DSP-B-FAULT (1036 DATA:0000)	The master-slave DSP communication is abnormal	
AFCI-Check (1040 DATA:0000)	AFCI self-test failure	
ARC- FAULT (1041 DATA:0000)	AFCI failure	1. Verify connections are tight within your PV system. Arc fault settings can be changed in advanced settings if further adjustment is necessary.

Table 8.1 Fault message and description



**NOTE:**

If the inverter displays any alarm message as listed in Table 8.1; please turn off the inverter and wait for 5 minutes before restarting it .  
If the failure persists, please contact your local distributor or the service center.

Please keep ready with you the following information before contacting us.

1. Serial number of Solis Single Phase Inverter;
2. The distributor/dealer of Solis Single Phase Inverter (if available);
3. Installation date.
4. The description of problem (i.e. the alarm message displayed on the LCD and the status of the LED status indicator lights. Other readings obtained from the Information submenu (refer to Section 6.2) will also be helpful.);
5. The PV array configuration (e.g. number of panels, capacity of panels, number of strings, etc.);
6. Your contact details.

# 9. Specifications

Technical Data	S5-EH1P3K-L	S5-EH1P3.6K-L
<b>Input DC (PV side)</b>		
Recommended max. PV power	4800W	5700W
Max. input voltage	600V	
Rated voltage	330V	
Start-up voltage	120V	
MPPT voltage range	90-520V	
Full load MPPT voltage range	100-520V	120-520V
Max. input current	15.0A/15.0A	
Max. short circuit current	22.5A/22.5A	
MPPT number/Max input strings number	2/2	
<b>Battery</b>		
Battery Type	Li-ion / Lead-acid	
Battery Voltage range	42 - 58V	
Battery Capacity	50 - 2000Ah	
Maximum Charging Power	3kW	
Maximum Charge/discharge current	62.5A	
Communication	CAN	
<b>Output AC(Back-up)</b>		
Rated output power	3kW	
Max. apparent output power	4.5 kVA, 10SEC	
Back-up switch time	<20ms	
Rated output voltage	1/N/PE, 220 V/230 V	
Rated frequency	50Hz/60Hz	
Rated output current	14.0 A/13.5 A	
THDv(@linear load)	<3%	
<b>Input AC (Grid side)</b>		
Input voltage range	187-265V	
Max. input current	20.5 A/20.0 A	25.0 A/23.5 A
Frequency range	45-55 Hz/ 55-65Hz	

# 9. Specifications

Technical Data	S5-EH1P3K-L	S5-EH1P3.6K-L
<b>Output AC(Grid side)</b>		
Rated output power	3kW	3.6kW
Max. apparent output power	3.3kVA	4kVA
Operation phase	1/N/PE	
Rated grid voltage	220 V/230 V	
The grid voltage range	187-265 V	
Rated grid frequency	50 Hz/60 Hz	
AC grid frequency range	45-55 Hz/55-65 Hz	
Rated grid output current	13.7 A/13.1 A	16.4 A/15.7 A
Max. output current	15.0 A	18.5 A
Power Factor	>0.99 (0.8 leading - 0.8 lagging)	
THDi	<3%	
<b>Efficiency</b>		
Max efficiency	>97.1%	
EU efficiency	>96.5%	
<b>Protection</b>		
DC reverse polarity protection	Yes	
Short circuit protection	Yes	
Output over current protection	Yes	
Surge protection	DC Type II / AC Type II	
Ground fault monitoring	Yes	
Integrated AFCI (DC arc-fault circuit protection)	Yes	
Protection class / Over voltage category	I / II	

# 9. Specifications

Technical Data	S5-EH1P3K-L	S5-EH1P3.6K-L
<b>General data</b>		
Dimensions(W/H/D)	333*505*249mm	
Weight	18.3kg	
Topology	High frequency insulation (for battery)	
Operation temperature range	-25°C ~ +60°C	
Ingress protection	IP65	
Cooling concept	Natural convection	
Max.operation altitude	3000m	
Grid connection standard	G98 or G99, VDE-AR-N 4105 / VDE V 0124, EN 50549-1, VDE 0126 / UTE C 15 / VFR:2019, RD 1699 / RD 244 / UNE 206006 / UNE 206007-1, CEI 0-21, C10/11, NRS 097-2-1, TOR, EIFS 2018.2, IEC 62116, IEC 61727, IEC 60068, IEC 61683, EN 50530, MEA, PEA	
Safety/EMC standard	IEC/EN 62109-1/-2, EN 61000-6-2/-3	
<b>Features</b>		
DC connection	MC4 connector	
AC connection	Quick connection plug	
Display	7.0"LCD color screen display	
Communication	RS485, Optional:Wi-Fi, GPRS	
Warranty	5 years standard (extend to 20 years)	

# 9. Specifications

Technical Data	S5-EH1P4.6K-L	S5-EH1P5K-L*
<b>Input DC (PV side)</b>		
Recommended max. PV power	8000W	8000W
Max. input voltage	600V	
Rated voltage	330V	
Start-up voltage	120V	
MPPT voltage range	90-520V	
Full load MPPT voltage range	155-520V	170-520V
Max. input current	15.0A/15.0A	
Max. short circuit current	22.5A/22.5A	
MPPT number/Max input strings number	2/2	
<b>Battery</b>		
Battery Type	Li-ion / Lead-acid	
Battery Voltage range	42 - 58V	
Battery Capacity	50 - 2000Ah	
Maximum Charging Power	5kW	
Maximum Charge/discharge current	100A	
Communication	CAN	
<b>Output AC(Back-up)</b>		
Rated output power	5kW	
Max. apparent output power	7 kVA, 10SEC	
Back-up switch time	<20ms	
Rated output voltage	1/N/PE, 220 V/230 V	
Rated frequency	50Hz/60Hz	
Rated output current	23.0 A/22.0 A	
THDv(@linear load)	<3%	
<b>Input AC (Grid side)</b>		
Input voltage range	187-265V	
Max. input current	31.5 A/30.0 A	34.5 A/33.0 A
Frequency range	45-55 Hz/ 55-65Hz	

# 9. Specifications

Technical Data	S5-EH1P4.6K-L	S5-EH1P5K-L*
<b>Output AC(Grid side)</b>		
Rated output power	4.6kW	5kW
Max. apparent output power	4.6kVA	5.5kVA
Operation phase	1/N/PE	
Rated grid voltage	220 V/230 V	
The grid voltage range	187-265 V	
Rated grid frequency	50 Hz/60 Hz	
AC grid frequency range	45-55 Hz/55-65 Hz	
Rated grid output current	20.9 A/20.0 A	22.8 A/21.7 A
Max. output current	21.0 A	25.0 A
Power Factor	>0.99 (0.8 leading - 0.8 lagging)	
THDi	<3%	
<b>Efficiency</b>		
Max efficiency	>97.1%	
EU efficiency	>96.5%	
<b>Protection</b>		
DC reverse polarity protection	Yes	
Short circuit protection	Yes	
Output over current protection	Yes	
Surge protection	DC Type II / AC Type II	
Ground fault monitoring	Yes	
Integrated AFCI (DC arc-fault circuit protection)	Yes	
Protection class / Over voltage category	I / II	

# 9. Specifications

Technical Data	S5-EH1P4.6K-L	S5-EH1P5K-L*
<b>General data</b>		
Dimensions(W/H/D)	333*505*249mm	
Weight	18.3kg	
Topology	High frequency insulation (for battery)	
Operation temperature range	-25°C ~ +60°C	
Ingress protection	IP65	
Cooling concept	Natural convection	
Max.operation altitude	3000m	
Grid connection standard	G98 or G99, VDE-AR-N 4105 / VDE V 0124, EN 50549-1, VDE 0126 / UTE C 15 / VFR:2019, RD 1699 / RD 244 / UNE 206006 / UNE 206007-1, CEI 0-21, C10/11, NRS 097-2-1, TOR, EIFS 2018.2, IEC 62116, IEC 61727, IEC 60068, IEC 61683, EN 50530, MEA, PEA	
Safety/EMC standard	IEC/EN 62109-1/-2, EN 61000-6-2/-3	
<b>Features</b>		
DC connection	MC4 connector	
AC connection	Quick connection plug	
Display	7.0"LCD color screen display	
Communication	RS485, Optional:Wi-Fi, GPRS	
Warranty	5 years standard (extend to 20 years)	

\*S5-EH1P5K-L is not available in Germany.

# 9. Specifications

Technical Data	S5-EH1P6K-L*
<b>Input DC (PV side)</b>	
Recommended max. PV power	8000W
Max. input voltage	600V
Rated voltage	330V
Start-up voltage	120V
MPPT voltage range	90-520V
Full load MPPT voltage range	200-520V
Max. input current	15.0A/15.0A
Max. short circuit current	22.5A/22.5A
MPPT number/Max input strings number	2/2
<b>Battery</b>	
Battery Type	Li-ion / Lead-acid
Battery Voltage range	42 - 58V
Battery Capacity	50 - 2000Ah
Maximum Charging Power	5kW
Maximum Charge/discharge current	100A
Communication	CAN
<b>Output AC(Back-up)</b>	
Rated output power	5kW
Max. apparent output power	7 kVA, 10SEC
Back-up switch time	<20ms
Rated output voltage	1/N/PE, 220 V/230 V
Rated frequency	50Hz/60Hz
Rated output current	23.0 A/22.0 A
THDv(@linear load)	<3%
<b>Input AC (Grid side)</b>	
Input voltage range	187-265V
Max. input current	34.5 A/33.0 A
Frequency range	45-55 Hz/ 55-65Hz



# 9. Specifications

Technical Data	S5-EH1P6K-L*
<b>Output AC(Grid side)</b>	
Rated output power	6kW
Max. apparent output power	6.6kVA
Operation phase	1/N/PE
Rated grid voltage	220 V/230 V
The grid voltage range	187-265 V
Rated grid frequency	50 Hz/60 Hz
AC grid frequency range	45-55 Hz/55-65 Hz
Rated grid output current	27.3 A/26.1 A
Max. output current	30.0 A
Power Factor	>0.99 (0.8 leading - 0.8 lagging)
THDi	<3%
<b>Efficiency</b>	
Max efficiency	>97.1%
EU efficiency	>96.5%
<b>Protection</b>	
DC reverse polarity protection	Yes
Short circuit protection	Yes
Output over current protection	Yes
Surge protection	DC Type II / AC Type II
Ground fault monitoring	Yes
Integrated AFCI (DC arc-fault circuit protection)	Yes
Protection class / Over voltage category	I / II

# 9. Specifications

Technical Data	S5-EH1P6K-L*
<b>General data</b>	
Dimensions(W/H/D)	333*505*249mm
Weight	18.3kg
Topology	High frequency insulation (for battery)
Operation temperature range	-25°C ~ +60°C
Ingress protection	IP65
Cooling concept	Natural convection
Max.operation altitude	3000m
Grid connection standard	G98 or G99, VDE-AR-N 4105 / VDE V 0124, EN 50549-1, VDE 0126 / UTE C 15 / VFR:2019, RD 1699 / RD 244 / UNE 206006 / UNE 206007-1, CEI 0-21, C10/11, NRS 097-2-1, TOR, EIFS 2018.2, IEC 62116, IEC 61727, IEC 60068, IEC 61683, EN 50530, MEA, PEA
Safety/EMC standard	IEC/EN 62109-1/-2, EN 61000-6-2/-3
<b>Features</b>	
DC connection	MC4 connector
AC connection	Quick connection plug
Display	7.0"LCD color screen display
Communication	RS485, Optional:Wi-Fi, GPRS
Warranty	5 years standard (extend to 20 years)

\*S5-EH1P6K-L is not available in Germany.

\*According to the VDE-AR-N 4105, for models RHI-(5-6)K-48ES-5G or S5-EH1P(5-6)K-L used in Germany, the balancing device in accordance with VDE-AR-N 4100, 5.5.2 shall be used, ensures compliance with the maximum permissible unbalance  $\leq 4,6$  kVA. PAV, E monitoring as specified in 5.5.2 of VDE-AR-N 4105 application guide ensures compliance with the contractually agreed maximum permissible feed-in active power in the low-voltage network.

# 9. Specifications

Technical Data	S5-EH1P3K-L-BE	S5-EH1P3.6K-L-BE
<b>Input DC (PV side)</b>		
Recommended max. PV power	4800W	5700W
Max. input voltage	600V	
Rated voltage	330V	
Start-up voltage	120V	
MPPT voltage range	90-520V	
Full load MPPT voltage range	100-520V	120-520V
Max. input current	15.0A/15.0A	
Max. short circuit current	22.5A/22.5A	
MPPT number/Max input strings number	2/2	
<b>Battery</b>		
Battery Type	Li-ion / Lead-acid	
Battery Voltage range	42 - 58V	
Battery Capacity	50 - 2000Ah	
Maximum Charging Power	3kW	
Maximum Charge/discharge current	62.5A	
Communication	CAN	
<b>Output AC(Back-up)</b>		
Rated output power	3kW	
Max. apparent output power	4.5 kVA, 10SEC	
Back-up switch time	<20ms	
Rated output voltage	1/N/PE, 220 V/230 V	
Rated frequency	50Hz/60Hz	
Rated output current	14.0 A/13.5 A	
THDv(@linear load)	<3%	
<b>Input AC (Grid side)</b>		
Input voltage range	187-265V	
Max. input current	20.5 A/20.0 A	25.0 A/23.5 A
Frequency range	45-55 Hz/ 55-65Hz	

# 9. Specifications

Technical Data	S5-EH1P3K-L-BE	S5-EH1P3.6K-L-BE
<b>Output AC(Grid side)</b>		
Rated output power	3kW	3.6kW
Max. apparent output power	3.3kVA	4kVA
Operation phase	1/N/PE	
Rated grid voltage	220 V/230 V	
The grid voltage range	187-265 V	
Rated grid frequency	50 Hz/60 Hz	
AC grid frequency range	45-55 Hz/55-65 Hz	
Rated grid output current	13.7 A/13.1 A	16.4 A/15.7 A
Max. output current	15.0 A	18.5 A
Power Factor	>0.99 (0.8 leading - 0.8 lagging)	
THDi	<3%	
<b>Efficiency</b>		
Max efficiency	>97.1%	
EU efficiency	>96.5%	
<b>Protection</b>		
DC reverse polarity protection	Yes	
Short circuit protection	Yes	
Output over current protection	Yes	
Surge protection	DC Type II / AC Type II	
Ground fault monitoring	Yes	
Integrated AFCI (DC arc-fault circuit protection)	Yes	
Protection class / Over voltage category	I / II	

# 9. Specifications

Technical Data	S5-EH1P3K-L-BE	S5-EH1P3.6K-L-BE
<b>General data</b>		
Dimensions(W/H/D)	333*505*249mm	
Weight	18.3kg	
Topology	High frequency insulation (for battery)	
Operation temperature range	-25°C ~ +60°C	
Ingress protection	IP65	
Cooling concept	Natural convection	
Max.operation altitude	3000m	
Grid connection standard	G98 or G99, VDE-AR-N 4105/VDE V 0124, EN 50549-1, VDE 0126/UTE C 15/VFR:2019, RD 1699/RD 244/UNE 206006/ UNE 206007-1, CEI 0-21, C10/11, NRS 097-2-1, TOR, EIFS 2018.2, IEC 62116, IEC 61727, IEC 60068, IEC 61683, EN 50530, MEA, PEA	
Safety/EMC standard	IEC/EN 62109-1/-2, EN 61000-6-2/-3	
<b>Features</b>		
DC connection	MC4 connector	
AC connection	Quick connection plug	
Display	7.0"LCD color screen display	
Communication	RS485, Optional:Wi-Fi, GPRS	
Warranty	5 years standard (extend to 20 years)	

# 9. Specifications

Technical Data	S5-EH1P4.6K-L-BE	S5-EH1P5K-L-BE
<b>Input DC (PV side)</b>		
Recommended max. PV power	8000W	8000W
Max. input voltage	600V	
Rated voltage	330V	
Start-up voltage	120V	
MPPT voltage range	90-520V	
Full load MPPT voltage range	155-520V	170-520V
Max. input current	15.0A/15.0A	
Max. short circuit current	22.5A/22.5A	
MPPT number/Max input strings number	2/2	
<b>Battery</b>		
Battery Type	Li-ion / Lead-acid	
Battery Voltage range	42 - 58V	
Battery Capacity	50 - 2000Ah	
Maximum Charging Power	5kW	
Maximum Charge/discharge current	100A	
Communication	CAN	
<b>Output AC(Back-up)</b>		
Rated output power	5kW	
Max. apparent output power	7 kVA, 10SEC	
Back-up switch time	<20ms	
Rated output voltage	1/N/PE, 220 V/230 V	
Rated frequency	50Hz/60Hz	
Rated output current	23.0 A/22.0 A	
THDv(@linear load)	<3%	
<b>Input AC (Grid side)</b>		
Input voltage range	187-265V	
Max. input current	31.5 A/30.0 A	34.5 A/33.0 A
Frequency range	45-55 Hz/ 55-65Hz	

# 9. Specifications

Technical Data	S5-EH1P4.6K-L-BE	S5-EH1P5K-L-BE
<b>Output AC(Grid side)</b>		
Rated output power	4.6kW	5kW
Max. apparent output power	4.6kVA	5kVA
Operation phase	1/N/PE	
Rated grid voltage	220 V/230 V	
The grid voltage range	187-265 V	
Rated grid frequency	50 Hz/60 Hz	
AC grid frequency range	45-55 Hz/55-65 Hz	
Rated grid output current	20.9 A/20.0 A	22.8 A/21.7 A
Max. output current	21.0 A	25.0 A
Power Factor	> 0.99 (0.8 leading - 0.8 lagging)	
THDi	<3%	
<b>Efficiency</b>		
Max efficiency	>97.1%	
EU efficiency	>96.5%	
<b>Protection</b>		
DC reverse polarity protection	Yes	
Short circuit protection	Yes	
Output over current protection	Yes	
Surge protection	DC Type II / AC Type II	
Ground fault monitoring	Yes	
Integrated AFCI (DC arc-fault circuit protection)	Yes	
Protection class / Over voltage category	I / II	

# 9. Specifications

Technical Data	S5-EH1P4.6K-L-BE	S5-EH1P5K-L-BE
<b>General data</b>		
Dimensions(W/H/D)	333*505*249mm	
Weight	18.3kg	
Topology	High frequency insulation (for battery)	
Operation temperature range	-25°C ~ +60°C	
Ingress protection	IP65	
Cooling concept	Natural convection	
Max.operation altitude	3000m	
Grid connection standard	G98 or G99, VDE-AR-N 4105/VDE V 0124, EN 50549-1, VDE 0126/UTE C 15/VFR:2019, RD 1699/RD 244/UNE 206006/ UNE 206007-1, CEI 0-21, C10/11, NRS 097-2-1, TOR, EIFS 2018.2, IEC 62116, IEC 61727, IEC 60068, IEC 61683, EN 50530, MEA, PEA	
Safety/EMC standard	IEC/EN 62109-1/-2, EN 61000-6-2/-3	
<b>Features</b>		
DC connection	MC4 connector	
AC connection	Quick connection plug	
Display	7.0"LCD color screen display	
Communication	RS485, Optional:Wi-Fi, GPRS	
Warranty	5 years standard (extend to 20 years)	