



# User Manual

for S6 Series Hybrid Inverter



Applicable models  
S6-EH1P3K-L-EU/BE  
S6-EH1P3.6K-L-EU/BE  
S6-EH1P4.6K-L-EU/BE  
S6-EH1P5K-L-EU/BE  
S6-EH1P6K-L-EU

Applicable System  
Single phase system

<b>1. Introduction</b>	02
1.1 Product Description	02
1.2 Packaging	03
<b>2. Safety &amp; Warning</b>	04
2.1 Safety	04
2.2 General Safety Instructions	04
2.3 Notice For Use	06
2.4 Notice for Disposal	06
<b>3. Overview</b>	07
3.1 Intelligent LED Indicators	07
<b>4. Installation</b>	08
4.1 Select a Location for the Inverter	08
4.2 Mounting the Inverter	09
4.3 PE Cable Installation	11
4.4 PV Input Cable Installation	12
4.5 Battery Power Cable Installation	15
4.6 AC Cable Installation	16
4.7 Communication Cable Installation	18
4.8 Meter Installation	23
4.9 Inverter Remote Monitoring Connection	25
4.10 Parallel System Wiring	26
<b>5. Commissioning</b>	28
5.1 Pre-Commissioning	28
5.2 Start the Inverter	28
5.3 Stop the Inverter	28
<b>6. Operation</b>	29
6.1 Power On	29
6.2 Log in the APP via bluetooth	30
6.3 Initial Set Up	31
6.4 APP Interface	35
<b>7. Maintenance</b>	44
7.1 Smart O&M	44
<b>8. Troubleshooting</b>	45
<b>9. Specifications</b>	50

## 1.1 Product Description

The Solis S6-EH1P-L Series is designed for residential hybrid systems, which can work with batteries to optimize self-consumption. The unit can operate in both off-grid and on-grid modes.

This manual covers the Solis S6-EH1P-L Series model listed below:  
S6-EH1P3K-L-EU/BE, S6-EH1P3.6K-L-EU/BE, S6-EH1P4.6K-L-EU/BE,  
S6-EH1P5K-L-EU/BE, S6-EH1P6K-L-EU

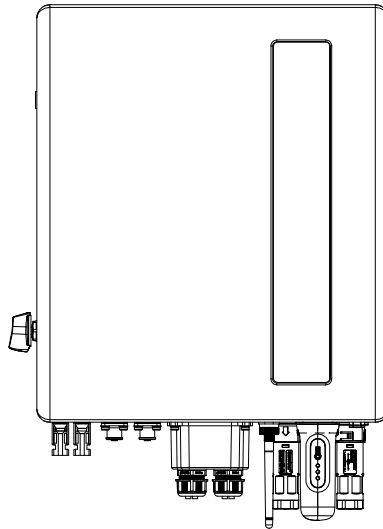

Figure 1.1 Front side view

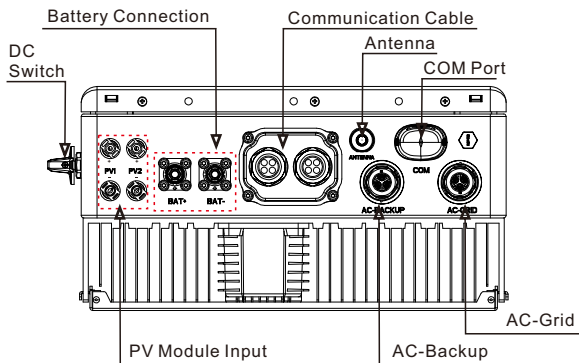
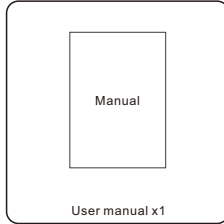
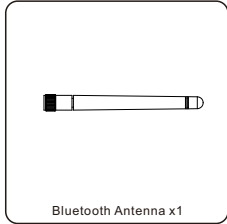
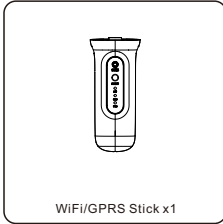
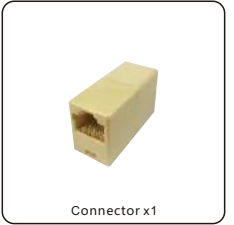
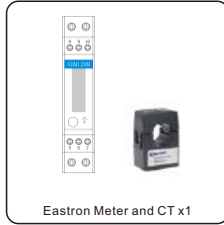
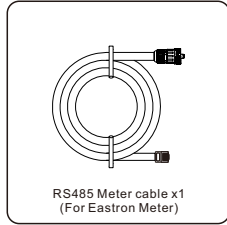
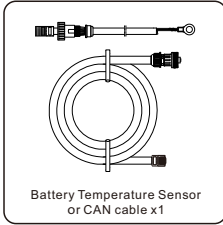
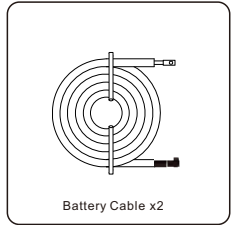
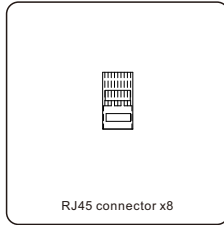
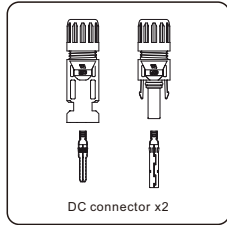
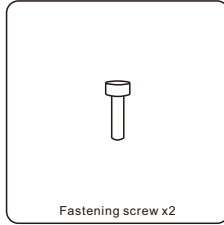
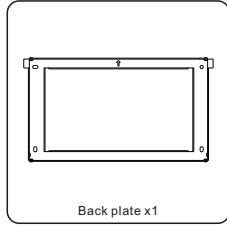
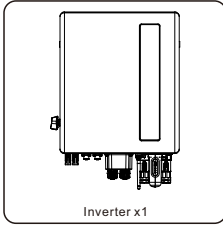

Figure 1.2 Bottom side view

## 1.2 Packaging

Please ensure that the following items are included in the packaging with your machine:



If anything is missing, please contact your local Solis distributor.

## 2.1 Safety

The following types of safety instructions and general information appear in this document as described below:



**DANGER:**

“Danger” indicates a hazardous situation which if not avoided, will result in death or serious injury.



**WARNING:**

“Warning” indicates a hazardous situation which if not avoided, could result in death or serious injury.



**CAUTION:**

“Caution” indicates a hazardous situation which if not avoided, could result in minor or moderate injury.



**NOTE:**

“Note” provides tips that are valuable for the optimal operation of your product.



**WARNING: Risk of fire**

Despite careful construction, electrical devices can cause fires.

- Do not install the inverter in areas containing highly flammable materials or gases.
- Do not install the inverter in potentially explosive atmospheres.

## 2.2 General Safety Instructions



**WARNING:**

Only devices in compliance with SELV (EN 69050) may be connected to the RS485 and USB interfaces.



**WARNING:**

Please don't connect PV array positive (+) or negative (-) to ground, it could cause serious damage to the inverter.



**WARNING:**

Electrical installations must be done in accordance with the local and national electrical safety standards.



**WARNING:**

Do not touch any inner live parts until 5 minutes after disconnection from the utility grid and the PV input.



**WARNING:**

To reduce the risk of fire, over-current protective devices (OCPD) are required for circuits connected to the inverter.

The DC OCPD shall be installed per local requirements. All photovoltaic source and output circuit conductors shall have isolators that comply with the NEC Article 690, Part II.

All Solis single phase inverters feature an integrated DC switch.



**CAUTION:**

Risk of electric shock, do not remove cover. There is no user serviceable parts inside, refer servicing to qualified and accredited service technicians.



**CAUTION:**

The PV array supplies a DC voltage when they are exposed to sunlight.



**CAUTION:**

Risk of electric shock from energy stored in capacitors of the Inverter, do not remove cover for 5 minutes after disconnecting all power sources (service technician only). Warranty may be voided if the cover is removed without authorization .



**CAUTION:**

The surface temperature of the inverter can reach up to 75 °C (167 F). To avoid risk of burns, do not touch the surface of the inverter while it's operating. Inverter must be installed out of the reach of children.



**NOTE:**

PV module used with inverter must have an IEC 61730 Class A rating.



**WARNING:**

Operations below must be accomplished by licensed technician or Solis authorized person.



**WARNING:**

Operator must put on the technicians' gloves during the whole process in case of any electrical hazards.



**WARNING:**

AC BACKUP Port of S6-EH1P-L Series is not allowed to connect to the grid.



**WARNING:**

The S6-EH1P-L Series does not support parallel in three phase operation on the AC-BACKUP port.

The inverter support parallel in single phase and support generator.  
(Only for 4.6/5/6kW)

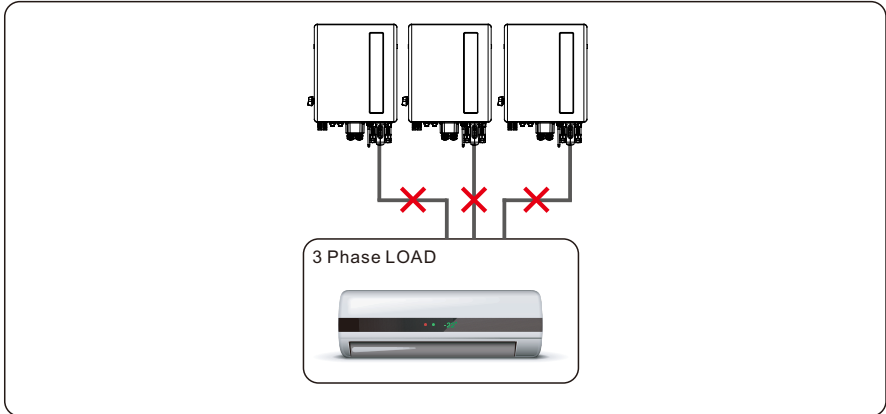

**WARNING:**

Please refer to the specification of the battery before configuration.

### 2.3 Notice For Use

The inverter has been constructed according to the applicable safety and technical guidelines. Use the inverter in installations that meet the following specifications ONLY:

1. Permanent installation is required.
2. The electrical installation must meet all the applicable regulations and standards.
3. The inverter must be installed according to the instructions stated in this manual.
4. The inverter must be installed according to the correct technical specifications.

### 2.4 Notice for Disposal

This product shall not be disposed of with household waste.

They should be segregated and brought to an appropriate collection point to enable recycling and avoid potential impacts on the environment and human health.





Local rules in waste management shall be respected .



## 3.1 Intelligent LED Indicators

There are five indicators on the The Solis S6-EH1P(3-6)K-L Series Inverter (Battery, Power, WiFi, Ethernet and Bluetooth) which indicate the working status of the inverter.

The Bluetooth Antenna or WiFi datalogger shall be installed at the Antenna/COM port of the hybrid inverter before local debugging.

Light	Status	Description
 Battery	Blue Flashing every 3s	Battery discharging.
	Blue Flashing every 1.5s	Battery charging.
	Blue Solid ON	Idle.
	OFF	No Battery or not working.
 Power	Blue Solid ON	Normally Operating.
	Yellow Solid ON	Warning.
	Red Solid ON or flashing every 3s	Alarm.
	OFF	No Battery or not working.
 WiFi	Blue Solid ON	COM Port is using.
	OFF	COM Port is not used.
 RS485	Blue Solid ON	RS485 Port is using.
	OFF	RS485 Port is not used.
 Bluetooth	Blue Solid ON	Bluetooth Port is using.
	OFF	Bluetooth Port is not used.

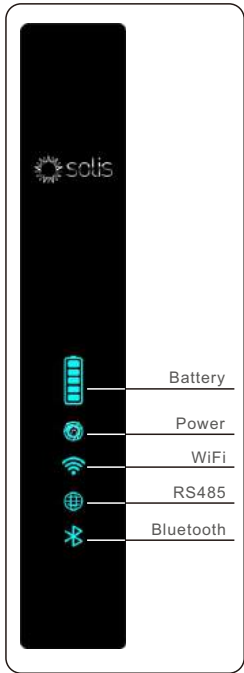

**Turning On the LED Indicator Lights**

After a few minutes, the LED indicator lights will turn off to conserve power. To turn the lights back on, short-press the Inverter LED light.



**Alarm State**

When the inverter has an alarm, the Inverter LED light turns red and starts flashing. It is recommended to connect to the inverter with the Bluetooth tool. Then you can determine what the alarm code is.



**NOTE:**

Battery/WiFi/Ethernet/Bluetooth indicators will automatically turn off after 1 minute. The Power indicator will remain on with lower brightness. Short press the Power indicator can wake up all indicators.





## 4.1 Select a Location for the Inverter

To select a location for the inverter, the following criteria should be considered:

- Exposure to direct sunlight may cause output power derating. It is recommended to avoid installing the inverter in direct sunlight.
- It is recommended that the inverter is installed in a cooler ambient which doesn't exceed 104°F/40°C.

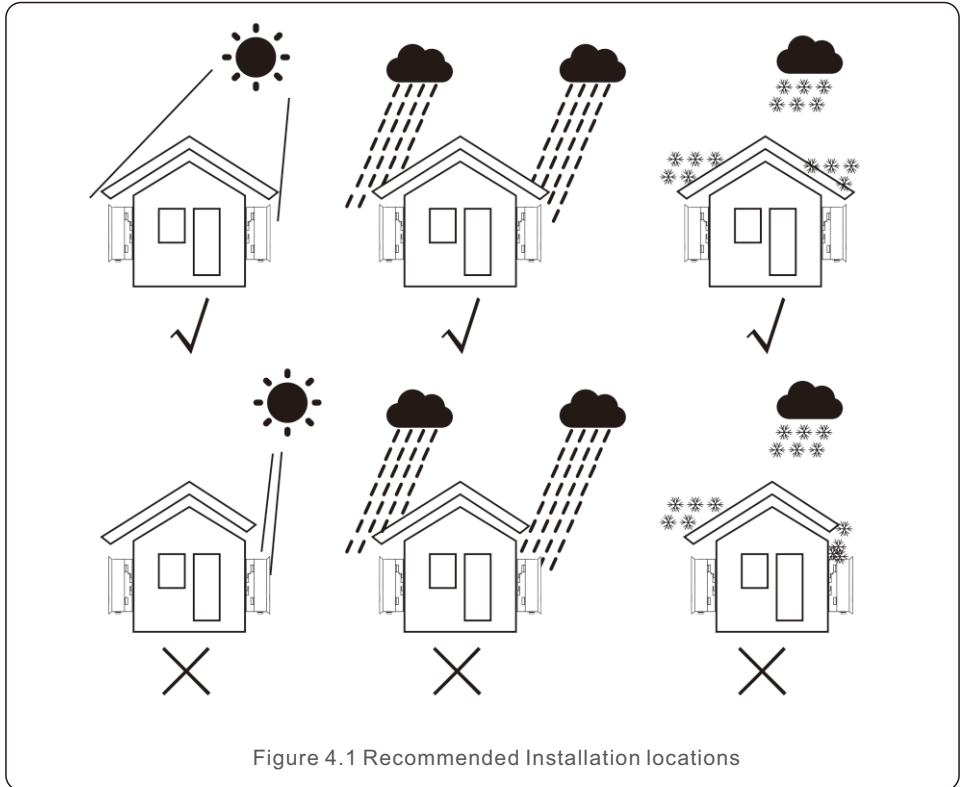

Figure 4.1 Recommended Installation locations



**WARNING: Risk of fire**

Despite careful construction, electrical devices can cause fires.

- Do not install the inverter in areas containing highly flammable materials or gases.
- Do not install the inverter in potentially explosive atmospheres.
- The mounting structure where the inverter is installed must be fireproof.

- Install on a wall or strong structure capable of bearing the weight of the machine (24.18kg).
- Install vertically with a maximum incline of +/- 5 degrees, exceeding this may cause output power derating.
- To avoid overheating, always make sure the flow of air around the inverter is not blocked. A minimum clearance of 400mm should be kept between inverters or objects and 800mm clearance between the bottom of the machine and the ground.

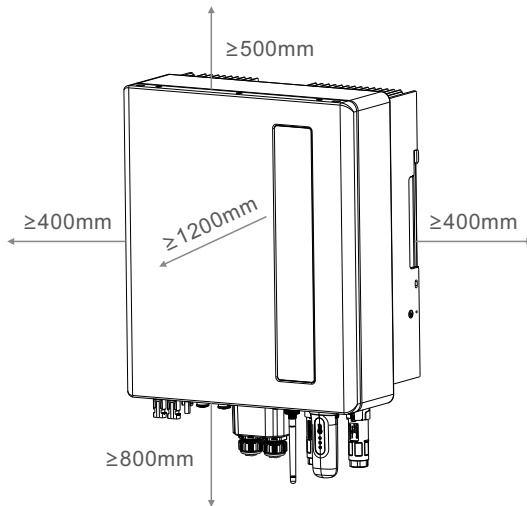

Figure 4.2 Inverter Mounting clearance

- Adequate ventilation must be provided.



**NOTE:**

Nothing should be stored on or placed against the inverter.

## 4.2 Mounting the Inverter

Dimensions of mounting bracket:

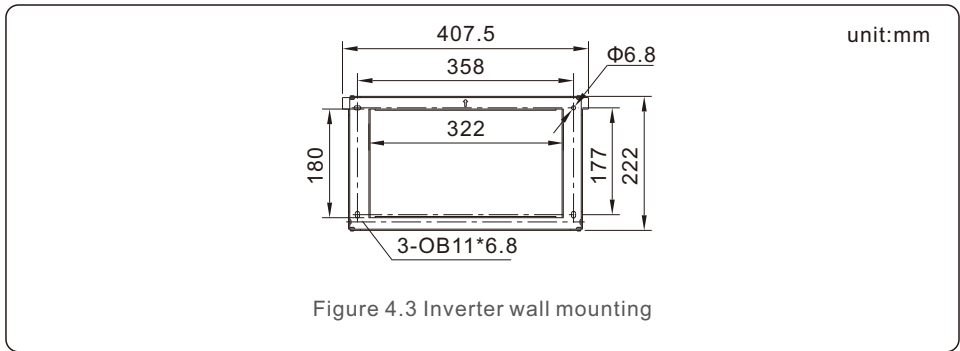

Figure 4.3 Inverter wall mounting

Once a suitable location has been found according to 4.1 using figure 4.3 mount the wall bracket to the wall.

The inverter shall be mounted vertically.

The steps to mount the inverter are listed below:

1. Select the mounting height of the bracket and mark the mounting holes.  
For brick walls, the position of the holes should be suitable for the expansion bolts.
2. Lift up the inverter (be careful to avoid body strain), and align the back bracket on the inverter with the convex section of the mounting bracket. Hang the inverter on the mounting bracket and make sure the inverter is secure (see Figure 4.4)

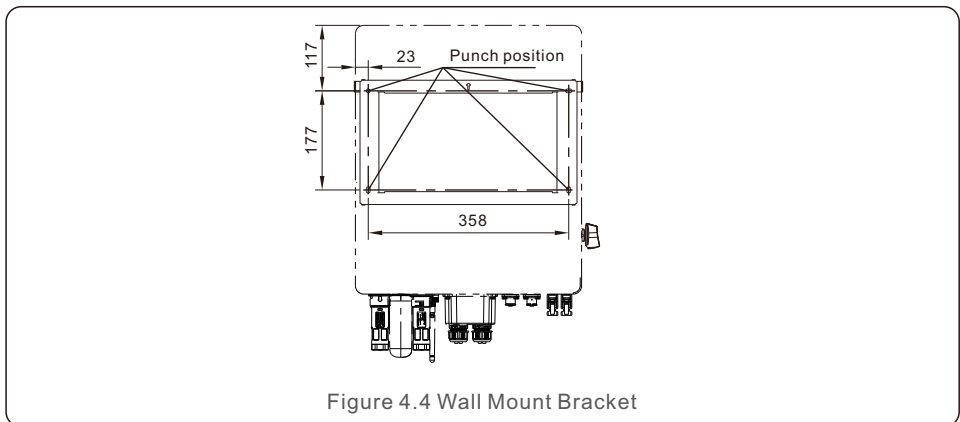
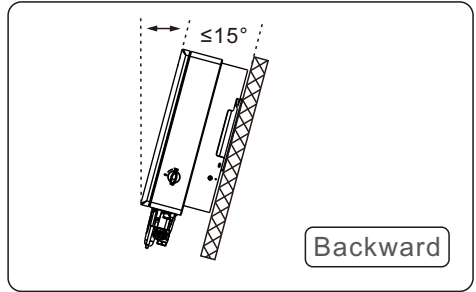
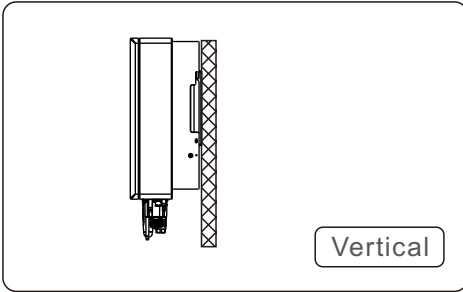

Figure 4.4 Wall Mount Bracket



**WARNING:**

The inverter must be mounted vertically.



- Install vertically ( $\pm 5^\circ$ ) or tilted backward ( $\leq 15^\circ$ ).
- Don't mount inverter on the tilted forward wall.
- Don't mount inverter on the horizontal.

## 4.3 PE Cable Installation

An external ground connection is provided at the right side of inverter.

Prepare OT terminals: M4. Use proper tooling to crimp the lug to the terminal.

Connect the OT terminal with ground cable to the right side of inverter. The torque is 2N.m.

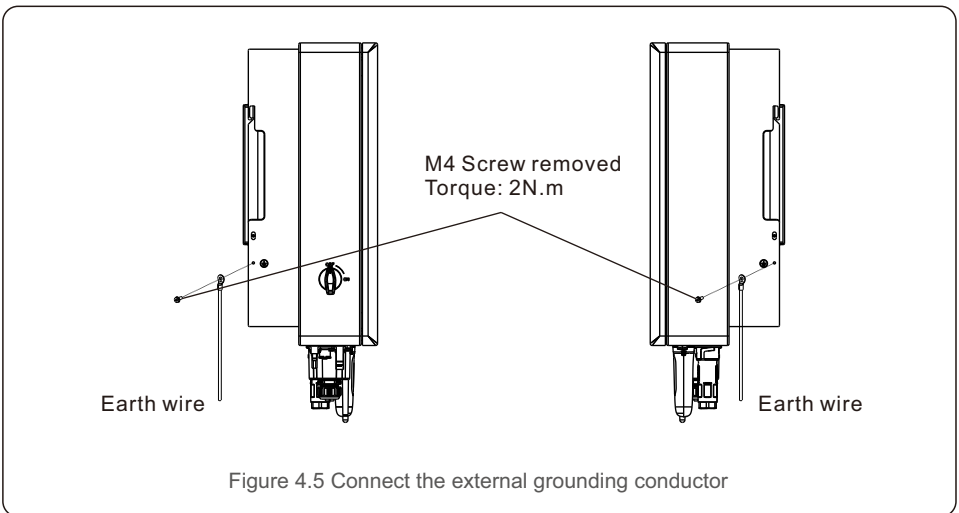

## 4.4 PV Input Cable Installation



Before connecting inverter, please make sure the PV array open circuit voltage is within the limit of the inverter.



Before connection, please make sure the polarity of the output voltage of PV array matches the "DC+" and "DC-" symbols.



Please use approved DC cable for PV system.

1. Select a suitable DC cable and strip the wires out by  $7\pm 0.5\text{mm}$ . Please refer to the table below for specific specifications.

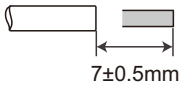

Cable type	Cross section (mm <sup>2</sup> )	
	Range	Recommended value
Industry generic PV cable	4.0~6.0 (12~10AWG)	4.0 (12AWG)

Figure 4.6

2. Take the DC terminal out of the accessory bag, turn the screw cap to disassemble it, and take out the waterproof rubber ring.

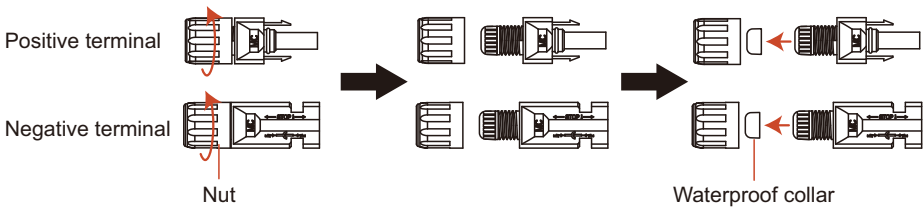
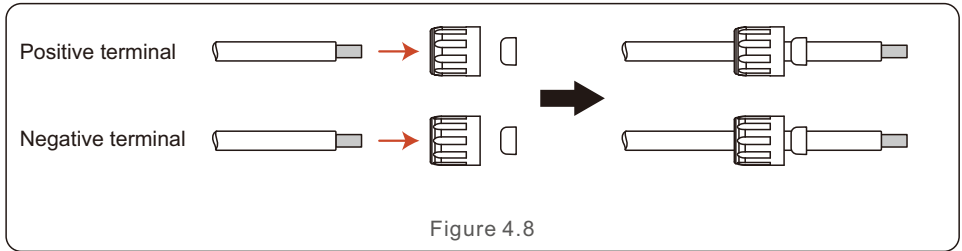
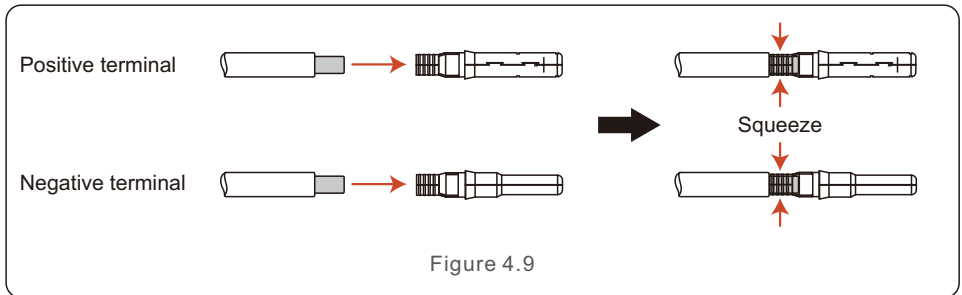

Figure 4.7

3. Pass the stripped DC cable through the nut and waterproof rubber ring.



4. Connect the wire part of the DC cable to the metal DC terminal and crimp it with a special DC terminal crimping tool.



5. Insert the crimped DC cable into the DC terminal firmly, then insert the waterproof rubber ring into the DC terminal and tighten the nut.

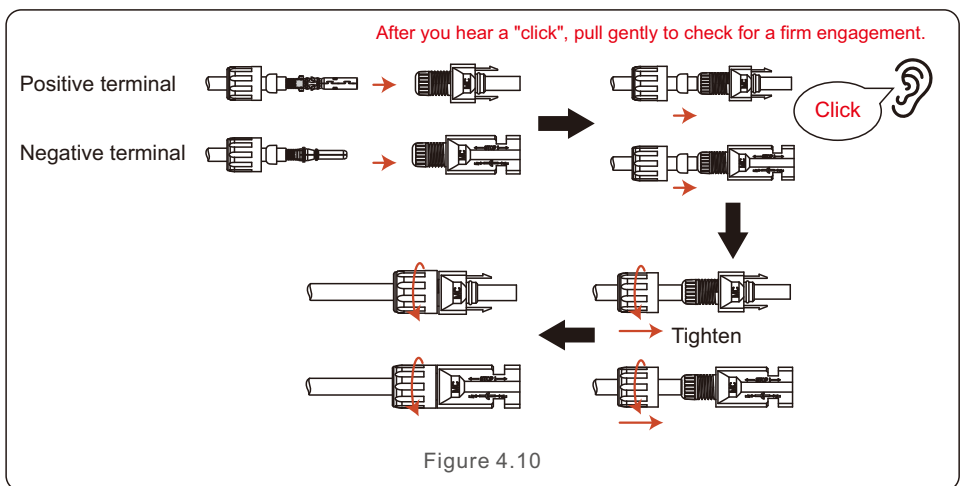

6. Measure PV voltage of DC input with multimeter, verify DC input cable polarity.

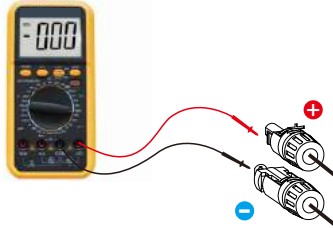

Figure 4.11

7. Connect the wired DC terminal to the inverter as shown in the figure, and a slight "click" is heard to prove the connection is correct.

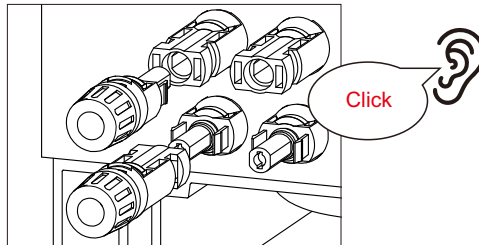

Figure 4.12



**CAUTION:**

If DC inputs are accidentally reversely connected or inverter is faulty or not working properly, it is NOT allowed to turn off the DC switch. Otherwise it may cause DC arc and damage the inverter or even lead to a fire disaster. The correct actions are:

\*Use a clip-on ammeter to measure the DC string current.

\*If it is above 0.5A, please wait for the solar irradiance reduces until the current decreases to below 0.5A.

\*Only after the current is below 0.5A, you are allowed to turn off the DC switches and disconnect the PV strings.

\* In order to completely eliminate the possibility of failure, please disconnect the PV strings after turning off the DC switch to avoid secondary failures due to continuous PV energy on the next day.

Please note that any damages due to wrong operations are not covered in the device warranty.

## 4.5 Battery Power Cable Installation



**NOTE:**

1. The positive wiring (the angle of the limit tip is 90°) is connected to the positive socket, and the negative wiring (the angle of the limit tip is 180°) is connected to the negative socket;
2. When the terminal is inserted into the corresponding socket, you need to press the circular button on the terminal lightly and pay attention to the direction of the limit pin and the socket slot.

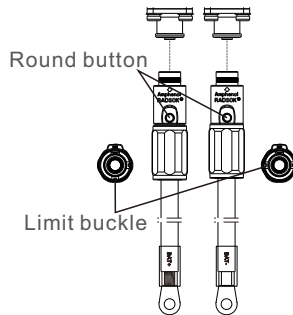
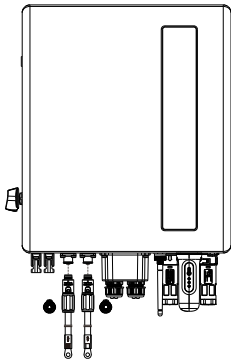

Figure 4.13



## 4.6 AC Cable Installation

There are two AC terminals and the assembly steps for both are the same.  
Take out the AC connector parts from the packaging.

Describe	Numerical value
Cable diameter	10~14mm
Traverse cross sectional area	6~8mm <sup>2</sup>
Exposure Length	9mm

Table 4.1

1. Disassemble the AC connector. Strip the AC wires about 9mm.

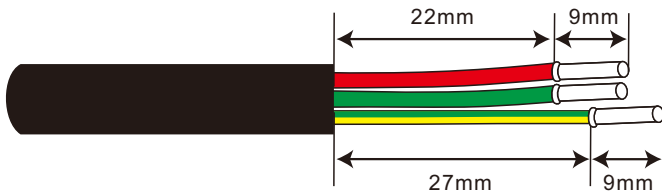

Figure 4.14

2. Set the parts on the cable.

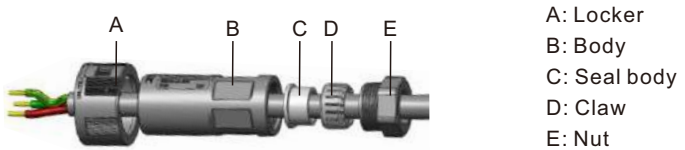

Figure 4.15

3. Crimp wires screw twisting torque 0.8+/-0.1N·m.

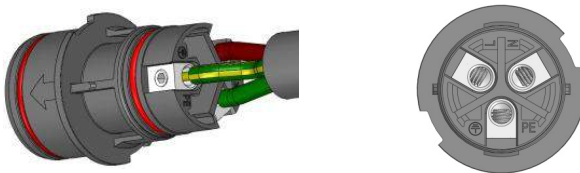

Figure 4.16

4. Push Housing into Body.

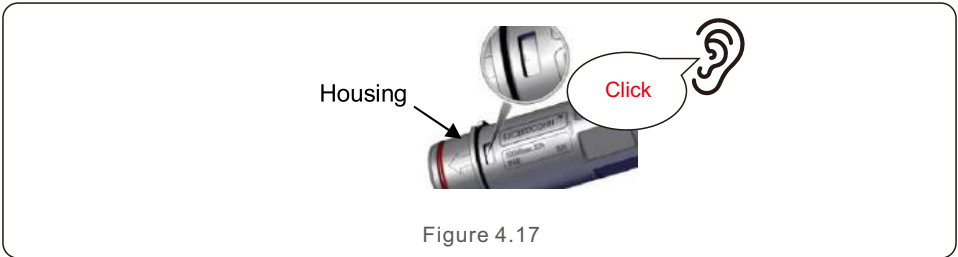

Figure 4.17

5. Insert Seal and Clamp Finger into socket ,then tighten the nut , torque 4+/-0.5N·m.

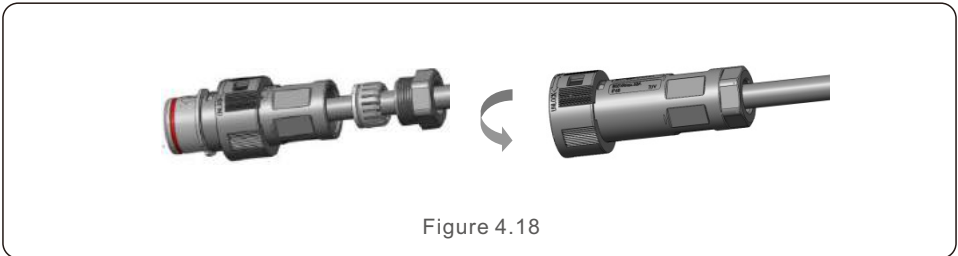

Figure 4.18

6. The same installation for both cable end plug and socket connectors.

7. Mating plug and socket: Push the plug into the socket completely, then rotate the locker according to the direction instructed by the marks on the locker.

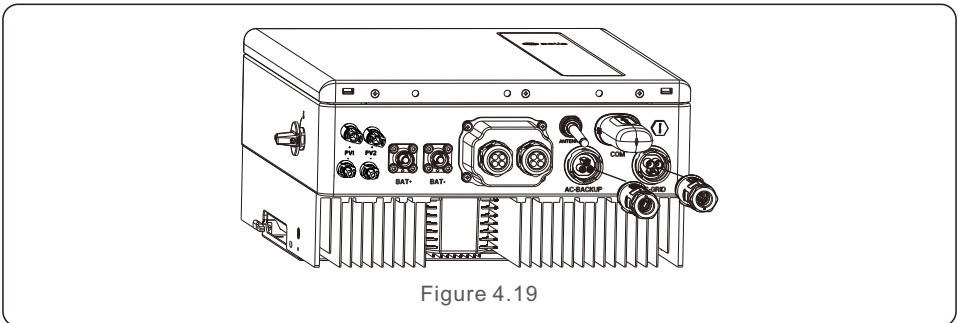

Figure 4.19



**NOTE:**

Before mating the plug and socket, please double check both AC Grid and AC Backup connectors. Do not connect the grid cables to the AC Backup port or connect the backup load cables to the AC Grid Port. Otherwise, it may leads to malfunction or damage.

## 4.7 Communication Cable Installation

### 4.7.1 Protective Cover for Communication Ports

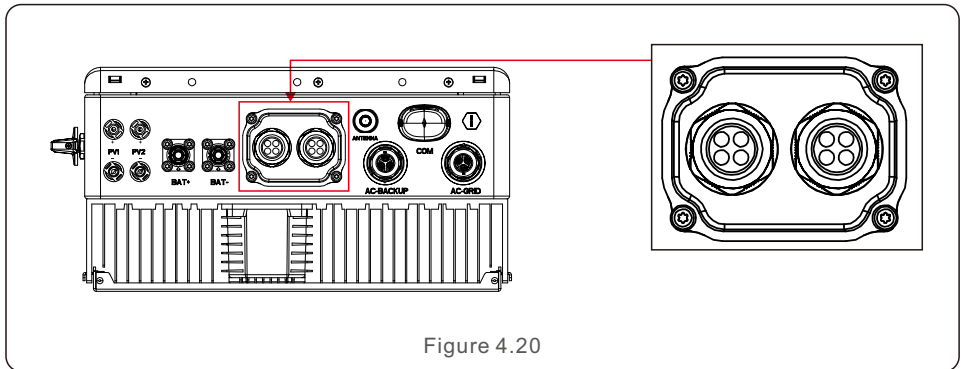

Figure 4.20

Inverter in the package is with a protective cover assembled to protect the communication ports.

Step 1. Use Phillips screwdriver to take out the 4 screws on the cover.

Step 2. Read through the following sections of the manual and prepare the internet cables correspondingly.

Step 3. Loose the cable gland and remove the watertight caps inside the cable gland based on the number of the cables and keep the unused holes with watertight cap.

Step 4. Lead the cables into the holes in the cable gland. (Hole Diameter: 6mm)

Step 5. Crimp the RJ45 connectors onto the cables according to the pin definitions described in the following sections and connect to the ports accordingly.

Step 6. Fasten the 4 screws on the cover (Torque: 1.7N.m-2 N.m)

Step 7. Reassemble the cable gland and ensure there is no bending or stretching of the internet cables inside the cover.



**NOTE:**

The 4-hole fastening rings inside the cable gland are with openings on the side. Please separate the gap with hand and squeeze the cables into the holes from the side openings.

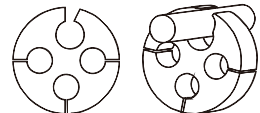

## 4.7.2 Communication Port Definition

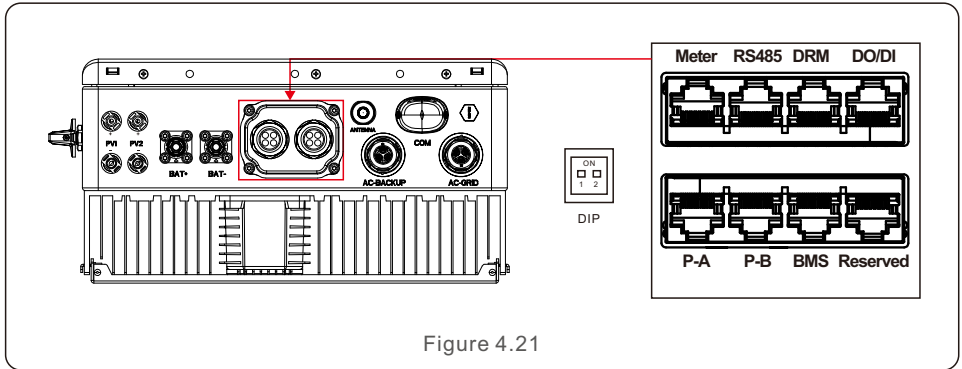

Figure 4.21

Port	Function
BMS	Used for CAN communication between inverter and Lithium battery BMS.
Meter	Used for RS485 communication between inverter and the smart meter. It is necessary to realize the normal hybrid control logics.
DRM	(Optional) To realize Demand Response or Logic interface function, this function may be required in UK and Australia.
RS485	(Optional) Used for Modbus RTU communication with 3rd party external device or controller.
P-A/P-B	(Optional) Parallel operation communication ports (Reserved).
DO/DI	(Optional) Dry contact port (Reserved).
DIP Switch	When a single inverter is running, DIP switch 1 and 2 shall be both at the bottom position. When multiple inverters are paralleled, DIP switch: Option 1: Both the first and last inverter (INV1 & INV3) have 1 of the DIP switch enabled (Either Pin1 or Pin2). Option 2: One of the first and the last inverter (INV1 or INV3) has 2 DIP switches enabled (Both Pin1 & Pin2)

Table 4.3

## 4.7.3 BMS Port Connection

Take out the pre-made CAN cable from the package and connect one end to battery CAN port and then connect another end to the inverter BMS port. Cable Length: 3 meters.



Figure 4.22



**NOTE:**

Before connecting CAN cable with the battery, please check whether the communication pin sequence of the inverter and the battery match; If it does not match, you need to cut off the RJ45 connector at one end of the CAN cable and adjust the pin sequence according to the pin definitions of both inverter and battery.

Pin definition of the inverter CAN Port is following EIA/TIA 568B.

CAN-H on Pin 4: Blue

CAN-L on Pin 5: Blue/White

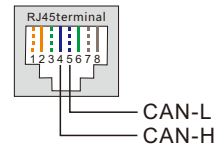

## 4.7.4 Meter Port Connection

Take out the pre-made Meter cable from the package and connect RJ45 end to inverter Meter port and then connect another end with loose RS485 A & B pins to the meter RS485 terminal. Cable Length: 5 meters.



Figure 4.23



**NOTE:**

Pin definition of the Meter Port is following EIA/TIA 568B.

RS485A on Pin 1: Orange/white

RS485B on Pin 2: Orange

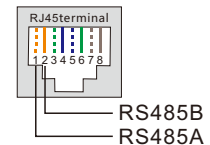

**NOTE:**

Compatible Smart Meter Pin definition.

Eastron SDM630MCT – Pin 13 is RS485B & Pin 14 is RS485A.

Eastron SDM630 – Pin B is RS485B & Pin A is RS485A.

## 4.7.5 DRM Port Connection (Optional)

### 4.7.5.1 For Remote Shutdown Function

Solis inverters support remote shutdown function to remotely control the inverter to power on and off through logic signals.

The DRM port is provided with an RJ45 terminal and its Pin5 and Pin6 can be used for remote shutdown function.

Signal	Function
Short Pin5 and Pin6	Inverter Generates
Open Pin5 and Pin6	Inverter Shutdown in 5s

Table 4.2

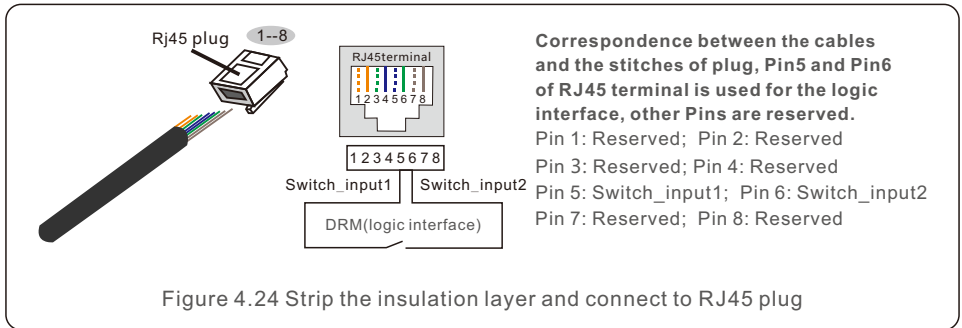

Figure 4.24 Strip the insulation layer and connect to RJ45 plug

### 4.7.5.2 For DRED Control Function (For AU and NZ Only)

DRED means demand response enable device. The AS/NZS 4777.2:2020 required inverter need to support demand response mode(DRM).

This function is for inverter that comply with AS/NZS 4777.2:2020 standard.

A RJ45 terminal is used for DRM connection.

Pin	Assignment for inverters capable of both charging and discharging	Pin	Assignment for inverters capable of both charging and discharging
1	DRM 1/5	5	RefGen
2	DRM 2/6	6	Com/DRM0
3	DRM 3/7	7	V+
4	DRM 4/8	8	V-

Table 4.5



**NOTE:**

Solis hybrid inverter is designed to provide 12V power for DRED.

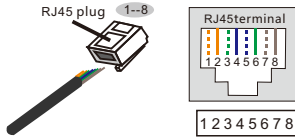

**Correspondence between the cables and the stitches of plug**

- Pin 1: white and orange ; Pin 2: orange
- Pin 3: white and green; Pin 4: blue
- Pin 5: white and blue; Pin 6: green
- Pin 7: white and brown; Pin 8: brown

Figure 4.25 Strip the insulation layer and connect to RJ45 plug

### 4.7.6 RS485 Port Connection (Optional)

If a 3rd party external device or controller needs to communicate with the inverter, the RS485 port can be used. Modbus RTU protocol is supported by Solis inverters. To acquire latest protocol document, please contact Solis local service team or Solis sales.



**NOTE:**

Pin definition of the RS485 Port is following EIA/TIA 568B.

- RS485A on Pin 5: Blue/White
- RS485B on Pin 4: Blue

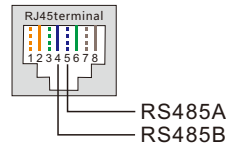

## 4.8 Meter Installation



**CAUTION:**

Make sure the AC cable is totally isolated from AC power before connecting the Smart Meter and CT.

A Smart Meter with the CT in product box is compulsory for hybrid system installation. It can be used to detect the grid voltages and current directions, provide the operating condition of the hybrid inverter via RS485 communications.



**NOTE:**

1. The Smart Meter with CT is already configured ; please do not change any settings on the Smart Meter.
2. One Smart Meter can be used with only one hybrid inverter.

The Solis S6-EH1P-L Series inverter is able to connected Acrel meters or Eastron meters to fulfill the control logic of the self-consumption mode, export power control, monitoring, etc.

Easton 1ph meter (With CT): SDM120CTM

Meter RS485 Pin Definition: Pin 9 – RS485B, Pin 10 – RS485A

Below 4.8.1 section describes the connection diagram of 1ph meter Eastron SDM120CTM.



**NOTE:**

Please note that the CT orientation must be correct, otherwise the system will not work properly.





## 4.8.1 Single phase meter installation

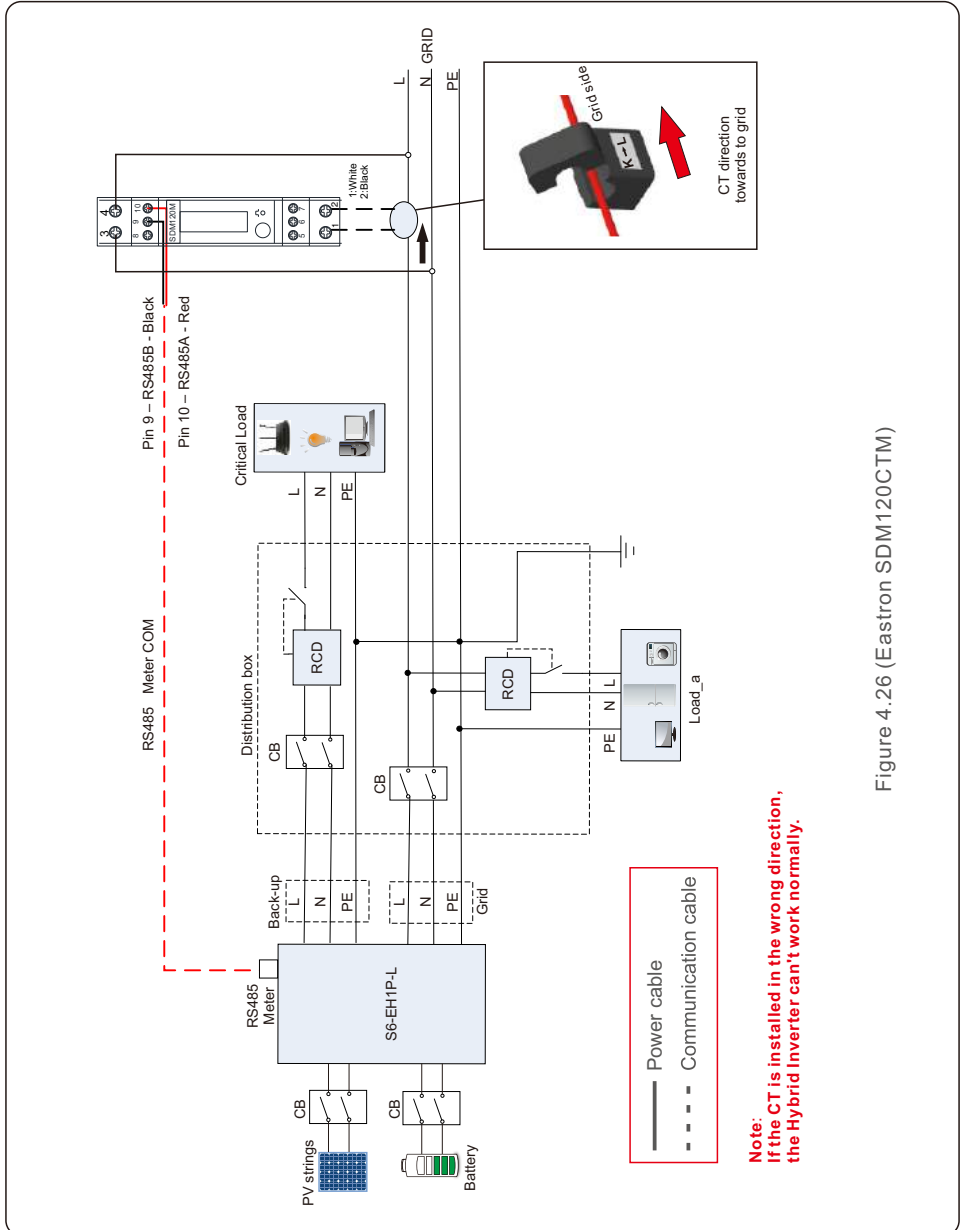

Figure 4.26 (Eastron SDM120CTM)

## 4.9 Inverter Remote Monitoring Connection

The inverter can be remotely monitored via WiFi, LAN or 4G.

The USB type COM port at the bottom of the inverter can connect to different kinds of Solis data loggers to realize the remote monitoring on Soliscloud platform.

To install Solis data loggers, please refer to corresponding user manuals of Solis data loggers.

The Solis data loggers are optional and can be purchased separately.

Dust cover is provided the inverter package in case the port is not used.



**WARNING:**

The USB type COM port is only allowed to connect Solis data loggers. It is forbidden to be used for other purposes.

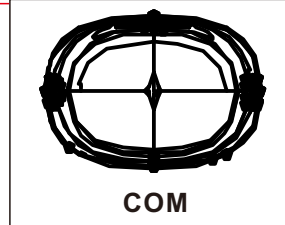
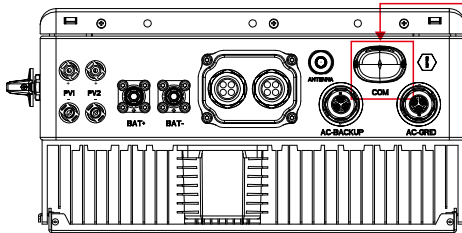

Figure 4.27

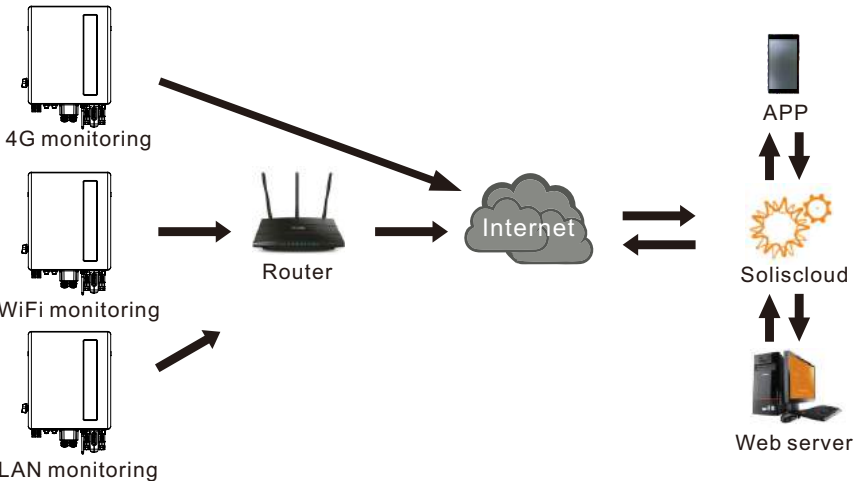

Figure 4.28 Wireless communication function

## 4.10 Parallel System Wiring



**NOTE:**

Only 4.6/5/6kW can be parallel, 3/3.6kW cannot.

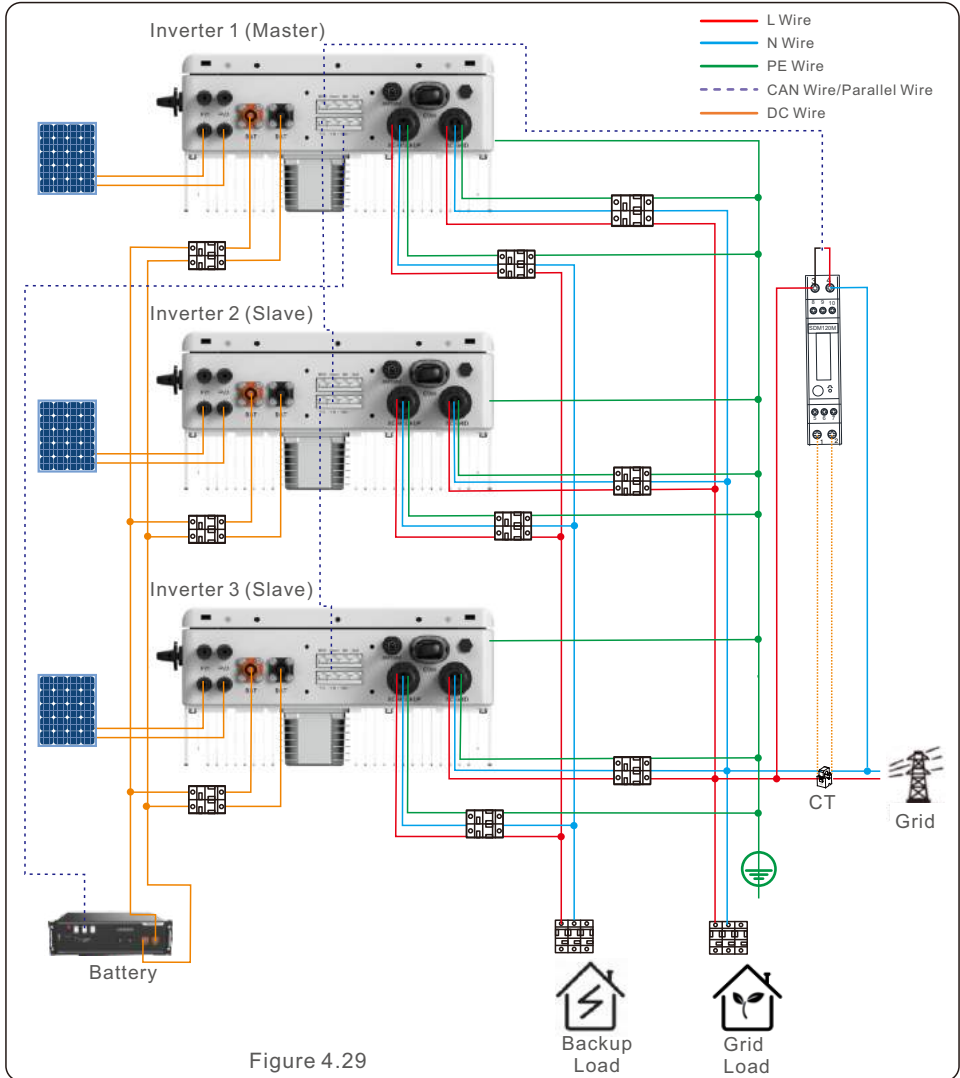

When multiple inverters are connecting in parallel, ONLY same model (same power rating) can be used.



**NOTE:**

Only 4.6/5/6kW can be parallel, 3/3.6kW cannot.

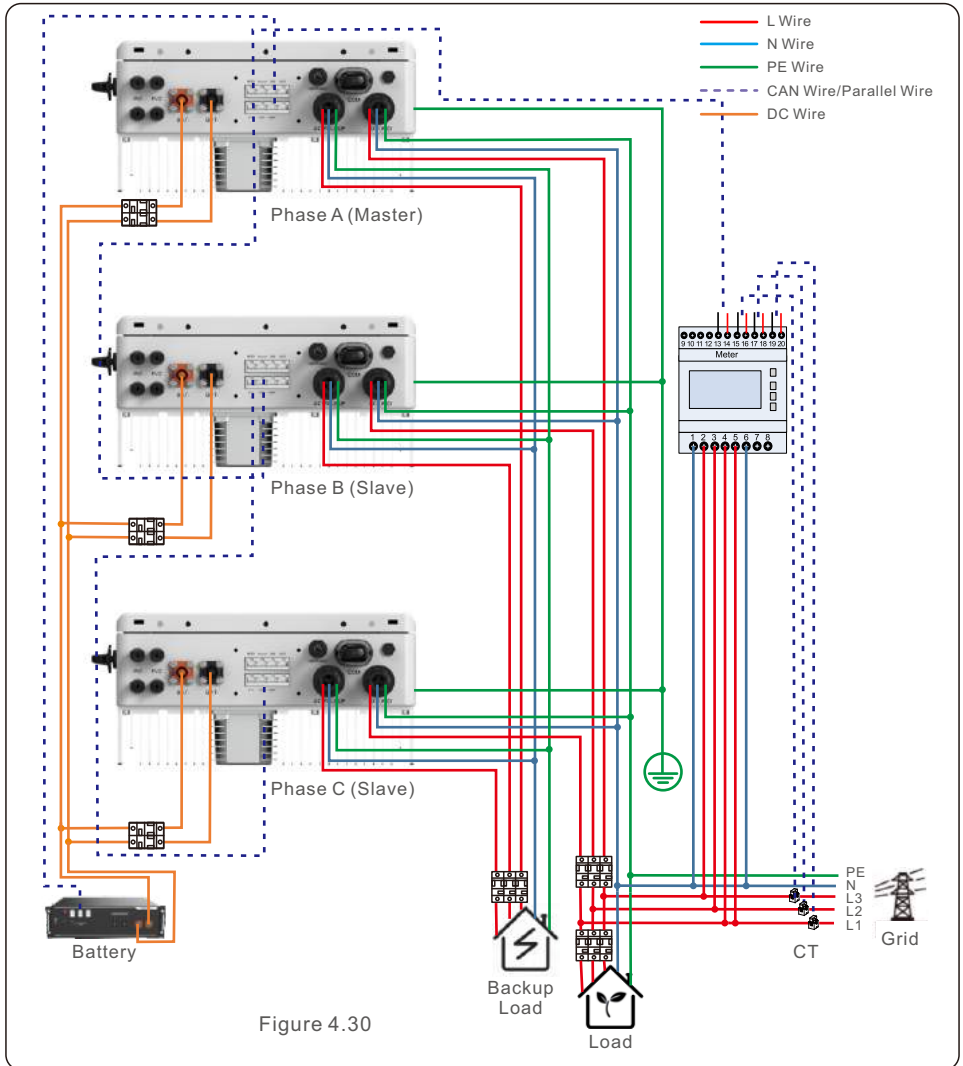

When multiple inverters are connecting in parallel, ONLY same model (same power rating) can be used.

## 5.1 Pre-Commissioning

- Make sure that no high voltage conductors are energized.
- Check all conduit and cable connection points ensure they are tight.
- Verify that all system components have adequate space for ventilation.
- Follow each cable to ensure that they are all terminated in the proper places.
- Ensure that all warning signs and labels are affixed on the system equipment.
- Verify that the inverter is secured to the wall and is not loose or wobbly.
- Prepare a multimeter that can do both AC and DC amps.
- Have an Android or Apple mobile phone with Bluetooth capability.
- Install the Soliscloud APP on the mobile phone and register a new account.
- There are three ways to download and install the latest APP.

1.You can visit [www.soliscloud.com](http://www.soliscloud.com).

2.You can search"Soliscloud" in Google Play or APP Store.

3.You can scan this QR code to download Soliscloud.



## 5.2 Start the Inverter

Step 1: With the DC switch off, energize the PV strings and then measure DC voltage of the PV strings to verify that the voltage and polarity are correct. Turn on the battery and check the battery voltage and polarity as well.

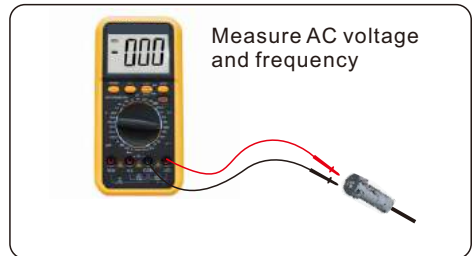
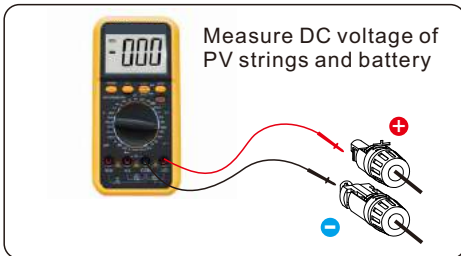

Step 2: Turn on the OCPD for the system and then measure the AC voltages line to line and line to neutral. The backup side of the system will be off until commissioning is complete. Turn the OCPD back off for now.

Step 3: Turn the DC switch on and then the OCPD(AC breaker) for the system.

This inverter can be powered on by PV only, battery only and Grid only.

When the inverter is powered on,the five indicators will be lighted at once.

## 5.3 Stop the Inverter

Step 1. Turn off the AC circuit breaker at the grid-connection point.

Step 2. Turn off the DC switch of the inverter.

Step 3. Turn off the battery circuit breaker.

Step 4. Wait until the device is powered off and the system is shut down.

## 6.1 Power On

This inverter can be powered on by PV only, battery only and Grid only. It is suggested that turn on the battery firstly, then set the parameters. After setting, turn on PV and GRID breakers to check whether the system runs properly.

When the inverter is powered on, the five indicators will be lighted at once.

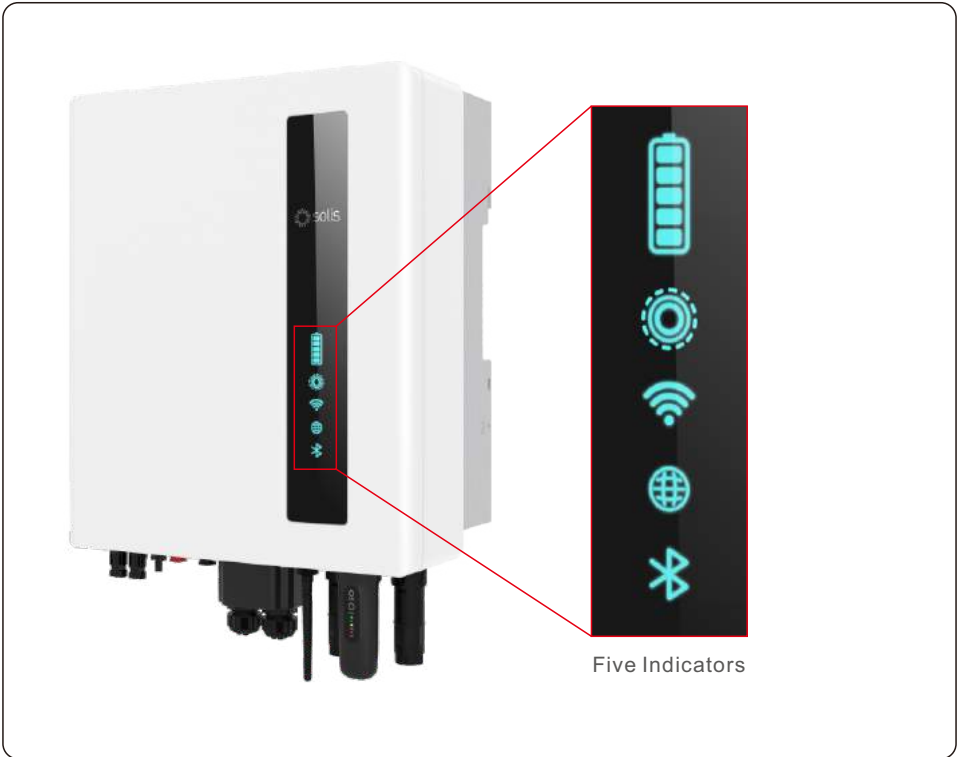

## 6.2 Log in the APP via Bluetooth

### Step 1: Connect with Bluetooth.

Turn on Bluetooth switch on your mobile phone and then open the Soliscloud APP. Click "More Tools"->"Local Operation"->"Connect with Bluetooth"

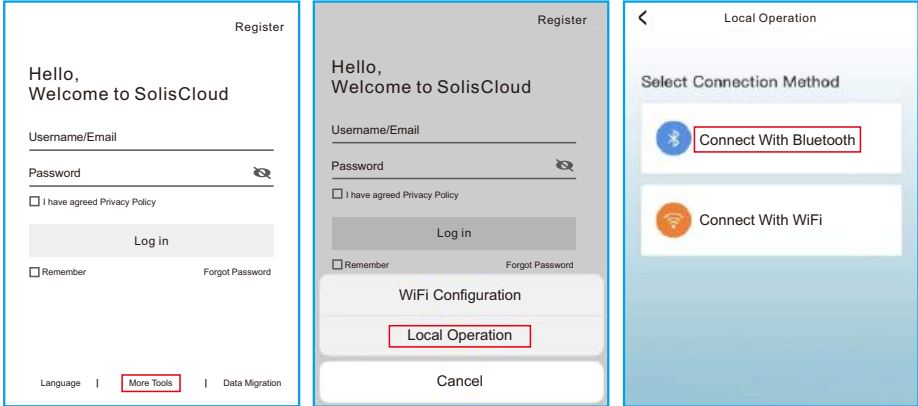

### Step 2: Select the Bluetooth signal from the inverter. (Bluetooth Name: Inverter SN)

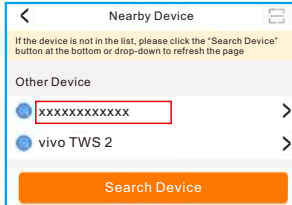

### Step 3: Login account.

If you are the installer, please select the account type as Installer. If you are the plant owner, please select the account type as owner. Then set your own initial password for control verification. (The first log-in must be finished by installer in order to do the initial set up)

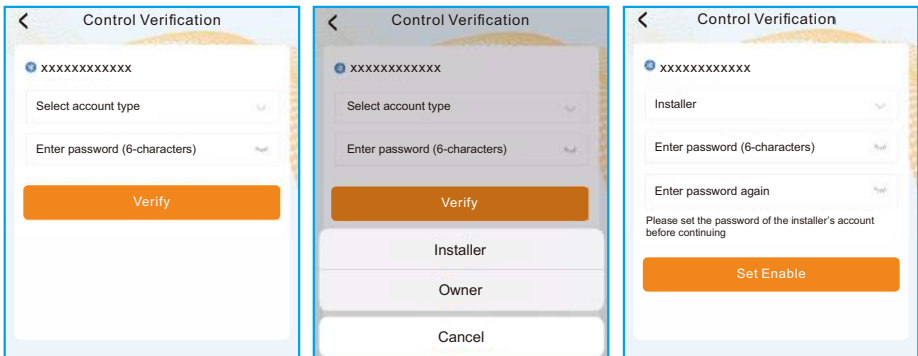

## 6.3 Initial set up

If this is the first time the inverter has been commissioned, you will need to first go through the Quick Settings. Once this has been done, these settings can be changed later.

### **Inverter Time -> Battery Model -> Meter Setting -> Grid Code -> Work mode**

A. Inverter Time: Set the Inverter Time and Date. It may be easier to tap the slider next to "Follow Phone Time". Then tap Next in the top right corner. This will set the inverter to match your phone.

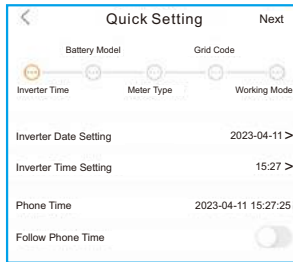

B. Battery Model: Now select the battery model connected to the inverter. This choice must be based on the battery model that is actually connected to the inverter. If there is no battery connected for the moment, select "No Battery" to avoid potential alarms codes.

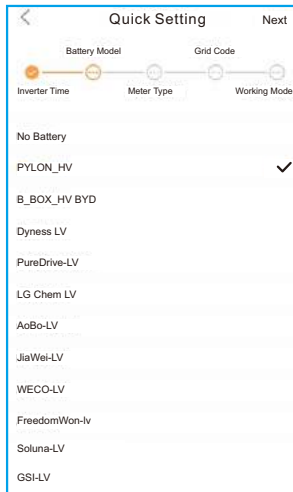



C. Meter Setting: Set both the Meter Type and the Meter Location. It is suggested to install the meter at the system grid connection point and select “Meter in Grid”. If there is no meter connected for the moment, please select “No Meter” to avoid alarms.

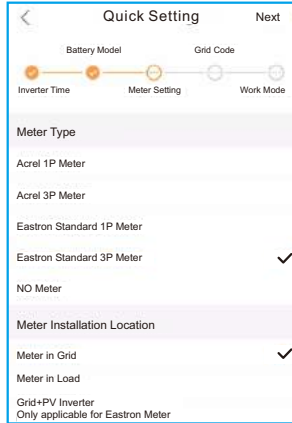

D. Grid Code: Please select the grid code based on the local grid network requirements.

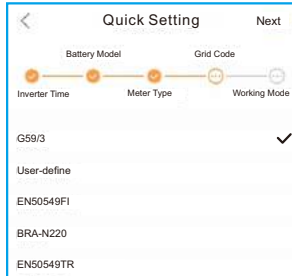

E. Work Mode: This is the energy storage operating mode. ALL modes first priority is to use the available PV power to support the home loads. The different modes determine what the second priority, or use of the excess PV power, will be. Select the desired mode, then tap the slider switch to turn the mode on. The switch will appear orange if it is enabled.

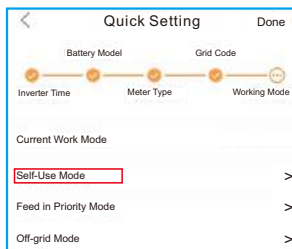

**Self-Use Mode** stores the excess PV power into the battery. If the battery is charged, or there is no battery, the excess PV power will be exported (sold) back to the utility company. If the system is set to not export any power, then the inverter will curtail the PV power (derate the inverter output power).

**Feed in Priority Mode** will ensure that the system exports any excess PV power after the home loads are supplied. If the export power quota has been met, then the remaining PV power will be stored in the battery. This mode should not be used if export power is going to be set to zero.

**Off-Grid Mode** is only to be used by systems that are not electrically connected to the grid at all. This mode is like Self-Use Mode, but the PV power will be curtailed if the battery is charged and the home load demand is lower than the amount of available PV power.

**Backup Mode** can be opened in the Self-Use or Feed in Priority Mode. What this mode does is ensure that the battery does not drain past the Reserve SOC (state-of-charge) percentage. The battery will cycle between 100% and the Reserve SOC, so if grid power is lost, the battery will have the Reserve SOC at the very least to carry the home through the outage.

**Time of Use Switch** is for customizing when the battery is allowed to charge and discharge power and at what rate, established by a current (amperage) setting. If this slider switch is turned on, the inverter will only use this schedule to determine when to charge and discharge the battery. If Allow Grid Charging is turned on, the inverter will use grid power to charge the battery only under two circumstances: (1) the battery drains to the Force Charge SOC. (2) Time of Use is enabled and there is not enough available PV power during the charge window to meet the current rate that is established.

**Time of Use is for manual control of the battery charging/discharging. If Time of Use is turned off, charging/discharging is automatically regulated by the inverter.**

Self-Use Mode	Feed in Priority Mode	Off-Grid Mode
Self-Use Mode Switch <input type="checkbox"/>	Feed in Priority Mode Switch <input checked="" type="checkbox"/>	Off-grid Mode Switch <input checked="" type="checkbox"/>
Time of Use Switch <input type="checkbox"/>	Time of Use Switch <input checked="" type="checkbox"/>	Off-grid Overdischarge SOC 30% >
Time of Use Charge Current Set 50.0A >	Time of Use Charge Current Set 135.0A >	
Time of Use Discharge Current Set 50.0A >	Time of Use Discharge Current Set 135.0A >	
Charge Time Slot 1 22:00 ~ 08:00 >	Charge Time Slot 1 00:00 ~ 01:00 >	
Discharge Time Slot 1 08:00 ~ 22:00 >	Discharge Time Slot 1 01:00 ~ 02:00 >	
Charge Time Slot 2 00:00 ~ 00:00 >	Charge Time Slot 2 02:00 ~ 04:00 >	
Discharge Time Slot 2 00:00 ~ 00:00 >	Discharge Time Slot 2 04:00 ~ 06:00 >	
Charge Time Slot 3 00:00 ~ 00:00 >	Charge Time Slot 3 06:00 ~ 10:00 >	
Discharge Time Slot 3 00:00 ~ 00:00 >	Discharge Time Slot 3 10:00 ~ 11:00 >	
Charge Time Slot 4 00:00 ~ 00:00 >	Charge Time Slot 4 11:00 ~ 14:00 >	
Discharge Time Slot 4 00:00 ~ 00:00 >	Discharge Time Slot 4 14:00 ~ 17:00 >	
Charge Time Slot 5 00:00 ~ 00:00 >	Charge Time Slot 5 17:30 ~ 18:00 >	
Discharge Time Slot 5 00:00 ~ 00:00 >	Discharge Time Slot 5 18:00 ~ 22:55 >	
Charge Time Slot 6 00:00 ~ 00:00 >	Charge Time Slot 6 23:00 ~ 23:30 >	
Discharge Time Slot 6 00:00 ~ 00:00 >	Discharge Time Slot 6 23:30 ~ 00:00 >	
Allow Grid Charging <input checked="" type="checkbox"/>	Allow Grid Charging <input checked="" type="checkbox"/>	
Backup Mode Switch <input type="checkbox"/>	Backup Mode Switch <input type="checkbox"/>	
Reserved SOC 80% >	Reserved SOC 80% >	

## 6.4 APP Interface

### 6.4.1 APP Interface Structure

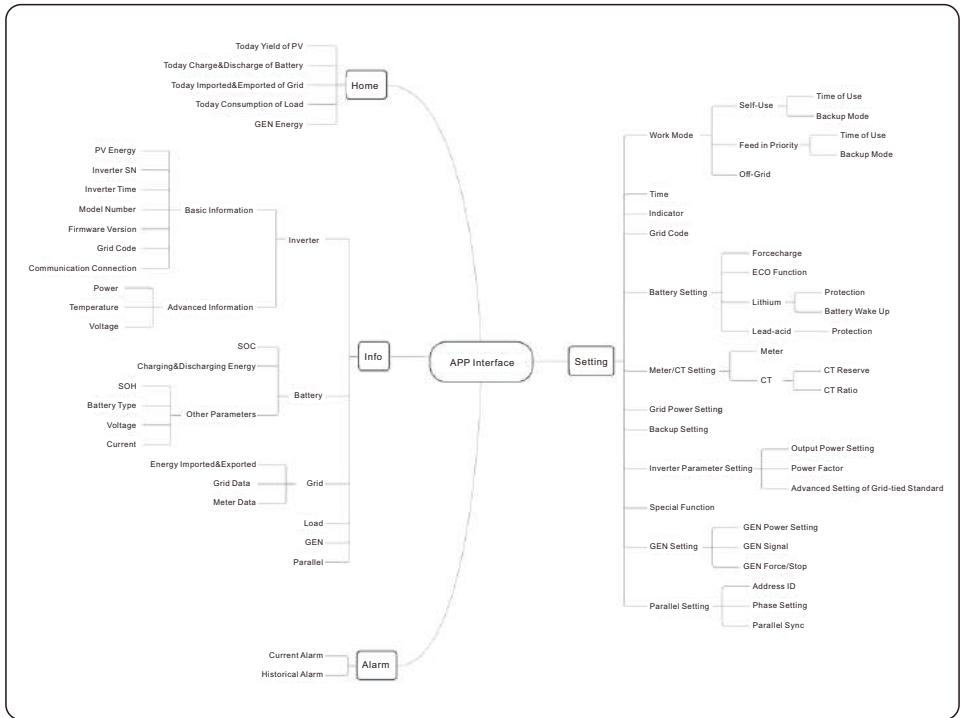

## 6.4.2 Home

The home page can display the working state, Today Yield of PV, Today Imported/Exported of Grid, Today Charged/Discharged of Battery ,Today Consumption of household electricity and Today GEN yield. At the bottom of page are four submenus: Home, Info, Alarm and Settings.

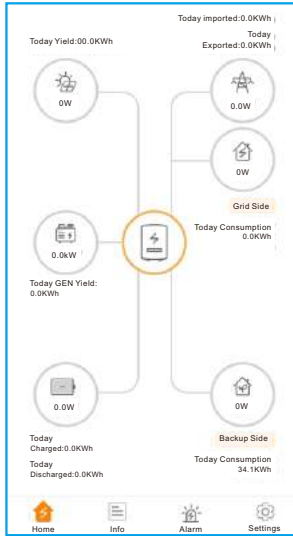

## 6.4.3 Information

The Info page breaks down into four categories: Inverter, Battery, Grid, and Load.

**Inverter:** inverter power production history, PV voltages and currents, inverter information (serial number, model number, and firmware version), grid code, and alarm code history.

There are two additional information in the inverter page:

**GEN Information:** generator power, today and total generator yield, and warning information.

**Parallel Information:** information includes inverter, battery, grid and load.

**Battery:** battery model and status, battery voltage and current.

**Grid:** power imported and exported, AC grid voltage, frequency, and amperage.

**Load:** power being consumed by the home loads and backup loads.

Inverter	Battery	Grid	Load
Total Yield			221kWh
14.2kWh Today Yield	191kWh This Month Yield	221kWh This Year Yield	
12.8kWh Yesterday Yield	30kWh Last Month Yield	0kWh Last Year Yield	
View Historical Yield >			
Total PV Input Power			865W
	Voltage	Current	Power
Pv1	432.6V	2.0A	865.20W
Pv2	0.0V	0.0A	0.00W
Inverter SN	103115022B100041		
Inverter Time	2022-12-23 15:32:03		
Rated Power	6kW		
Model Number	3115		
DSP Firmware Version	V2		
HMI Firmware Version	V1		
HMI Firmware Subversion	Vd		
Grid Code	G59/3		
Communication Connection	>		
Advanced Information	>		

Inverter	Battery	Grid	Load
49W Discharge Power	99% Battery SOC		
	Charged	Discharged	
Today	6.8kWh	0.2kWh	
Total	1830kWh	1536kWh	
Other Parameters(From BMS)			
Battery SOH	100%		
Battery Model	Dyness LV		
BMS Status	Normal		
Battery Voltage BMS	50.28V		
Battery Current BMS	0.0A		
BMS Charge Current Limit	10.0A		
BMS Discharge Current Limit	75.0A		
Other Parameters(From inverter)			
Battery Voltage	49.8V		
Battery Current	1.0A		
OverVoltage Protection Value	60.0V		
UnderVoltage Protection Value	42.0V		
Battery Equalization Voltage	53.5V		

Inverter	Battery	Grid	Load
	Exported	Imported	
Today	0.0kWh	0.0kWh	
Yesterday	0.0kWh	0.0kWh	
Total	1kWh	0kWh	
Grid Data			
Power	-1399W		
Voltage	220.8V		
Frequency	49.95Hz		

Inverter	Battery	Grid	Load
Grid Side			
Grid Load Power(Active)			0W
Total Grid Load Consumption			0kWh
Today Grid Load Consumption			0.0kWh
This Month Grid Load Consumption			0kWh
This Year Grid Load Consumption			0kWh
Backup Side			
Backup Load Power(Active)			2119W
Total Backup Load Consumption			1527kWh
Today Backup Load Consumption			34.2kWh
This Month Backup Load Consumption			1202kWh
This Year Backup Load Consumption			1527kWh

## 6.4.4 Alarm

The alarm page can display the current alarm and the historical alarm.

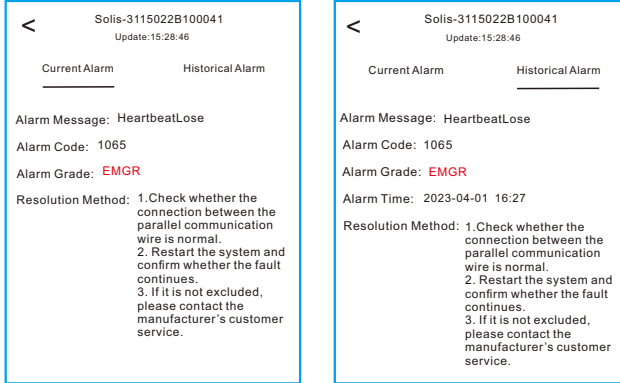

## 6.4.5 Settings

### Mode Setting

The interface can display the current work mode, Self-Use/Feed in Priority/Off-Grid. Please refer to page xxx for specific introduction.

### Battery Setting

**Battery Model:** select the battery model to be connected.

**Peak-shaving setting:** If the switch is enable, the power of force charging will be dynamically adjusted.

Few samples to be clear: (Forcecharge Limited Power Setting=4kW)

If the load=3kW,PV=0kW,P\_forcecharge=P\_Grid(4kW)-P\_Load(3kW)=1kW.

If the load=10kW,PV=0kW,P\_forcecharge=0kW,P\_Grid=P\_Load=10kW.

**ECO Function:** If PV power is lower than 100W and SOC falls below overdischarge SOC, the inverter will turn off the grid relays and IGBT switching. If forcecharge SOC is reached, it will connect back to grid and charge battery back to overdischarge SOC, then turn off again.

**Battery wake up:** After Battery wake up command, the inverter powers the DC battery port using Battery Wakeup Voltage and low AMP till BMS communication of battery will be restored and within awaken time.

**Over-discharge SOC:** When the battery is discharged to the over-discharge soc, the battery will nor discharge actively.(Due to the internal current, conduction, there is a small self-consumption power, if not charged for a long time, the SOC will slowly continue to decline.)

**Force-charge SOC:** Due to the battery power consumption, when the over-discharge SOC drops to the force-charge SOC, the inverter will directly charge the battery according to the maximum battery charging current until the battery SOC reaches the over-discharge SOC. (The charging power is not limited to sources, which may be from PV or from the grid. If “Charging from grid” is set to “Not Allow”, the charging logic may not be implemented.) It is not recommended to set the over-discharge & force-charge SOC to the same value, which may cause frequent charging and discharging.

**GEN\_Start\_SOC/Volt:** If SOC/Volt reaches GEN\_Start\_SOC/Volt, the generator can be started.

**GEN\_Exit\_SOC/Volt:** If SOC/Volt reaches GEN\_Exit\_SOC/Volt, the generator can be stopped.

Battery Setting	
Battery Model	PYLON_LV >
Peak-shaving Setting	<input type="checkbox"/>
Max. grid power when Forcecharging	500W >
Max. grid power when Forcecharging (Parallel)	0W >
ECO Function	<input type="checkbox"/>
Overdischarge SOC	20% >
Forcecharge SOC	10% >
Battery Overvoltage Protection Setting	60.0V >
Battery Undervoltage Protection Setting	42.0V >
GEN_Start_SOC	25% >
GEN_Exit_SOC	80% >
Battery Wake Up	>
Awaken Voltage	40.0V >
Awaken Time	20s >

Battery Setting	
Battery Model	Lead Acid >
Peak-shaving Setting	<input type="checkbox"/>
Max. grid power when Forcecharging	500W >
Max. grid power when Forcecharging (Parallel)	0W >
ECO Function	<input type="checkbox"/>
Battery Capacity	200Ah >
Max Charging Current	100.0A >
Max Discharging Current	100.0A >
Battery Overvoltage Protection Setting	60.0V >
Battery Undervoltage Protection Setting	42.0V >
Overdischarge Voltage	44.5V >
Force Voltage	43.8V >
GEN_Start_Volt	48.5V >
GEN_Exit_Volt	52.0V >
Equalization Voltage	56.4V >
Lead Acid TEMP CO	72mV/°C >
Environment temperature	Normal temper... >



## Meter/CT Setting

Meter Type need to be set. It must be based on the meter type that is actually connected to the inverter.

Meter Installation Location need to be set. It is suggested to install the meter at the system grid connection point and select "Meter in Grid"

If there is no meter connected for the moment, please select "No Meter" to avoid alarms.

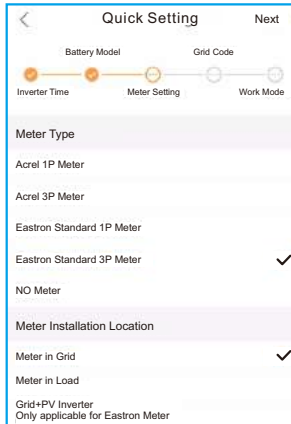

## Meter Recommend

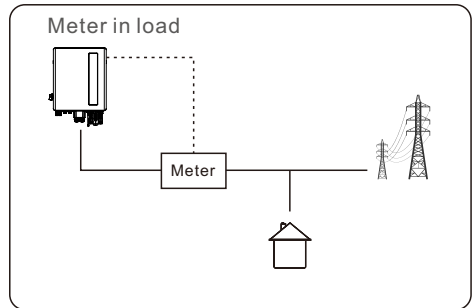
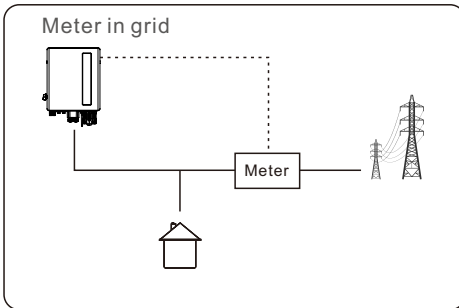

## Grid Power Setting

**System Export Power/Current:** This is the amount of power/current the inverter is permitted to export(or sell) back to the utility company. If you do not want the system exporting power, this setting must be configured.

**Failsafe Switch:** Enabling the Failsafe switch will mean that the inverter will not produce any P power if the inverter loses communication with the meter.

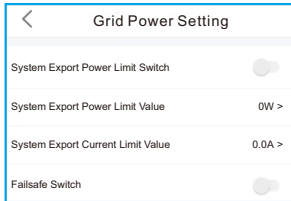

## Backup Setting

**Backup Voltage Setting:** This is the voltage designated to the backup loads in the event of a grid power loss.

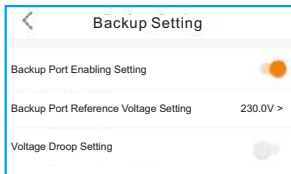

## Generator Setting

**With Generator:** Please turn it on if the generator is ready to work.

**GEN Power Setting:** GEN Rated Power/GEN Max.Charge Power.

**Generator Position:** Grid Port/GEN Port.

**Grid Port Powered By:** If the generator is connected in Grid Port and the generator works , please select "Generator".

**GEN Signal:** If the generator can automatic start-stop,turn on the switch, once the generator start condition is reached,the inverter will start the generator automatically.

**GEN Force:** If  $GEN\_Start\_SOC < SOC < GEN\_Exit\_SOC / GEN\_Start\_Volt < Volt < GEN\_Exit\_Volt$ , the generator can be forced to start.

**GEN Stop:** If  $GEN\_Start\_SOC < SOC < GEN\_Exit\_SOC / GEN\_Start\_Volt < Volt < GEN\_Exit\_Volt$ , the generator can be forced to stop.

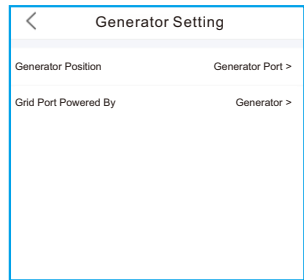
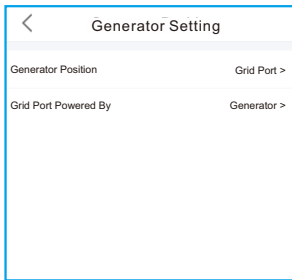
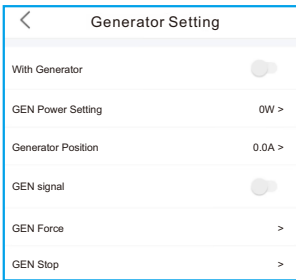

### Parallel Setting

**Parallel Mode:** Single/Parallel

**Address ID:** 1 to 6

**Manual Set Master/Slave:** Address ID 1 is Master, the others is Slave.

**Inverter Connected Phase Setting:** Single Phase(single phase system)/  
Phase A(Three Phase)/Phase B(Three Phase)/Phase C(Three Phase)

**Total number of hybrid inverters connected:** 0-6

**Parallel Sync:** The parameters of the master will be synchronized to the slaves, and some parameters of the slave cannot be set.

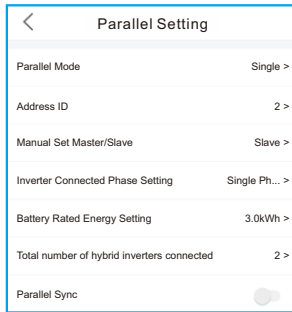

The inverter commissioning process has now been completed. It is recommended to monitor the system closely over the next week to ensure that everything is working as it should. Please refer to the Solis data logger manual for assistance with registering a new plant on SolisCloud.



**NOTE:**

A full factory reset can be done, if needed. This function can be found in the Special Setting Function menu within the Settings tab.

### Changed password

When the password of the owner or the installer needs to be reset, please long press the states indicator for 5s.

If the reset command is successfully triggered, the status indicator will be blue and blink for 3s at the frequency of 0.5s, then restore the original state of the indicator.

If the command fails to be triggered, the status indicator will be yellow and blink for 3s at the frequency of 0.5s, then restore the original state of the indicator.

If the command is successfully triggered, the Bluetooth password can be reset in the APP.

Solis S6 Series inverter does not require any regular maintenance. However, cleaning the heatsink will help the inverter dissipate heat and increase the lifetime of inverter. The dirt on the inverter can be cleaned with a soft brush.



**CAUTION:**

Do not touch the surface when the inverter is operating. Some parts may be hot and could cause burns. Turn OFF the inverter and let it cool down before you do any maintenance or cleaning of inverter.

The Screen and the LED status indicator lights can be cleaned with cloth if they are too dirty to be read.



**Note:**

Never use any solvents, abrasives, or corrosive materials to clean the inverter.

## 7.1 Smart O&M

In order to improve our products and provide you with higher quality services, this device has a built-in data logging module for collecting relevant information during operation (such as power generation data, fault data)

**Commitment:**

1. We will only collect, use and process your device information for the purpose of improving our products and services.
2. We will take all reasonable and feasible measures to ensure that no irrelevant information is collected and we will protect your device information.
3. We will not share, transfer or disclose the collected device information with any company, organization or individual.
4. When we stop operating products or services, we will stop collecting your device information in a timely manner.
5. If you do not want to provide such information, you can notify our company to turn off this function, which will not affect your normal use of other functions of the product.

Message Name	Information Description	Troubleshooting Suggestion
Off	Control device to shutdown	1. Turn on the device in the ON/OFF Setting.
LmtByEPM	The device's output is under controlled	<ol style="list-style-type: none"> <li>1. Confirm whether the inverter is connected to an external EPM/meter to prevent reverse current.</li> <li>2. Confirm whether the inverter is controlled by an external third-party device.</li> <li>3. Confirm whether the power setting of the inverter power control is limited.</li> <li>4. Verify settings in section 6.6.7 and check your meter readings.</li> </ol>
LmtByDRM	DRM Function ON	1. No need to deal with it.
LmtByTemp	Over temperature power limited	1. No need to deal with it, the device is in normal operation.
LmtByFreq	Frequency power limited	
LmtByVg	The device is in the Volt-Watt mode	<ol style="list-style-type: none"> <li>1. Due to the requirements of local safety regulations, when the grid voltage is high, the Volt-watt working mode is triggered, which generally does not need to be dealt with.</li> <li>2. Inverter factory test errors causing this mode to open, if you need to close, you can close this mode in LCD, set the process: Main menu → Advanced Settings → Password 0010 → STD mode settings → Working Mode → Working mode: NULL → Save and exit.</li> </ol>
LmtByVar	The device is in the Volt-Var mode of operation	<ol style="list-style-type: none"> <li>1. Due to the requirements of local safety regulations, when the grid voltage is high, the Volt-watt working mode is triggered, which generally does not need to be dealt with.</li> <li>2. Inverter factory test errors causing this mode to open, if you need to close, you can close this mode in LCD, set the process: Main menu → Advanced Settings → Password 0010 → STD mode settings → Working Mode → Working mode: NULL → Save and exit.</li> </ol>
LmtByUnFr	Under frequency limit	1. No need to deal with it.
Standby	Bypass run	
StandbySynoch	Off grid status to On grid status	
GridToLoad	Grid to load	

Message Name	Information Description	Troubleshooting Suggestion
Surge Alarm	On-site grid surge	1. Grid side fault, restart the device. If it is still not eliminated, please contact the manufacturer's customer service.
OV-G-V01	Grid voltage exceeds the upper voltage range	1. Confirm whether the power grid is abnormal. 2. Confirm that the AC cable is properly connected. 3. Restart the system and check if the fault persists.
UN-G-V01	Grid voltage exceeds the lower voltage range	
OV-G-F01	Grid frequency exceeds the upper frequency range	
UN-G-F01	Grid frequency exceeds the lower frequency range	
G-PHASE	Unbalanced grid voltage	
G-F-GLU	Grid voltage frequency fluctuation	
NO-Grid	No grid	
OV-G-V02	Grid transient overvoltage	
OV-G-V03	Grid transient overvoltage	1. Restart the system, confirm if that the fault continues.
IGFOL-F	Grid current tracking failure	1. Confirm whether the power grid is abnormal. 2. Confirm that the AC cable is properly connected. 3. Restart the system and check if the fault persists.
OV-G-V05	Grid voltage RMS instantaneous overvoltage fault	
OV-G-V04	Grid voltage exceeds the upper voltage range	
UN-G-V02	Grid voltage exceeds the lower voltage range	
OV-G-F02	Grid frequency exceeds the upper frequency range	
UN-G-F02	Grid frequency exceeds the lower frequency range	
NO-Battery	Battery is not connected	1. Check on information page 1 – Verify the battery voltage is within standards. 2. Measure battery voltage at plug.
OV-Vbackup	Inverting overvoltage	1. Check whether the backup port wiring is normal 2. Restart the system, confirm that the fault continues.
Over-Load	Load overload fault	1. Backup load power is too large, or some inductive load startup power is too large, need to remove some backup load, or remove the inductive load on the backup.

# 8. Troubleshooting

Message Name	Information Description	Troubleshooting Suggestion
BatName-FAIL	Wrong battery brand selection	1. Confirm whether the battery model selection is consistent with the actual one.
CAN Fail	CAN Fail	1. Can failure is a failure of communication between inverter and battery. Check cable conditions. Check to ensure you have it plugged in on the CAN port of the battery and inverter. Check that you are using the right cable. Some batteries require a special battery from the battery manufacturer.
OV-Vbatt	Battery overvoltage detected	1. Verify battery voltage is within standards. Measure battery voltage at inverter connection point. Contact your battery manufacturer for further service.
UN-Vbatt	Battery undervoltage detected	1. Restart the system and check if the fault persists. If it is still not eliminated, please contact the manufacturer's customer service.
Fan Alarm	Fan alarm	1. Check if the internal fan is working correctly or jammed.
OV-DC01 (1020 DATA:0001)	DC 1 input overvoltage	1. Check if the PV voltage is abnormal 2. Restart the system, confirm that the fault continues
OV-DC02 (1020 DATA:0002)	DC 2 input overvoltage	
OV-BUS (1021 DATA:0000)	DC bus overvoltage	1. Restart the system, confirm that the fault continues.
UN-BUS01 (1023 DATA:0001)	DC bus undervoltage	
UNB-BUS (1022 DATA:0000)	DC bus unbalanced voltage	
UN-BUS02 (1023 DATA:0002)	Abnormal detection of DC bus voltage	
DC-INTF. (1027 DATA:0000)	DC hardware overcurrent (1, 2, 3, 4)	1. Check if the DC wires are connected correctly without loose connection.
OV-G-I (1018 DATA:0000)	Aphase RMS value overcurrent	1. Confirm that the grid is abnormal. 2. Confirm that the AC cable connection is not abnormal. 3. Restart the system, confirm that the fault continues.
OV-DCA-I (1025 DATA:0000)	DC 1 average overcurrent	1. Restart the system, confirm that the fault continues.
OV-DCB-I (1026 DATA:0000)	DC 2 average overcurrent	
GRID-INTF. (1030 DATA:0000)	AC hardware overcurrent (abc phase)	



Message Name	Information Description	Troubleshooting Suggestion
DCInj-FAULT (1037 DATA:0000)	The current DC component exceeds the limit	<ol style="list-style-type: none"> <li>1. Confirm that the grid is abnormal.</li> <li>2. Confirm that the AC cable connection is not abnormal.</li> <li>3. Restart the system, confirm that the fault continues.</li> </ol>
IGBT-OV-I (1048 DATA:0000)	IGBT overcurrent	<ol style="list-style-type: none"> <li>1. Restart the system, confirm that the fault continues.</li> </ol>
OV-TEM (1032 DATA:0000)	Module over temperature	<ol style="list-style-type: none"> <li>1. Check whether the surrounding environment of the inverter has poor heat dissipation.</li> <li>2. Confirm whether the product installation meets the requirements.</li> </ol>
RelayChk-FAIL (1035 DATA:0000)	Relay failure	<ol style="list-style-type: none"> <li>1. Restart the system, confirm that the fault continues.</li> </ol>
UN-TEM (103A DATA:0000)	Low temperature protection	<ol style="list-style-type: none"> <li>1. Check the working environment temperature of the inverter.</li> <li>2. Restart the system to confirm if the fault continues.</li> </ol>
PV ISO-PRO01 (1033 DATA:0001)	PV negative ground fault	<ol style="list-style-type: none"> <li>1. Check whether the PV strings have insulation problems.</li> <li>2. Check whether the PV cable is damaged.</li> </ol>
PV ISO-PRO02 (1033 DATA:0002)	PV positive ground fault	
12Power-FAULT (1038 DATA:0000)	12V undervoltage failure	<ol style="list-style-type: none"> <li>1. Check current leakage to ground. Verify your grounding. Verify all wires are in good condition and not leaking current to ground.</li> </ol>
ILeak-PRO01 (1034 DATA:0001)	Leakage current failure 01 (30mA)	
ILeak-PRO02 (1034 DATA:0002)	Leakage current failure 02 (60mA)	
ILeak-PRO03 (1034 DATA:0003)	Leakage current failure 03 (150mA)	
ILeak-PRO04 (1034 DATA:0004)	Leakage current failure 04	
ILeak_Check (1039 DATA:0000)	Leakage current sensor failure	
GRID-INTF02 (1046 DATA:0000)	Power grid disturbance 02	<ol style="list-style-type: none"> <li>1. Confirm whether the grid is seriously distorted.</li> <li>2. Check whether the AC cable is connected reliably.</li> </ol>
OV-Vbatt-H/ OV-BUS-H (1051 DATA:0000)	Battery overvoltage hardware failure / VBUS	<ol style="list-style-type: none"> <li>1. Check if the battery circuit breaker is tripping.</li> <li>2. Check if the battery is damaged.</li> </ol>

Message Name	Information Description	Troubleshooting Suggestion
OV-ILLC (1052 DATA:0000)	LLC hardware overcurrent	1. Check whether the backup load is overloaded. 2. Restart the system, confirm that the fault continues.
INI-FAULT (1031 DATA:0000)	AD zero drift overlink	1. Restart the system, confirm that the fault continues.
DSP-B-FAULT (1036 DATA:0000)	The master-slave DSP communication is abnormal	
AFCI-Check (1040 DATA:0000)	AFCI self-test failure	
ARC- FAULT (1041 DATA:0000)	AFCI failure	1. Verify connections are tight within your PV system. Arc fault settings can be changed in advanced settings if further adjustment is necessary.

Table 8.1 Fault message and description



**NOTE:**

If the inverter displays any alarm message as listed in Table 8.1; please turn off the inverter and wait for 5 minutes before restarting it .  
If the failure persists, please contact your local distributor or the service center.

Please keep ready with you the following information before contacting us.

1. Serial number of Solis Singles Phase Inverter;
2. The distributor/dealer of Solis Singles Phase Inverter (if available);
3. Installation date.
4. The description of the problem together with necessary information, pictures, attachment.
5. The PV array configuration (e.g. number of panels, capacity of panels, number of strings, etc.);
6. Your contact details.

# 9. Specifications

Technical Data	S6-EH1P3K-L-EU/BE	S6-EH1P3.6K-L-EU/BE
<b>Input DC (PV side)</b>		
Recommended max. PV power	4800W	5700W
Max. input voltage	600V	
Rated voltage	330V	
Start-up voltage	90V	
MPPT voltage range	90-520V	
Full load MPPT voltage range	105-520V	125-520V
Max. input current	16A/16A	
Max. short circuit current	24A/24A	
MPPT number/Max input strings number	2/2	
<b>Battery</b>		
Battery Type	Li-ion / Lead-acid	
Battery Voltage range	42 - 58V	
Battery Capacity	50 - 2000Ah	
Maximum Charging Power	3kW	3.6kW
Maximum Charge/discharge current	62.5A	75A
Communication	CAN/RS485	
<b>Output AC(Back-up)</b>		
Rated output power	3kW	3.6kW
Max. apparent output power	4.2 kVA, 60SEC	5 kVA, 60SEC
Back-up switch time	< 10ms	
Rated output voltage	1/N/PE, 220 V/230 V	
Rated frequency	50Hz/60Hz	
Rated output current	21.8 A	26.2 A
THDv(@linear load)	2%	
<b>Input AC (Grid side)</b>		
Input voltage range	187-253V	
Max. input current	20.5 A	24.6 A
Frequency range	45-55 Hz/ 55-65Hz	

# 9. Specifications

Technical Data	S6-EH1P3K-L-EU/BE	S6-EH1P3.6K-L-EU/BE
<b>Output AC(Grid side)</b>		
Rated output power	3kW	3.6kW
Max. apparent output power	3.3kVA	4kVA
Operation phase	1/N/PE	
Rated grid voltage	220 V/230 V	
The grid voltage range	187-253 V	
Rated grid frequency	50 Hz/60 Hz	
AC grid frequency range	45-55 Hz/55-65 Hz	
Rated grid output current	13.6 A/13.0 A	16.4 A/15.7 A
Max. output current	15.0 A	18.2 A
Power Factor	> 0.99 (0.8 leading - 0.8 lagging)	
THDi	<2%	
<b>Efficiency</b>		
Max efficiency	>97.0%	
EU efficiency	>96.2%	
BAT charged by PV Max. efficiency	>94.9%	
BAT charged/discharged to AC Max. efficiency	>94.33%/93.51%	
<b>Protection</b>		
Ground fault monitoring	Yes	
Residual current monitoring	Yes	
Integrated AFCI	Yes	
DC reverse polarity protection	Yes	
Protection class / Over voltage category	I / II	

# 9. Specifications

Technical Data	S6-EH1P3K-L-EU/BE	S6-EH1P3.6K-L-EU/BE
<b>General data</b>		
Dimensions(W/H/D)	405*480*205mm	
Weight	24.18kg	
Topology	High frequency insulation (for battery)	
Operation temperature range	-25°C ~ +60°C	
Ingress protection	IP66	
Cooling concept	Natural convection	
Max.operation altitude	4000m	
Grid connection standard	G98 or G99, VDE-AR-N 4105 / VDE V 0124, EN 50549-1, VDE 0126 / UTE C 15 / VFR:2019, RD 1699 / RD 244 / UNE 206006 / UNE 206007-1, CEI 0-21, C10/11, NRS 097-2-1, TOR, EIFS 2018.2, IEC 62116, IEC 61727, IEC 60068, IEC 61683, EN 50530, MEA, PEA	
Safty/EMC standard	IEC/EN 62109-1/-2, EN 61000-6-1/-2/-3/-4	
Wireless signal frequency range	2400-2483.5MHz	
Wireless max power	Bluetooth: 4dBm	
<b>Features</b>		
DC connection	MC4 connector	
AC connection	Quick connection plug	
Display	LED+APP	
Communication	RS485,CAN, Optional: Wi-Fi, GPRS, LAN*	
Warranty	5 years standard (extend to 20 years)	

# 9. Specifications

Technical Data	S6-EH1P4.6K-L-EU/BE	S6-EH1P5K-L-EU/BE
<b>Input DC (PV side)</b>		
Recommended max. PV power	7000W	8000W
Max. input voltage	600V	
Rated voltage	330V	
Start-up voltage	90V	
MPPT voltage range	90-520V	
Full load MPPT voltage range	160-520V	175-520V
Max. input current	16A/16A	
Max. short circuit current	24A/24A	
MPPT number/Max input strings number	2/2	
<b>Battery</b>		
Battery Type	Li-ion / Lead-acid	
Battery Voltage range	42 - 58V	
Battery Capacity	50 - 2000Ah	
Maximum Charging Power	4.6kW	5kW
Maximum Charge/discharge current	100A	105A
Communication	CAN/RS485	
<b>Output AC(Back-up)</b>		
Rated output power	4.6kW	5kW
Max. apparent output power	6.4 kVA, 60SEC	7 kVA, 60SEC
Back-up switch time	< 10ms	
Rated output voltage	1/N/PE, 220 V/230 V	
Rated frequency	50Hz/60Hz	
Rated output current	33.4 A	36.5 A
THDv(@linear load)	2%	
<b>Input AC (Grid side)</b>		
Input voltage range	187-253V	
Max. input current	31.4 A	34.1 A
Frequency range	45-55 Hz/ 55-65Hz	

# 9. Specifications

Technical Data	S6-EH1P4.6K-L-EU/BE	S6-EH1P5K-L-EU/BE
<b>Output AC(Grid side)</b>		
Rated output power	4.6kW	5kW
Max. apparent output power	4.6kVA	5.5kVA/5kVA(For Belgium)
Operation phase	1/N/PE	
Rated grid voltage	220 V/230 V	
The grid voltage range	187-253 V	
Rated grid frequency	50 Hz/60 Hz	
AC grid frequency range	45-55 Hz/55-65 Hz	
Rated grid output current	20.9 A/20.0 A	22.7 A/21.7 A
Max. output current	21.0 A	25.0 A
Power Factor	> 0.99 (0.8 leading - 0.8 lagging)	
THDi	<2%	
<b>Efficiency</b>		
Max efficiency	>97.5%	
EU efficiency	>96.2%	
BAT charged by PV Max. efficiency	>94.9%	
BAT charged/discharged to AC Max. efficiency	>94.33%/93.51%	
<b>Protection</b>		
Ground fault monitoring	Yes	
Residual current monitoring	Yes	
Integrated AFCI	Yes	
DC reverse polarity protection	Yes	
Protection class / Over voltage category	I / II	

# 9. Specifications

Technical Data	S6-EH1P4.6K-L-EU/BE	S6-EH1P5K-L-EU/BE
<b>General data</b>		
Dimensions(W/H/D)	405*480*205mm	
Weight	24.18kg	
Topology	High frequency insulation (for battery)	
Operation temperature range	-25°C ~ +60°C	
Ingress protection	IP66	
Cooling concept	Natural convection	
Max.operation altitude	4000m	
Grid connection standard	G98 or G99, VDE-AR-N 4105 / VDE V 0124, EN 50549-1, VDE 0126 / UTE C 15 / VFR:2019, RD 1699 / RD 244 / UNE 206006 / UNE 206007-1, CEI 0-21, C10/11, NRS 097-2-1, TOR, EIFS 2018.2, IEC 62116, IEC 61727, IEC 60068, IEC 61683, EN 50530, MEA, PEA	
Safty/EMC standard	IEC/EN 62109-1/-2, EN 61000-6-1/-2/-3/-4	
Wireless signal frequency range	2400-2483.5MHz	
Wireless max power	Bluetooth: 4dBm	
<b>Features</b>		
DC connection	MC4 connector	
AC connection	Quick connection plug	
Display	LED+APP	
Communication	RS485,CAN, Optional: Wi-Fi, GPRS, LAN*	
Warranty	5 years standard (extend to 20 years)	



# 9. Specifications

Technical Data	S6-EH1P6K-L-EU
<b>Input DC (PV side)</b>	
Recommended max. PV power	9600W
Max. input voltage	600V
Rated voltage	330V
Start-up voltage	90V
MPPT voltage range	90-520V
Full load MPPT voltage range	210-520V
Max. input current	16A/16A
Max. short circuit current	24A/24A
MPPT number/Max input strings number	2/2
<b>Battery</b>	
Battery Type	Li-ion / Lead-acid
Battery Voltage range	42 - 58V
Battery Capacity	50 - 2000Ah
Maximum Charging Power	6kW
Maximum Charge/discharge current	125A
Communication	CAN/RS485
<b>Output AC(Back-up)</b>	
Rated output power	6kW
Max. apparent output power	8 kVA, 60SEC
Back-up switch time	< 10ms
Rated output voltage	1/N/PE, 220 V/230 V
Rated frequency	50Hz/60Hz
Rated output current	40 A
THDv(@linear load)	2%
<b>Input AC (Grid side)</b>	
Input voltage range	187-253V
Max. input current	40 A
Frequency range	45-55 Hz/ 55-65Hz

# 9. Specifications

Technical Data	S6-EH1P6K-L-EU
<b>Output AC(Grid side)</b>	
Rated output power	6kW
Max. apparent output power	6.6kVA
Operation phase	1/N/PE
Rated grid voltage	220 V/230 V
The grid voltage range	187-253 V
Rated grid frequency	50 Hz/60 Hz
AC grid frequency range	45-55 Hz/55-65 Hz
Rated grid output current	27.3 A/26.1 A
Max. output current	30.0 A
Power Factor	> 0.99 (0.8 leading - 0.8 lagging)
THDi	<2%
<b>Efficiency</b>	
Max efficiency	>97.5%
EU efficiency	>96.2%
BAT charged by PV Max. efficiency	>94.9%
BAT charged/discharged to AC Max. efficiency	>94.33%/93.51%
<b>Protection</b>	
Ground fault monitoring	Yes
Residual current monitoring	Yes
Integrated AFCI	Yes
DC reverse polarity protection	Yes
Protection class / Over voltage category	I / II

Technical Data	S6-EH1P6K-L-EU
<b>General data</b>	
Dimensions(W/H/D)	405*480*205mm
Weight	24.18kg
Topology	High frequency insulation (for battery)
Operation temperature range	-25°C ~ +60°C
Ingress protection	IP66
Cooling concept	Natural convection
Max.operation altitude	4000m
Grid connection standard	G98 or G99, VDE-AR-N 4105 / VDE V 0124, EN 50549-1, VDE 0126 / UTE C 15 / VFR:2019, RD 1699 / RD 244 / UNE 206006 / UNE 206007-1, CEI 0-21, C10/11, NRS 097-2-1, TOR, EIFS 2018.2, IEC 62116, IEC 61727, IEC 60068, IEC 61683, EN 50530, MEA, PEA
Safety/EMC standard	IEC/EN 62109-1/-2, EN 61000-6-1/-2/-3/-4
Wireless signal frequency range	2400-2483.5MHz
Wireless max power	Bluetooth: 4dBm
<b>Features</b>	
DC connection	MC4 connector
AC connection	Quick connection plug
Display	LED+APP
Communication	RS485,CAN, Optional: Wi-Fi, GPRS, LAN*
Warranty	5 years standard (extend to 20 years)

\*WIFI communication function needs to use the data logger, LAN communication needs to cooperate with the upper PC.

Bluetooth

Frequency range:2400-2483.5MHz

Ginlong Technologies Co., Ltd.

No. 188 Jinkai Road, Binhai Industrial Park, Xiangshan, Ningbo,  
Zhejiang, 315712, P.R.China.

Tel: +86 (0)574 6578 1806

Fax: +86 (0)574 6578 1606

Email:info@ginlong.com

Web:www.ginlong.com

Please adhere to the actual products in case of any discrepancies in this user manual.

If you encounter any problem on the inverter, please find out the inverter S/N  
and contact us, we will try to respond to your question ASAP.



SunSpec  
Certified



Comply with CA Rule 21/  
Certified to UL 1741 SA  
Certified to UL Std. No. 1741-Second Edition  
& CSA-C22.2 No.107.1-16