



Essential SmartBright LED Downlight G2

DN027B LED9/NW D150 RD

Essential SmartBright G2 LED Downlight is value for money product with high efficacy, good quality and reliability. It offers multiple configurations from 300lm to 2000lm output, to replace conventional downlight. It can be used for shopping mall, retail store, residential and office. It's an ideal product family to distribute in trade market.

Product data

General Information	
Light source replaceable	No
Number of gear units	1 unit
Driver/power unit/transformer	PSU [Power supply unit]
Driver included	Yes
Optic type	110 [Beam angle 110°]
Connection	Flying leads/wires
Protection class IEC	Safety class II (II)
Warranty period	1 years
Constant light output	No

Operating and Electrical

Input voltage	220-240 V
Input frequency	50 or 60 Hz
Inrush current	15 A
Inrush time	0.198 ms
Power factor (min.)	0.7

Controls and Dimming	
Dimmable	No

Mechanical and Housing	
Housing material	Metal-Plastic
Reflector material	-
Optic material	Polycarbonate
Overall height	33 mm
Overall diameter	175 mm
Colour	White
Dimensions (height x width x depth)	33 x NaN x NaN mm (1.3 x NaN x NaN in)

Approval and Application	
Ingress protection code	IP20 [Finger-protected]
Mech. impact protection code	IK02 [0.2 J standard]

Initial Performance (IEC Compliant)	
Initial luminous flux	900 lm
Luminous flux tolerance	+/-10%
Init. Corr. Colour Temperature	4000 K

Essential SmartBright LED Downlight G2

Init. Color rendering index	80
Initial chromaticity	SDCM<5
Initial input power	11 W
Power consumption tolerance	+/-10%

Over Time Performance (IEC Compliant)

Median useful life L70B50	20000 h
---------------------------	---------

Application Conditions

Ambient temperature range	-20 to +40 °C
---------------------------	---------------

Product Data

Full product code	871016330884599
-------------------	-----------------

Order product name	DN027B LED9/NW D150 RD
EAN/UPC – product	8710163308845
Order code	30884599
Numerator – quantity per pack	1
Numerator – packs per outer box	24
Material no. (12NC)	911401811897
Net weight (piece)	0.270 kg



Dimensional drawing

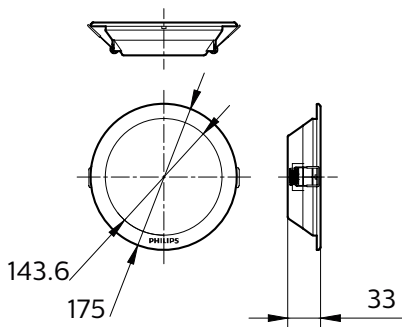

DN027B

Photometric data

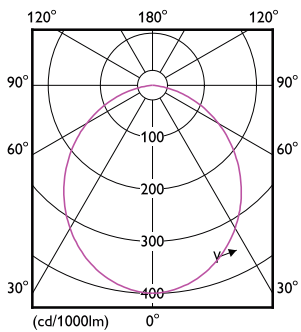

Downlight DN027B LED9 NW D150 RD

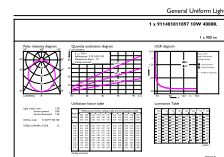

Downlight DN027B LED9 NW D150 RD

Essential SmartBright LED Downlight G2

