



Overview

Applicable scope

The new NXC AC contactors feature a novel appearance and a compact structure. They are mainly used for frequent starts and control of AC motors as well as remote circuit making /breaking. They can also be combined with appropriate thermal overload relays to form electromagnetic starters.

Compliant standards: IEC/EN 60947-1, IEC/EN 60947-4-1, IEC/EN 60947-5-1.

Parameters

- Rated operation current I_e : 6A~630A
- Rated operation voltage U_e : 220V~690V
- Rated insulation voltage: 690V (NXC-06M~100), 1000V (NXC-120~630)
- Number of poles: 3P and 4P (only for NXC-06M~12M)
- Coil control method: AC (NXC-06(M)~225), DC (NXC-06M~12M), AC/DC (NXC-265~630)
- Installation method: NXC-06M~100 rail and screw installation, NXC-120~630 screw installation

Operation and installation conditions

Type	Operation and installation conditions
Installation class	III
Pollution degree	3
Compliant standards	IEC/EN 60947-1, IEC/EN 60947-4-1, IEC/EN 60947-5-1
Certification mark	CE
Enclosure protection degree	NXC-06M~38: IP20; NXC-40~100: IP10; NXC-120~630: IP00
Ambient temperature	Operation temperature limits: -35°C~+70°C. Normal operation temperature range: -5°C~+40°C. The 24-hour average temperature should not exceed +35°C. For use beyond the normal operation temperature range, see "Instructions for use in abnormal conditions" in the annex.
Altitude	Not exceeding 2000 m above sea level
Atmospheric conditions	The relative humidity should not exceed 50% at the upper temperature limit of +70°C. A higher relative humidity is allowed at a lower temperature, e.g. 90% at +20°C. Special precautions should be taken against occasional condensation due to humidity variations.
Installation conditions	The angle between the installation surface and the vertical surface should not exceed $\pm 5^\circ$.
Shock and vibration	The product should be installed in places without significant shaking, shock, and vibration.

Description

NXC AC contactor

NXC	-	12	/N	230V	50Hz
Model		Rated current	Special function	Coil voltage	Frequency
		06, 09, 12, 16, 18, 22, 25, 32, 38, 40, 50, 65, 75, 85, 100, 120, 160, 185, 225, 265, 330, 400, 500, 630	/N: Reversible contactor None: Standard contactor	24V, 36V, 48V, 110V, 127V, 220V, 230V, 240V, 380V, 415V, 440V, 480V, 660V (AC: 06A~225A; AC/DC: 265A~630A)	50Hz, 60Hz, 50/60Hz

Note: 06A-100A products contain one NO auxiliary contact and one NC auxiliary contact. 120A-630A products contain two NO auxiliary contacts and two NC auxiliary contacts.

NXC miniature 3P AC contactor

NXC	-	06M	10	/Z	/N	230V	50Hz
Model		Rated current	Auxiliary contact	Coil form	Special function	Coil voltage	Frequency
		06M, 09M, 12M	10: NO 01: NC	/Z: DC control coil None: AC control coil	/N: Reversible contactor None: Standard contactor	AC: 24V, 36V, 48V, 110V, 127V, 220V, 230V, 240V, 380V, 415V, 440V, 480V, 660V DC: 24V, 48V, 110V, 220V	50Hz, 60Hz, 50/60Hz

NXC miniature 4P AC contactor

NXC	-	06M	/22	/Z	/N	230V	50Hz
Model		Rated current	4P main contact combination	Coil form	Special function	Coil voltage	Frequency
		06M, 09M, 12M	/22: 2 NO and 2 NC main contacts /04: 4 NC main contacts /40: 4 NO main contacts	/Z: DC control coil None: AC control coil	/N: Reversible contactor None: Standard contactor	AC: 24V, 36V, 48V, 110V, 127V, 220V, 230V, 240V, 380V, 415V, 440V, 480V, 660V DC: 24V, 48V, 110V, 220V	50Hz, 60Hz, 50/60Hz

Model example: NXC-12 240V 50Hz represents an AC contactor under AC-3 utilization category that provides a rated current of 12A at a main circuit voltage of 380V/400V/415V. Each contactor body contains one NO auxiliary contact and one NC auxiliary contact. The coil control voltage and frequency are 240V AC and 50Hz respectively.

NXC AC contactor selection table

Motor power kW			Maximum operation current A (AC-3 380V/400V)	Number of contacts contained in the contactor body		Contactor model
220V/230V/240V	380V/400V	660V/690V		NO	NC	
1.5	2.2	3	6	1	0	NXC-06M10
1.5	2.2	3	6	0	1	NXC-06M01
1.5	2.2	3	6	1	1	NXC-06
2.2	4	4	9	1	0	NXC-09M10
2.2	4	4	9	0	1	NXC-09M01
2.2	4	5.5	9	1	1	NXC-09
3	5.5	4	12	1	0	NXC-12M10
3	5.5	4	12	0	1	NXC-12M01
3	5.5	7.5	12	1	1	NXC-12
3	7.5	7.5	16	1	1	NXC-16
4	7.5	10	18	1	1	NXC-18
5.5	11	11	22	1	1	NXC-22
5.5	11	15	25	1	1	NXC-25
7.5	15	18.5	32	1	1	NXC-32
9	18.5	18.5	38	1	1	NXC-38
11	18.5	30	40	1	1	NXC-40
15	22	37	50	1	1	NXC-50
18.5	30	37	65	1	1	NXC-65
22	37	37	75	1	1	NXC-75
22	37	45	85	1	1	NXC-85
25	45	45	100	1	1	NXC-100
37	55	80	120	2	2	NXC-120
45	75	100	160	2	2	NXC-160
55	90	100	185	2	2	NXC-185
63	110	110	225	2	2	NXC-225
75	132	160	265	2	2	NXC-265
90	160	200	330	2	2	NXC-330
132	200	300	400	2	2	NXC-400
160	250	335	500	2	2	NXC-500
200	335	350	630	2	2	NXC-630

Coil voltage specification table

NXC-06M~12M								
AC (V) 50Hz	24	36	48	110	127	220 230 240	380	415
AC (V) 60Hz	24	36	48	110	127	220	380	415
DC (V)	24	-	48	110	-	220	-	-



NXC-06~100								
AC (V) 50Hz	24	36	48	110	127	220 230 240	380	415
AC (V) 60Hz	24	36	48	110	127	220	380	415

NXC-120~225								
AC (V) 50Hz	-	-	-	-	110	127	220 230 240	380
AC (V) 60Hz	-	-	-	-	110	127	220	380

NXC-265~630								
AC/DC (V)	-	-	-	-	110~127	220~240	380~415	-



Parameters

Main circuit parameters and technical performance

Contactor model		NXC-06M	NXC-09M	NXC-12M	NXC-06	NXC-09	NXC-12	NXC-16	NXC-18	NXC-22	
											
Conventional thermal current I _{th} (A)		20	20	20	20	20	25	25	32	32	
Rated insulation voltage U _i (V)		690									
Rated impulse withstand voltage U _{imp} (kV)		6				8					
Rated making capacity		Making current: 10×I _e (AC-3) or 12×I _e (AC-4)									
Rated breaking capacity		Breaking current: 8×I _e (AC-3) or 10×I _e (AC-4)									
Rated operation current I _e (A)	220V/230V/240V	AC-3	6	9	12	6	9	12	16	18	22
		AC-4	6	9	12	6	9	12	16	18	22
	380V/400V/415V	AC-3	6	9	12	6	9	12	16	18	22
		AC-4	6	9	9	6	9	12	12	18	18
	660V/690V	AC-3	3.8	4.9	4.9	3.8	6.6	8.9	8.9	12	14
		AC-4	3.8	4.9	4.9	3.8	6.6	8.9	8.9	12	12
Rated control power (kW)	AC-3	220V/230V/240V	1.5	2.2	3	1.5	2.2	3	3	4	5.5
		380V/400V/415V	2.2	4	5.5	2.2	4	5.5	7.5	7.5	11
		660V/690V	3	4	4	3	5.5	7.5	7.5	10	11
Electrical life (cycles)		AC-3	1.2×10 ⁶								
Mechanical life (cycles)		1.2×10 ⁷									
Main contact		3 NO, 4 NO, 2 NO+2 NC				3 NO					
Fuse supplied for SCPD		NT00-20	NT00-20	NT00-25	NT00-20	NT00-20	NT00-25	NT00-25	NT00-32	NT00-32	
Matching thermal overload relay		Model	NXR-12			NXR-25					
Built-in auxiliary contact		3P	1 NO or 1 NC			1 NO+1 NC					
		4P	-								



Control circuit		Contactor model	NXC-06M	NXC-09M	NXC-12M	NXC-06	NXC-09	NXC-12	NXC-16	NXC-18	NXC-22
Main circuit connection	Cable connection (mm ²)	Prefabricated flexible wire	1	1~2.5			1~4			1.5~6	
			2	1~1.5			1~2.5			1.5~4	
		Hard wire	1	1~2.5			1~4			1.5~6	
			2	1~2.5			1~4			1.5~6	
	Size of fastening screw		M3				M3.5			M3.5	
Tightening torque (N·m)		0.8				0.8			0.8		
Control circuit connection	Cable connection (mm ²)	Prefabricated flexible wire	1	1~2.5			1~4				
			2	1~1.5			1~2.5				
		Hard wire	1	1~2.5			1~4				
			2	1~2.5			1~4				
	Size of fastening screw		M3				M3.5				
Tightening torque (N·m)		0.8				0.8					

Contactor model		NXC-06M	NXC-09M	NXC-12M	NXC-06	NXC-09	NXC-12	NXC-16	NXC-18	NXC-22
Coil control power supply	AC 50Hz	24, 36, 48, 110, 127, 220, 230, 240, 380, 415			24, 36, 48, 110, 127, 220, 230, 240, 380, 415					
	DC	24, 48, 110, 220			-					
Control voltage	Pull-in	(75%~120%) U _s			(70%~120%) U _s					
	Release	AC: (20%~70%) U _s ; DC: (10%~70%) U _s			(20%~65%) U _s					
Coil average power (VA)	Start	25~40			40~60					40~60
	Hold	2~7			9.5					9.5
Heat dissipation (W)	AC	1~3			1~3					1~3
	DC	-			-					-

Contactor model		NXC-25	NXC-32	NXC-38	NXC-40	NXC-50	NXC-65	NXC-75	NXC-85	NXC-100		
												
Conventional thermal current I _{th} (A)		40	50	50	60	80	80	90	100	110		
Rated insulation voltage U _i (V)		690										
Rated impulse withstand voltage U _{imp} (kV)		8										
Rated making capacity		Making current: 10×I _e (AC-3) or 12×I _e (AC-4)										
Rated breaking capacity		Breaking current: 8×I _e (AC-3) or 10×I _e (AC-4)										
Rated operation current I _e (A)	220V/230V/240V	AC-3	25	32	38	40	50	65	75	85	100	
		AC-4	25	32	38	40	50	65	75	85	100	
	380V/400V/415V	AC-3	25	32	38	40	50	65	75	85	100	
		AC-4	25	32	32	40	50	65	75	85	100	
	660V/690V	AC-3	18	22	22	34	39	42	42	49	49	
		AC-4	18	22	22	34	39	42	42	49	49	
Rated control power	AC-3 (kW)	220V/230V/240V	5.5	7.5	9	11	15	18.5	22	22	25	
		380V/400V/415V	11	15	18.5	18.5	22	30	37	37	45	
		660V/690V	15	18.5	18.5	30	37	37	37	45	45	
Electrical life (cycles)		AC-3	1.2×10 ⁶			1×10 ⁶		0.8×10 ⁶				
		AC-4	See electrical life curve									
Mechanical life (cycles)		1×10 ⁷				0.9×10 ⁷			0.65×10 ⁷			
Main contact		3 NO										
Fuse supplied for SCPD		gG40	gG50	gG50	gG63	gG80	gG80	gG100	gG100	gG125		
Matching thermal overload relay		Model	NXR-25	NXR-38		NXR-100						
Built-in auxiliary contact		3P	1 NO+1 NC									
		4P	-									

Control circuit		Contactor model	NXC-25	NXC-32	NXC-38	NXC-40	NXC-50	NXC-65	NXC-75	NXC-85	NXC-100	
Main circuit connection	Cabling (mm ²)	Prefabricated flexible wire	1	1.5~10			6~25		10~35			
			2	1.5~6			4~10		6~16			
		Hard wire	1	1.5~6			6~25		10~35			
			2	1.5~6			4~10		6~16			
	Size of fastening screw		M4				M8		M8			
Tightening torque (N·m)		1.2				6		6				
Control circuit connection	Cabling (mm ²)	Prefabricated flexible wire	1	1~4								
			2	1~2.5								
		Hard wire	1	1~4								
			2	1~4								
	Size of fastening screw		M3.5									
Tightening torque (N·m)		0.8										

Contactor model		NXC-25	NXC-32	NXC-38	NXC-40	NXC-50	NXC-65	NXC-75	NXC-85	NXC-100	
Coil control power supply	AC 50Hz	24, 36, 48, 110, 127, 220, 230, 240, 380, 415									
Control voltage	Pull-in	(70%~120%) U _s									
	Release	(20%~65%) U _s									
Coil average power (VA)	Start	50~70			160~210			190~250			
	Hold	8~11.4			13~25			17~30			
Heat dissipation (W)	AC	1~3			4~8			6~10			
	DC	-									

Contactor model		NXC-120	NXC-160	NXC-185	NXC-225	NXC-265	NXC-330	NXC-400	NXC-500	NXC-630	
											
Conventional thermal current I _{th} (A)		200	200	275	275	315	380	450	630	700	
Rated insulation voltage U _i (V)		1000									
Rated impulse withstand voltage U _{imp} (kV)		12									
Rated making capacity		Making current: 10×I _e (AC-3) or 12×I _e (AC-4)									
Rated breaking capacity		Breaking current: 8×I _e (AC-3) or 10×I _e (AC-4)									
Rated operation current I _e (A)	220V/230V/240V	AC-3	120	160	185	225	265	330	400	500	630
		AC-4	120	160	160	185	265	330	330	500	500
	380V/400V/415V	AC-3	120	160	185	225	265	330	400	500	630
		AC-4	120	160	160	185	265	330	330	500	500
	660V/690V	AC-3	86	107	107	118	170	235	303	353	400
		AC-4	86	107	107	107	137	170	235	303	353
Rated control power (kW)	AC-3	220V/230V/240V	37	45	55	63	75	90	132	160	200
		380V/400V/415V	55	75	90	110	132	160	200	250	335
		660V/690V	80	100	100	110	160	200	300	335	350
Electrical life (cycles)		AC-3	1.2×10 ⁶				0.8×10 ⁶				
		AC-4	See electrical life curve								
Mechanical life (cycles)		0.6×10 ⁷									
Main contact		3 NO									
Fuse supplied for SCPD		gG224	gG224	gG315	gG315	gG400	gG425	gG500	gG800	gG950	
Matching thermal overload relay		Model	NXR-200			NXR-630					
Built-in auxiliary contact		3P	2 NO+2 NC								
		4P	-								

Control circuit		Contactor model	NXC-120	NXC-160	NXC-185	NXC-225	NXC-265	NXC-330	NXC-400	NXC-500	NXC-630			
Main circuit connection	Cable connection (mm ²)	Prefabricated flexible wire	1	10~150										
			2	10~75										
		Hard wire	1	10~150				50~240						
			2	10~75				50~240						
	Size of fastening screw			M6	M8	M10								
Tightening torque (N·m)			10				14							
Control circuit connection	Cable connection (mm ²)	Prefabricated flexible wire	1	1~4										
			2	1~2.5										
		Hard wire	1	1~4										
			2	1~4										
	Size of fastening screw			M3.5										
Tightening torque (N·m)			0.8											

Contactor model		NXC-120	NXC-160	NXC-185	NXC-225	NXC-265	NXC-330	NXC-400	NXC-500	NXC-630	
Coil control power supply	AC 50Hz	110, 127, 220, 230, 240, 380				Common for AC and DC: 110, 127, 220, 230, 240, 380					
	DC	-									
Control voltage	Pull-in	(75%~120%)U _s				(75%~120%)U _s					
	Release	(20%~70%)U _s				(10%~70%)U _s					
Coil average power (VA)	Start	500				600				800	
	Hold	50				11				11	
Heat dissipation (W)	AC	30~50				3~6				3~7	
	DC	-				3~6				3~7	

Accessories

Accessory diagrams

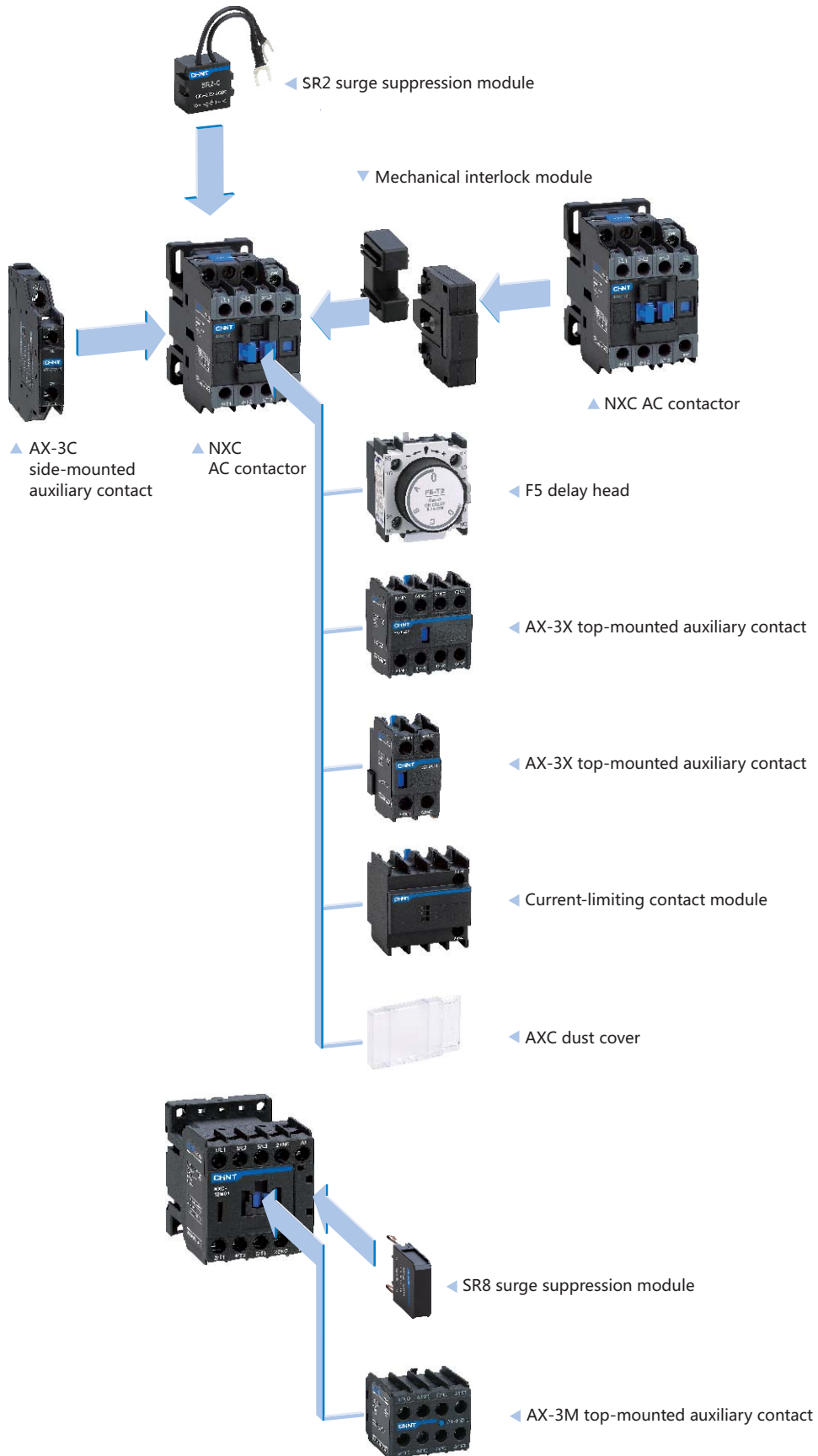

Accessory Description

Top-mounted auxiliary contact

AX - 3X /	11	AX - 3M /	11
Auxiliary contact model	NO and NC auxiliary contact combination	Auxiliary contact model	NO and NC auxiliary contact combination
Applicable to 6A-630A AC contactor product	11, 20, 02 22, 13, 31 04, 40	Applicable to NXC-06M ~12M AC contactor product	11, 20, 02 22, 13, 31 04, 40

Side-mounted auxiliary contact

AX - 3C /	11	B
Side-mounted auxiliary contact model	NO and NC contact combination	None: Standard model, applicable to 6A~225A AC contactor
	11	B: Expanded model, applicable to 265A~630A AC contactor

Dust cover

AXC	1
Dust cover	1: Used for NXC-06~22, NXC-120~630 2: Used for NXC-25~38 3: Used for NXC-40~65 4: Used for NXC-75~100

Air delay head

F5 /	T	4
Air delay head model	Delay type	Delay range
	T: Power-on delay D: Power-off delay	0: 0.1~3s 2: 0.1~30s 4: 10~180s



Accessory selection table (auxiliary contact)

Contactor	Optional accessory	Accessory model	Contact combination
NXC-06M~12M	AX-3M top-mounted auxiliary contact	AX-3M/20	2NO+0NC
		AX-3M/11	1NO+1NC
		AX-3M/02	0NO+2NC
		AX-3M/40	4NO+0NC
		AX-3M/31	3NO+1NC
		AX-3M/22	2NO+2NC
		AX-3M/13	1NO+3NC
		AX-3M/04	0NO+4NC
NXC-06~225	AX-3X top-mounted auxiliary contact	AX-3X/20	2NO+0NC
		AX-3X/11	1NO+1NC
		AX-3X/02	0NO+2NC
		AX-3X/40	4NO+0NC
		AX-3X/31	3NO+1NC
		AX-3X/22	2NO+2NC
		AX-3X/13	1NO+3NC
		AX-3X/04	0NO+4NC
	AX-3C side-attached auxiliary contact	AX-3C/11	1NO+1NC
	NXC-265~630	AX-3X top-mounted auxiliary contact	AX-3X/20
AX-3X/11			1NO+1NC
AX-3X/02			0NO+2NC
AX-3X/40			4NO+0NC
AX-3X/31			3NO+1NC
AX-3X/22			2NO+2NC
AX-3X/13			1NO+3NC
AX-3X/04			0NO+4NC
AX-3C side-attached auxiliary contact		AX-3C/11B	1NO+1NC

Accessory selection table (air delay head)

Contactor	Optional accessory	Accessory model	Contact combination	Delay range (s)
NXC full series (except for NXC-06M~12M)	F5 air delay head	F5-T0	1NO+1NC	0.1~3
		F5-T2	1NO+1NC	0.1~30
		F5-T4	1NO+1NC	10~180
		F5-D0	1NO+1NC	0.1~3
		F5-D2	1NO+1NC	0.1~30
		F5-D4	1NO+1NC	10~180

Accessory selection table (dust cover)

Contactor	Optional accessory
NXC-06~22, NXC-120~630	AXC-1 dust cover
NXC-25~38	AXC-2 dust cover
NXC-40~65	AXC-3 dust cover
NXC-75~100	AXC-4 dust cover

Main parameters and technical performance indicators of accessories

Item		Main technical parameters		
Rated operation current (V)		To 690		
Rated insulation voltage (V)		690		
Conventional thermal current Ith (A)		10		
Rated making capacity (A)		Breaking current 10 Ie (AC-15) or Ie (DC-13)		
Short-circuit protection		gG fuse: 10A		
Control capacity	Auxiliary contact	AC-15	380V/400V/415V	1.5A
		DC-13	220V/230V/240V	0.3A
	F5 air delay head	AC-15	660V/380V	0.52A/0.95A
		DC-13	220V	0.15A
Compliant standards		IEC/EN 60947-5-1		
Product certification		CE		
Enclosure protection degree		IP 20		
Cable connection (mm ²)	Flexible wire without cold-pressed terminal	1~4		
		1~4		
	Flexible wire with cold-pressed terminal	1~4		
		1~2.5		
	Hard wire	1~4		
		1~4		
Fastening screw size		M3.5, M3 (AX-3M)		
Tightening torque (N·m)		0.8		

Derivative products

Name	Reversible AC contactor
Reversible AC contactor	

Dimensions and installation

NXC-06M-12M

Dimensions and installation

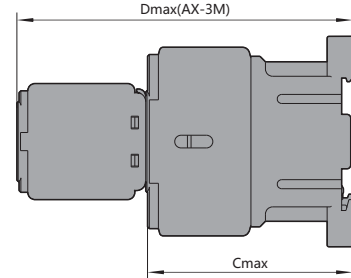
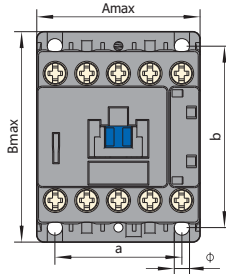

Model	Amax	Bmax	Cmax	Dmax	a	b	Φ
NXC-06M-12M	45.5	59	58	94	35±0.35	50±0.48	4.2
NXC-06M/4-12M/4	45.5	59	58	94	35±0.35	50±0.48	4.2
NXC-06M/Z-12M/Z	45.5	59	70	106	35±0.35	50±0.48	4.2
NXC-06M/4/Z-12M/4/Z	45.5	59	70	106	35±0.35	50±0.48	4.2

NXC-06-22

Dimensions and installation

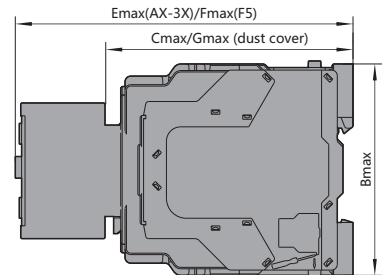
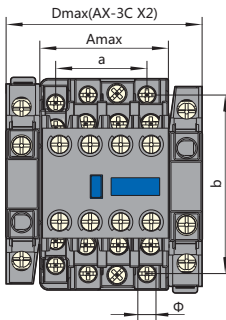

NXC-25-100

Dimensions and installation

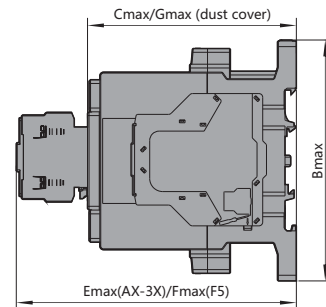
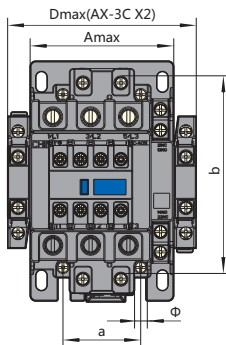

Model	Amax	Bmax	Cmax	Dmax	Emax	Fmax	Gmax	a	b	Φ
NXC-06-22	45.5	75	88	70	126.5	146.5	90	35±0.31	62±0.31	4.5
NXC-25-38	56.5	87	93	81	131.5	151.5	95	40±0.31	48±0.31	4.5
NXC-40-65	77	129	118	102	156.5	176.5	121	40±0.31	105±0.31	6.5
NXC-75-100	87	132	127	112	165.5	185.5	129	40±0.28	105±0.57	6.5

NXC-120-225

Dimensions and installation

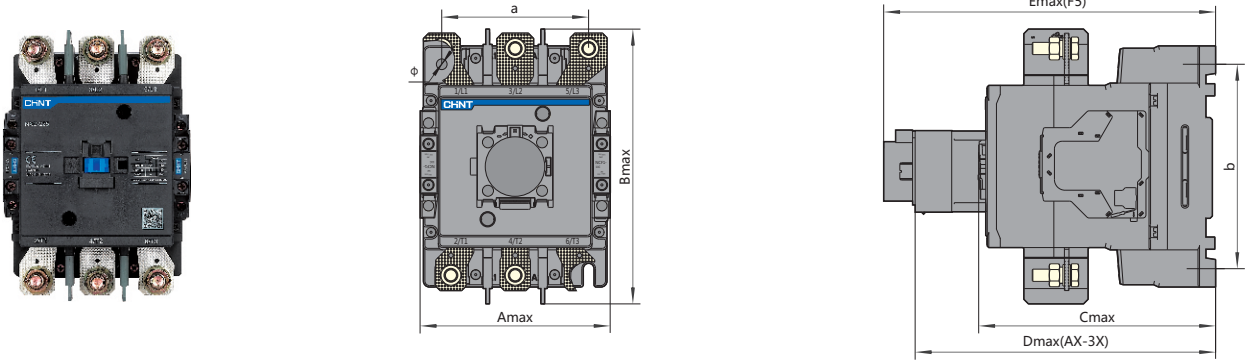

NXC-265-400

Dimensions and installation

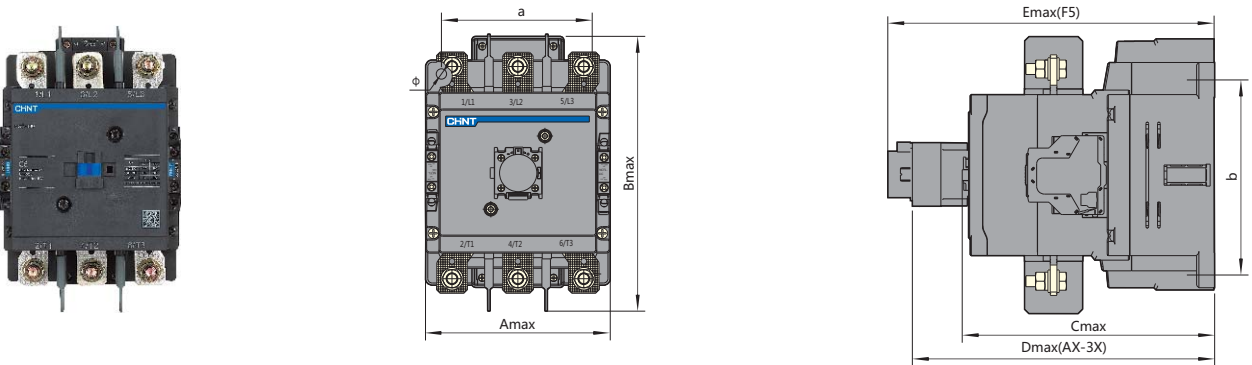

NXC-500-630

Dimensions and installation

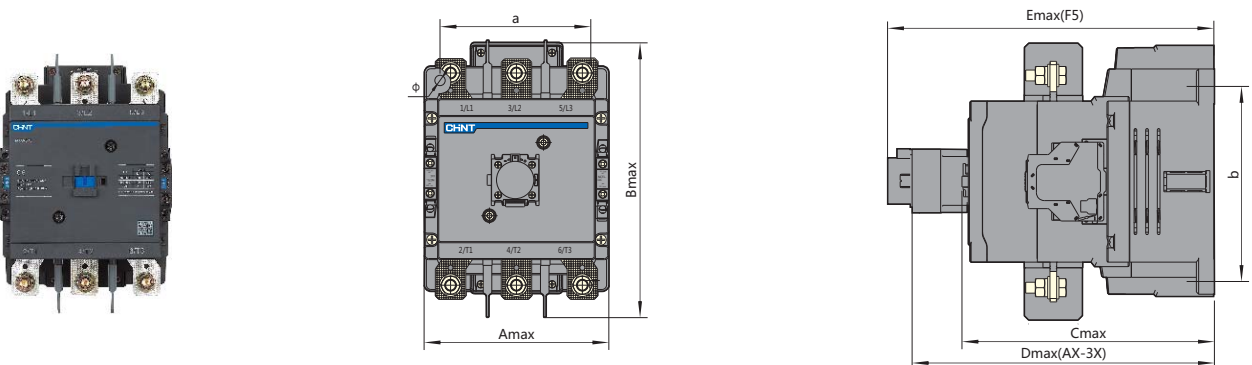

Model	Amax	Bmax	Cmax	Dmax	Emax	a	b	Φ
NXC-120-225	127	182	158	196.5	216.5	96±0.5	133.6±0.8	7
NXC-265-400	150	236	207	245.5	265.5	120±0.5	180±0.8	9
NXC-500-630	165	248	225	263.5	283.5	130±0.5	180±0.8	9

Wiring diagrams

NXC-06~100

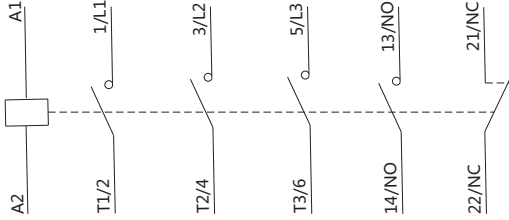

NXC-120~630

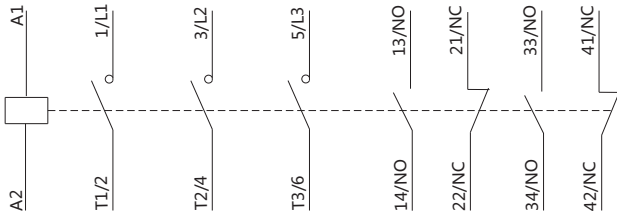

AX-3X/11

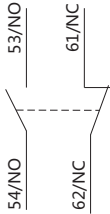

AX-3X/20

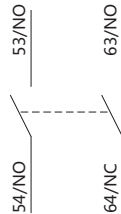

AX-3X/02

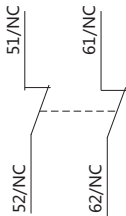

AX-3X/22

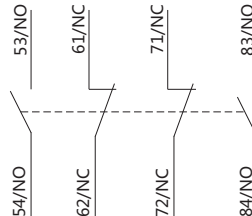

AX-3X/13

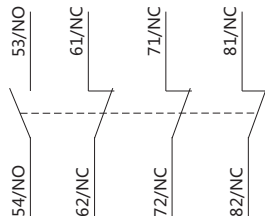

AX-3X/40

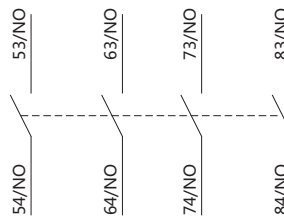

AX-3X/04

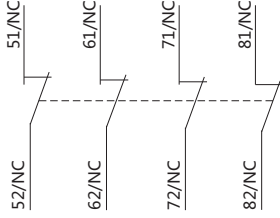

AX-3X/31

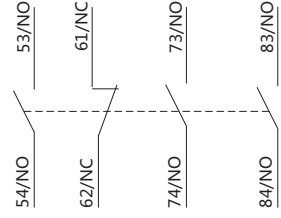

AX-3M/11

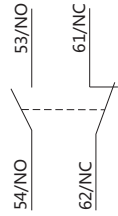

AX-3M/20

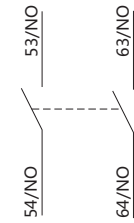

AX-3M/02

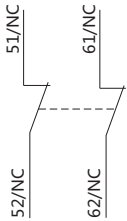

AX-3M/22

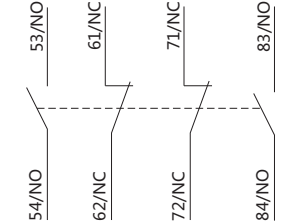

AX-3M/13

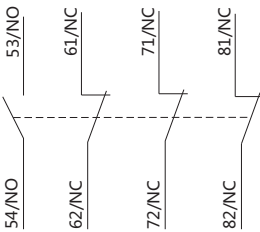

AX-3M/40

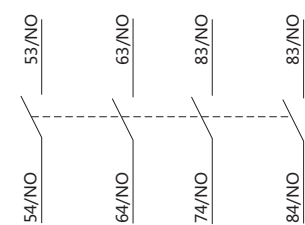

AX-3M/04

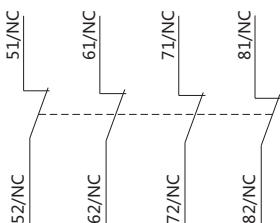

AX-3M/31

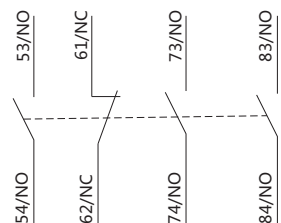

Annex I: Instructions for use in abnormal conditions

Instructions for use of correction factors in high altitude areas

- IEC/EN 60947-4-1 standard defines the relation between altitude and impulse withstand voltage. An altitude of 2000 m above sea level or lower has no significant impact on product performance.
- At an altitude higher than 2000 m, air cooling effect and decrease of rated impulse withstand voltage have to be considered. In this case, design and use of products have to be negotiated by the manufacturer and the user.
- The correction factors for rated impulse withstand voltage and rated operation current for altitudes higher than 2000 m are given in the following table. The rated operation voltage remains unchanged.

Altitude (m)	2000	3000	4000
Rated impulse withstand voltage correction factor	1	0.88	0.78
Rated operation current correction factor	1	0.92	0.9

Instructions for use under abnormal ambient temperature

- IEC/EN 60947-4-1 standard defines normal operation temperature range for products. Use of products in the normal range will not cause significant impact on their performance.
- At an operation temperature higher than +40°C, the tolerable temperature rise of products needs to be reduced. Both rated operation current and number of contactors in standard products have to be decreased to prevent product damage, shortened service life, lower reliability, or impact on control voltage. At a temperature lower than -5°C, freezing of insulation and lubrication grease should be considered to prevent action failures. In these cases, design and use of products have to be negotiated by the manufacturer and the user.
- The correction factors for different rated operation current under operation temperature higher than +55°C are given in the following table. The rated operation voltage remains unchanged.

Ambient temperature (°C)	55	60	65	70
Correction factor	1	0.93	0.875	0.75

- At the temperature range of +55°C~+70°C, the pull-in voltage range of AC contactors is (90%~110%)Us, and (70%~120%)Us is the results of cold status tests at 40°C ambient temperature.

Instructions for derating during use in corrosive environment

Impact on metal parts

Chlorine Cl₂, nitrogen dioxide NO₂, hydrogen sulfide H₂S, sulfur dioxide SO₂

Copper: The thickness of copper sulfide coating in chlorine environment will be twice that in normal environment conditions. This is also the case for environments with nitrogen dioxide.

Silver: When used in SO₂ or H₂S environment, the surface of silver or silver coated contacts will become dark due to formation of a silver sulfide coating.

This will lead to higher contact temperature rise and may damage to the contacts.

In humid environments where Cl₂ and H₂S coexist, the coating thickness will increase by 7 times. With presence of both H₂S and NO₂, the silver sulfide thickness will increase by 20 times.

Considerations during product selection

In refinery, steel, paper, artificial fiber (nylon) industry or other industries using sulphur, equipment may experience vulcanization (also called oxidization in some industrial sectors). Equipment installed in machine rooms is not always well protected from oxidization. Short inlets are often used to ensure that the pressure in such rooms is slightly higher than atmospheric pressure, which helps reduce pollutions due to external factor to a certain degree. However, after operation for 5 to 6 years, the equipment still experience rust and oxidization inevitably.

Hence in operation environments with corrosive gas, the equipment needs to be used with derating. The derating coefficient relative to the rated value is 0.6 (up to 0.8). This helps reduce rate of accelerated oxidization due to temperature rise.

Instructions for use with parallel poles

- In case of parallel poles, the rated current of such poles needs to be corrected to make up for distribution of long-term unstable current, as shown in the table below:

Number of parallel poles	2	3	4
Correction factor	1.6	2.25	2.8

Annex II: Utilization category description

Different types of power-consuming equipment may have significantly different loading characteristics and current changes during making/breaking, hence they have different requirements for contactors. IEC 60947-1 standard defines contactor utilization categories that are indicated by one or more of the following use conditions:

- Current, indicated with multiples of rated current
- Voltage, indicated with multiples of rated voltage
- Power factor or time constant
- Short-circuit performance
- Selectivity
- Other use conditions (if applicable)

NXC AC contactors mainly include the following categories:

Utilization categories of AC main circuit

AC-1 type
This type is used for AC loads with a power factor higher than or equal to 0.95.
Examples: heating, power distribution.
AC-2 type
This type is used for start reverse braking and inching of slip ring motors.
During closing, the contactor makes a start current that is about 2.5 times motor rated current.
During opening, the contactor must break the start current at a voltage lower than or equal to the main supply voltage.
AC-3 type
This type is used for breaking normally started squirrel cage motors.
During closing, the contactor makes a start current that is about 7 times motor rated current.
During opening, the contactor breaks motor rated current. In this case, the voltage at the contactor wire terminal is about 20% of main supply voltage. The breaking process is not harsh.
Examples: all standard squirrel cage motors such as those in elevator, escalator, conveyance belt, air compressor, pump, mixer, and air conditioner.
AC-4 type
This type is used for reverse braking and inching of squirrel motors and sling ring motors.
The contactor makes a current that is 5 to 7 times rated motor current, and breaks the same current at higher voltage. At lower motor RPMs, the voltage breaking is as harsh as main voltage.
Examples: printing machinery, wire drawing machine, tower crane, crane, metallurgy

Control circuit utilization categories.

DC-13 type
This type of system is used for starting, reverse current braking, and inching of DC shunt excited machines. The duration is equal to or less than 2 ms.
This type is used for switching electromagnetic loads.
AC-15 type
This type is used for switching electromagnetic loads. The pull-in power during closing of electromagnet is higher than 72VA.
Examples: operation coil of switch contactors.

