

Power Quality Analyser UMG 103-CBM

(from firmware 2.0)

User manual and technical data



Janitza electronics GmbH
Vor dem Polstück 6
35633 Lahnu | Germany
Support +49 6441 9642-22
info@janitza.com | www.janitza.com

Janitza[®]

UMG 103-CBM

Power Quality Analyzer

Measurement device for recording energy quantities

Doc. no.: 2.057.013.1.e

Date: 05/2023

The German version is the original edition of the documentation

Subject to technical changes.

The contents of our documentation have been compiled with great care and reflect the current state of the information available to us. Nonetheless, we wish to point out that updates of this document are not always possible at the same time as technical refinements are implemented in our products. Please see our website under www.janitza.com for the current version.

Please see our website under www.janitza.com for the current version.

TABLE OF CONTENTS

1. Information on the device and the user manual	8
1.1 Disclaimer	8
1.2 Copyright notice	8
1.3 Technical changes	8
1.4 About this user manual	8
1.5 Defective device/disposal	9
2. Safety	10
2.1 Display of warning notices and safety information	10
2.2 Hazard levels	10
2.3 Product safety	11
2.4 Dangers when handling the device	11
2.5 Electrically qualified personnel	12
2.6 Warranty in the event of damage	12
2.7 Safety information for handling current transformers	12
3. Product description	14
3.1 Device description	14
3.2 Incoming goods inspection	14
3.3 Intended use	15
3.4 Performance characteristics	16
3.5 EU conformity declaration	16
3.6 FCC Declaration of Conformity	16
3.7 Scope of delivery	17
3.8 Accessories	17
3.9 Measuring method	18
3.10 Transformer	18
3.11 Operating concept	18
3.12 GridVis® network analysis software	18
4. Structure of the device	20
4.1 Front panel and controls	20
4.2 LEDs display patterns	21
4.3 Identification of the device (rating plate)	22
5. Mounting	24
5.1 Installation location	24
5.2 Mounting orientation	24
6. Grid systems	25

7. Installation	26
7.1 Nominal voltages	26
7.1.1 Three-phase four-conductor network with grounded neutral conductor	26
7.2 Circuit breaker	27
7.3 Supply voltage	27
7.4 Voltage measurement	28
7.4.1 Overvoltage	29
7.4.2 Frequency	29
7.4.3 Connection variants for voltage measurement	29
7.5 Current measurement	30
7.5.1 Connection variants for current measurement	31
7.5.2 Ammeter	32
7.5.3 Current direction	32
7.5.4 Summation current measurement	32
8. Connection and PC connections	34
8.1 Connection variants	34
8.2 RS-485 interface	35
8.3 Shielding	35
8.4 Bus structure	36
8.5 Termination resistors	36
9. Configuration	38
9.1 Current and voltage transformer	38
9.2 Device address	39
9.3 RS-485	39
10. Commissioning	40
10.1 Measured voltage / supply voltage	40
10.2 Measured current	41
10.3 Direction of rotary field	42
10.3.1 Fundamentals on the phasor diagram	42
10.3.2 Checking of voltage and current inputs by means of phasor diagram	43
10.4 Control of the power measurement	44
10.5 Checking measurement	44
10.6 Checking individual power	44
10.7 Checking summation power	44
10.8 Energy meters - clearing minimum and maximum values	45
10.9 Overrange	45

10. 10	“Drag indicator” function	46
10. 11	Internal synchronization	46
10. 12	External synchronization	47
10. 13	Recording the measured values	49
10. 14	Comparator	50
11.	Service and maintenance	51
11. 1	Repairs and calibration	51
11. 2	Front panel foil	51
11. 3	Service	51
11. 4	Battery	51
11. 5	Device adjustment	51
11. 6	Firmware update	52
12.	Procedure in the event of a malfunction	53
13.	Technical data	54
13. 1	Technical data	54
13. 2	Measuring accuracy	57
13. 3	Modbus addresses of frequently used measured values	58
13. 3. 1	Number formats	59
13. 3. 2	Note on saving measured values and configuration data	59
13. 4	Dimensional drawings	60
13. 5	Connection example	61

1. Information on the device and the user manual

1.1 Disclaimer

Compliance with the informational products for the device is a prerequisite for safe operation and attaining the stated performance characteristics and product features.

Janitza electronics GmbH assumes no liability for bodily injury, material damage or financial losses which result from disregard of the informational products.

Ensure that your informational products are readily accessible in a legible form.

1.2 Copyright notice

© 2021 - Janitza electronics GmbH - Lahnau.
All rights reserved.

Any reproduction, processing, distribution or other use of this informational product, in whole or in part, is prohibited.

All trademarks and the rights arising from them are the property of the respective owners of these rights.

1.3 Technical changes

- Make sure that your device matches the user manual.
- This user manual applies to the UMG 103-CBM.
- First read and understand the documents associated with the product.
- Keep the documents associated with the product available for the entire service life and pass them on to any possible subsequent users.
- Find out about device revisions and the associated modifications of the documentation associated with your product at www.janitza.de.

1.4 About this user manual

If you have questions, suggestions or ideas for improvement of the user manual, please let us know via email at: info@janitza.de.

INFORMATION

This user manual describes the UMG 103-CBM and provides information on the operation of the device. Also consult the additional documentation relevant for this user manual, such as:

- Installation instructions.
 - Data sheet.
 - Safety information.
 - Online help for the network visualization software GridVis®.
-

1.5 Defective device/disposal

Before sending **defective devices, modules or components** back to the manufacturer for testing:

- Contact the manufacturer's Support department.
- Send devices, modules or components complete with all accessories.
- When doing so, please bear the terms for transportation in mind.

INFORMATION

Please return defective or damaged devices to Janitza electronics GmbH in accordance with the shipping instructions for air or road freight (complete with accessories).

Observe special regulations for devices with built-in batteries or rechargeable batteries!

Do not attempt to open or repair the device (the component) on your own because otherwise all warranty claims become invalid!

For the **Disposal** of the device please observe national regulations! Dispose of individual parts, as applicable, depending on their composition and existing country-specific regulations, e.g. as

- Electronic waste,
- Batteries and rechargeable batteries.
- Plastics.
- Metals.

Engage a certified disposal company to handle scrapping as needed.

Information on service and maintenance of your device can be found in chapter „11. Service and maintenance“ on page 51

2. Safety

The chapter on Safety contains information which must be observed to ensure your personal safety and avoid material damage.

2.1 Display of warning notices and safety information

The warning notices shown below

- are found throughout all of the documentation,
- can be found on the devices themselves,
- indicate potential risks and hazards,
- underscore aspects of the information provided that clarifies or simplifies procedures.



The additional symbol on the device itself indicates an electrical danger that can result in serious injuries or death.



This general warning symbol draws attention to a possible risk of injury. Be certain to observe all of the information listed under this symbol in order to avoid possible injury or even death.



2.2 Hazard levels

Warning and safety information is marked by a warning symbol, and the hazard levels are shown as follows, depending on the degree of hazard:

⚠ DANGER
Warns of an imminent danger which, if not avoided, results in serious or fatal injury.

⚠ WARNING
Warns of a potentially hazardous situation which, if not avoided, could result in serious injury or death.

⚠ CAUTION
Warns of an immediately hazardous situation which, if not avoided, can result in minor or moderate injury.

ATTENTION
Warns of an immediately hazardous situation which, if not avoided, can result in material or environmental damage.

ⓘ INFORMATION

Indicates procedures in which there is **no** hazard of personal injury or material damage.

2.3 Product safety

The device reflects current engineering practice and accepted safety standards, but hazards can arise nonetheless.

Observe the safety regulations and warning notices. If notices are disregarded, this can lead to personal injury and/or damage to the product.

Every type of tampering with or use of this device,

- which goes beyond the mechanical, electrical or other operating limits can lead to personal injury and/or damage to the product;
- constitutes “misuse” and/or “negligence” under the product’s warranty and thus voids the warranty for any possible resulting damage.

Read and understand the user manual before installing, operating, maintaining and using the device.

Only operate the device when it is in perfect condition and in compliance with this user manual and the associated, included documents. Send defective devices back to the manufacturer in compliance with proper transport conditions. Retain the user manual throughout the service life of the device and keep it at hand for consultation.

When using the device, also observe the legal and safety regulations for your system that are applicable for the respective use case.

2.4 Dangers when handling the device

When operating electric devices, it is unavoidable for certain parts of these devices to conduct hazardous voltage. Consequently, severe bodily injury or material damage can occur if they are not handled properly.

Therefore, when handling our devices, always observe the following:

WARNING

Disregarding the connection conditions of the Janitza measurement devices or their components can lead to injuries and even death or to material damage!

- Do not use Janitza measurement devices or components for critical switching, control or protection applications where the safety of persons and property depends on this function.
- Do not carry out switching operations with the Janitza measurement devices or components without prior inspection by your plant manager with specialist knowledge! In particular, the safety of persons, material assets and the applicable standards must be taken into account!

WARNING

Risk of injury due to electrical voltage!

Severe bodily injury or death can result! Therefore please abide by the following:

- **Switch off your installation before commencing work! Secure it against being switched on! Check to be sure it is de-energized! Ground and short circuit! Cover or block off adjacent live parts!**
- **During operation and troubleshooting (especially for DIN rail devices), check your system for dangerous voltages and switch these off if necessary!**
- **Wear protective clothing and protective equipment in accordance with applicable guidelines when working on electrical systems!**
- **Before making connections to the device/the component, ground the device by means of the ground wire connection, if present.**
- **Do not touching bare or stripped leads that are energized! Equip stranded conductors with wire ferrules!**
- **Hazardous voltages can be present in all circuitry parts that are connected to the power supply.**
- **Protect wires, cables and devices with a suitable line circuit breaker/fuse!**
- **Never switch off, remove or tamper with safety devices!**
- **There can still be hazardous voltages present in the device or in the component even after it has been disconnected from the supply voltage (capacitor storage).**
- **Do not operate equipment with current transformer circuits when open.**
- **Only connect screw terminals with the same number of poles and design!**
- **Do not exceed the limit values specified in the user manual and on the rating plate! This must also be observed during testing and commissioning.**
- **Take note of the safety and warning notices in the documents that belong to the device!**

2.5 Electrically qualified personnel

To avoid bodily injury and material damage, only electrically qualified personnel are permitted to work on the devices and their components, modules, assemblies, systems and current circuits who have knowledge of:

- the national and international accident prevention regulations,
- safety technology standards,
- installation, commissioning, operation, disconnection, grounding and marking of electrical equipment,
- the requirements concerning personal protective equipment.

Electrically qualified persons within the scope of the technical safety information of all documents associated with the device and its components are persons who can furnish proof of qualification as an electrically skilled person.

 WARNING
<p>Warning against unauthorized manipulation or improper use of the device or its components! Opening, dismantling or unauthorized manipulation of the device and its components which goes beyond the mechanical, electrical or other operating limits indicated can lead to material damage or injury, up to and including death.</p> <ul style="list-style-type: none"> · Only electrically qualified personnel are permitted to work on the devices and their components, assemblies, systems and current circuits. · Always use your device or component only in the manner described in the associated documentation. · If there is discernible damage, send the device or the component back to the manufacturer!

2.6 Warranty in the event of damage

Any unauthorized tampering with or use of the device constitutes “misuse” and/or “negligence” under the product’s warranty and thus voids the warranty of any possible resulting damage. In this regard, please take note of chap., “Warning” on page 11 page 15

2.7 Safety information for handling current transformers

 WARNING
<p>Risk of injury due to large currents and high electrical voltage on the current transformers! Current transformers operated while open on the secondary side (high voltage peaks pose a hazard when touched) can result in severe bodily injury or death.</p> <ul style="list-style-type: none"> · Avoid operating the current transformers while open; short circuit the unloaded transformers! · Before interrupting the current supply, short circuit the secondary connections of the current transformers. Switch any test switches that automatically short circuit the secondary lines of the current transformers to the “Test” status (Check the test switch/short circuiting connection beforehand)! · Only use current transformers with basic insulation to IEC 61010-1:2010! · Caution, even current transformers rated as safe for open operation can pose a hazard when touched during operation while open! · Make sure that screw terminals for the current transformer connection on the device are adequately tightened! · Comply with the information and provisions in the documentation of your current transformers!

 CAUTION
<p>Risk of injury or damage to the meter due to high measurement currents at the connections of the current transformers! High measurement currents can cause temperatures of up to 80 °C (176 °F) on the connections of the current transformers</p> <ul style="list-style-type: none"> · Use wiring that is designed for an operating temperature of at least 80 °C (176 °F)! · The current transformers can be hot even after the power supply has been switched off. Allow the connections of the current transformers and the connecting cables to cool down before touching them!

3. Product description

3.1 Device description

The device is a compact energy analyzer and is suitable for:

- Measurements and calculations of electrical quantities such as voltage, current, power, energy, harmonics current in building installations, on distribution boards, circuit breakers and busbar trunking systems.
- Measurements of voltages and currents from the same network.
- Measurements in low-voltage networks (3-phase 4-conductor systems) in which nominal voltages of up to 277 V from conductors to ground and surge voltages of overvoltage category III occur.
- current measurement via external $\dots/1$ A or $\dots/5$ A current transformers
- Installation in stationary switch cabinets or small distribution boards, in any mounting orientation.
- Reading out measurement results via an interface.
- Mains failures of max. 80 ms at a mains voltage of 230 VAC are bridged.

i INFORMATION

The device's suitability for measurements in medium and high voltage networks is limited because it obtains the supply voltage from the measured voltage and loads the voltage transformer with a non-linear current.

! CAUTION

Malfunction and damage of the device or risk of injury due to improper connection.

Improperly connected devices can deliver incorrect measured values, damage the device or pose a risk of injury to persons.

Observe the following:

- **That measured voltages and currents come from the same network.**
- **Do not use the device for measuring direct current!**
- **Ground current-conducting switchboards!**

3.2 Incoming goods inspection

Safe and trouble-free operation of this device and its components presupposes proper transport, proper storage, set-up and assembly as well as operation and maintenance in addition to compliance with the safety information and warning notices.

Exercise due caution when unpacking and packing the device, do not use force and only use suitable tools.

Before installing the device, please check the following:

- Its flawless mechanical condition by visual inspection.
- The scope of delivery for completeness.

If it can be assumed that safe operation of the device is no longer possible:

- Disconnect the device from operation immediately!
- Secure the device against being switched on again!

It can be assumed that safe operation is no longer possible if the device, for example:

- Has visible damage.
- No longer functions despite an intact power supply.
- Was subjected to extended periods of unfavorable conditions (e.g. storage outside of the permissible climate thresholds without adjustment to the room climate, condensation, etc.) or transport stress (e.g. falling from an elevated position, even without visible external damage, etc.).

3.3 Intended use

The device is:

- for use in the industrial sector.
- Intended for installation in switchboard cabinets and small installation distributors.
- Not intended for installation in vehicles! Use of the device in non-stationary equipment constitutes an exceptional environmental condition and is only permissible by special agreement.
- Not intended for installation in environments with harmful oils, acids, gases, vapors, dusts, radiation, etc.
- Designed as an interior meter.

Safe and trouble-free operation of the device requires proper transport, storage, assembly, installation, operation and maintenance.

3.4 Performance characteristics

General

- DIN rail device with dimensions of (WxHxD) 71.5 x 90 x 46 mm
- Mounting on DIN rail 35 mm, 4 TE
- Connection via screw terminals
- Setting via coding switch
- 3 voltage measurement inputs (300 V, CAT III)
- 3 current measurement inputs (via current transformer)
- Data memory 4 MByte flash
- RS-485 interface (Modbus RTU)
- Clock and battery

Measurement uncertainty

- Active energy, measurement uncertainty class 0.5S S for ..1/5 A transformers
- Active energy, measurement uncertainty class 1 for ..1A transformer
- Reactive energy, class 2

Measurement

- Measurement in TN and TT networks
- Continuous sampling of the voltage and current measurement inputs
- True effective value measurement (TRMS)
- Measurement of reactive distortion power
- Sampling frequency 5.4 kHz
- Measurement of positive, negative and zero sequence component
- Measurement of harmonics current, 1st to 40th for U and I
- Measurement of distortion factors THD-U /THD-I

3.5 EU conformity declaration

Please see the EU declaration of conformity posted at www.janitza.de for the laws, standards and directives applied by Janitza electronics GmbH for the devices. The CE conformity marking requirements for the device arise from the EU conformity declaration and the laws, standards and directives mentioned therein.

3.6 FCC Declaration of Conformity



The device:

- complies with Part 15 of the FCC Rules for Class B digital devices (limits to protect against harmful interference in a residential installation).
- generates, uses and can radiate high-frequency energy
- can cause harmful interference to radio communications if not installed and used properly. There is no guarantee that interference will not occur in a particular installation.

If there is radio or television reception interference, which can be determined by turning the device on and off, proceed as follows:

- Align or reposition the receiving antenna.
- Increase the distance between the device and the radio/television receiver.
- Connect the device and the radio/television receiver in different circuits.
- if necessary, contact Janitza support or a radio/television technician.

Code of Federal Regulations, Title 47, Part 15, Subpart B - Unintentional Radiators.

3.7 Scope of delivery

Quantity	Part. no.	Designation
1	52 28 001	UMG 103-CBM
1	33 03 345	Installation instructions
1	33 03 342	Supplement "Safety Information"
1	33 03 346	"GridVis Software" Quick Guide
1	52 28 250	Accessories pack UMG 103-CBM

Tab. Scope of delivery

3.8 Accessories

Quantity	Part. no.	Designation
1	18 08 094	RS-485, external termination resistor, 120Ω
1	15 06 024	RS-485 repeater, isolated
1	15 06 015	Interface converter RS-485 <-> RS-232
1	15 06 107	Interface converter RS-485 <-> USB

INFORMATION

- All supplied options and design variants are described on the delivery note.

The following apply for the battery used in the device:



CAUTION

- **In case of damage, return devices with a soldered battery to the manufacturer, observing proper transport conditions!**

3.9 Measuring method

The device measures:

- Continuously and calculates all effective values using in a 200 ms interval.
- The true RMS value (TRMS) of the voltages and currents applied to the measuring inputs.

3.10 Transformer

For Janitza measurement devices and components, use **only** current transformers intended for measuring purposes ("transformers")!

"Transformers", unlike "protection transformers", go into saturation at high current peaks. "Protection transformers" do not have this saturation behavior and can therefore significantly exceed the rated values in the secondary circuit. This can overload the current measurement inputs of the measurement devices!

Furthermore, please note that Janitza measurement devices and components are **not** to be used for critical switching, control or protection applications (protective relays)! Observe the safety and warning information in the „2.3 Product safety“ on page 11 and „7. Installation“ on page 26 chapters!

3.11 Operating concept

The operating concept of the measurement device incorporates the following methods:

- **2 coding switches** for setting the device address
- The **GridVis network analysis and programming software**® for programming and analysis of data.
- The **Modbus protocol and the Modbus address list** to configure and read out data. A standard Modbus address list is available at www.janitza.de.

3.12 GridVis® network analysis software

The GridVis® software (download at www.janitza.de) is the perfect tool for the configuration, readout and analysis of measurement data.

Performance characteristics of the GridVis® software

- Configure and read out data from your measurement device.
- Graphic display of measured values.
- Store measurement data in databases.
- Analyze measurement data that has been read out.
- Create reports.

Connections to the PC (GridVis® software)

Connections for communication between the PC and the measurement device can be found in chap. „Warning“ on page 11, „Warning“ on page 11

ATTENTION

Material damage due to security vulnerabilities in programs, IT networks and protocols.

Security vulnerabilities can lead to data misuse and faults and even the standstill of your IT infrastructure.

To protect your IT system, network, data communications and measurement devices:

- **Inform your network administrator and/or IT representative.**
- **Always keep the meter firmware up to date and protect the communication to the meter with an external firewall. Close unused ports.**
- **Take protective measures against viruses and cyber attacks from the Internet, e.g. through firewall solutions, security updates and virus protection programs.**
- **Eliminate security vulnerabilities and update or renew existing protection for your IT infrastructure.**

4. Structure of the device



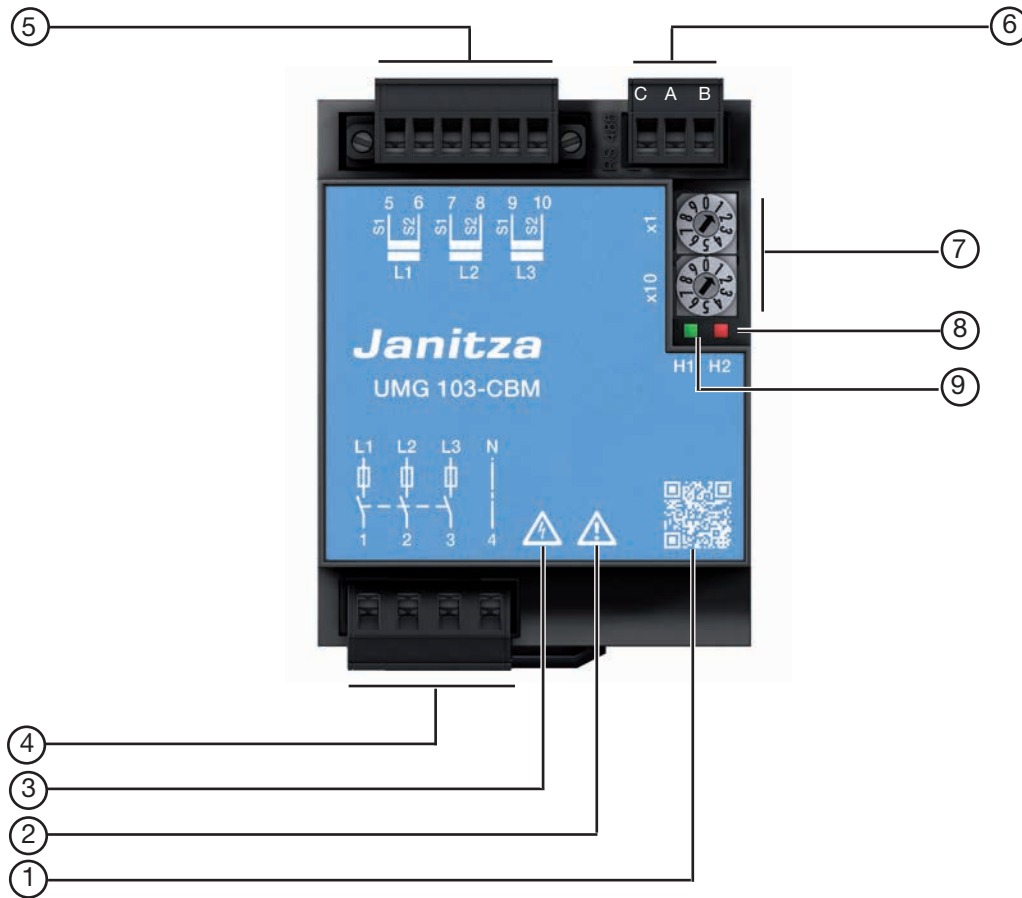



4.1 Front panel and controls



Item	Function/Designation
1	QR code to the download area of the Janitza homepage
2	“Hazard symbol” – General warning symbol. Be certain to observe the warning notices applied to the device and shown in the usage information in order to avoid possible injury or even death.
3	“Electrical hazard symbol” – General warning symbol. Be certain to observe the warning notices applied to the device and shown in the usage information in order to avoid possible injury or even death.
4	Voltage measurement inputs V_{L1} , V_{L2} , V_{L3} , V_N
5	Current measurement inputs I_{L1} , I_{L2} , I_{L3}
6	RS-485 interface
7	Coding switches for configuring the device addresses from 01 to 99
8	H2 red LED (for display patterns, see table on the following page)
9	H1 green LED (for display patterns, see table on the following page)

Tab.: Front panel - controls

4.2 LED display patterns

LEDs	Display
	The green LED is lit. The measuring and supply voltages are within the operating voltage range. The device is in operation. The LED blinks for 0.5 sec every 5 sec.
	The green LED is blinking. Data transmission (RS-485) is active.
	The LEDs blink simultaneously. The data transmission (RS-485) is faulty.
	The red LED is lit. Error in the device! Have the device checked by the manufacturer!
	The red LED is blinking. At least one current or voltage measurement input exceeds the measuring range.
	The LEDs blink alternately. Firmware checksum error. Operation is faulty. Perform a firmware update.

Tab.: LED display patterns

4.3 Identification of the device (rating plate)

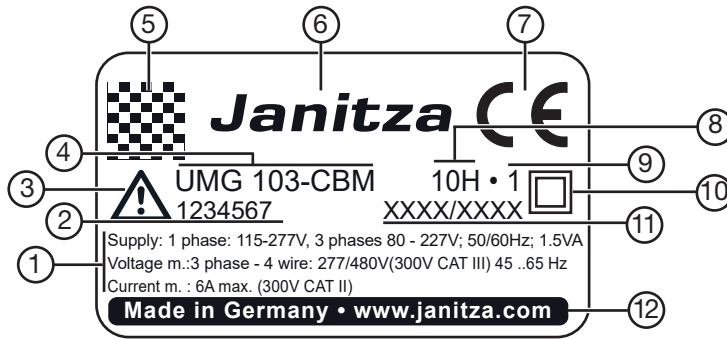

Item	Designation	Description
1	Operational data	<ul style="list-style-type: none"> • Supply voltage, AC in V • Nominal frequency in Hz • Power consumption in VA • Overvoltage category • Rated current
2	Part number	Manufacturer's part number
3	Symbol for "Danger sign"	General hazard symbol. Be certain to observe the warning notices applied to the device and shown in the documentation in order to avoid possible injury or even death.
4	Device type	Device designation
5	Data matrix code	Coded manufacturer data
6	Manufacturer's logo	Logo of the device manufacturer
7	CE conformity marking	see section „Warning“ on page 11.
8	Manufacturer-specific data	Manufacturer data
9	Hardware version	Hardware version of the device
10	Protection class	II, protective insulation
11	Type/serial number	Number for identification of the device
12	Designation of origin/web address	Country of origin and manufacturer's web address

Tab.: Rating plate

5. Mounting

5.2 Installation location

⚠ DANGER

Danger of electric shock!

Electric shocks lead to serious injuries, including death.

- Disconnect your system from the power supply before mounting and connecting the device!
- Secure it against being switched on!
- Check to be sure it is de-energized!
- Ground and short circuit!
- Cover or block off adjacent live parts!
- The installation must only be carried out by qualified personnel with electrical training!

- The device meets the operating conditions according to DIN IEC 60721-3-3 and is intended for weather-protected, stationary use.
- Mount the meter in switch cabinets or small distribution boards according to DIN 43880. The device is to be mounted on a 35-mm mounting rail to DIN EN 60715.

ATTENTION

Material damage due to improper handling or disregard of the assembly instructions!

Disregard of the installation instructions can damage or destroy your device.

- **Use suitable mounting rails according to DIN EN 60715 for mounting the meter!**
- Provide adequate air circulation in your installation environment and, as needed, cooling when the temperatures are high.

5.1 Mounting orientation

- The mounting orientation is arbitrary.
- Forced ventilation is not required

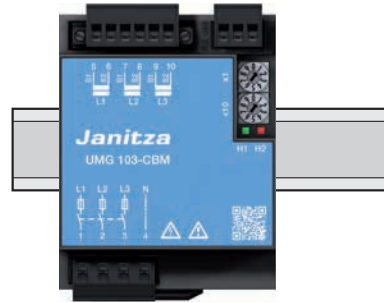
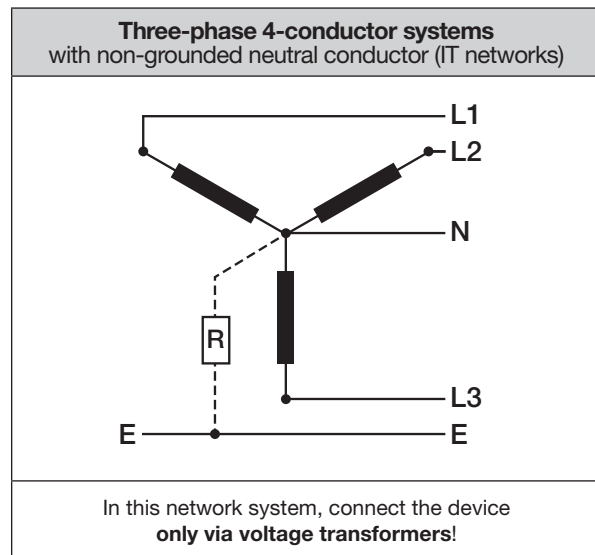
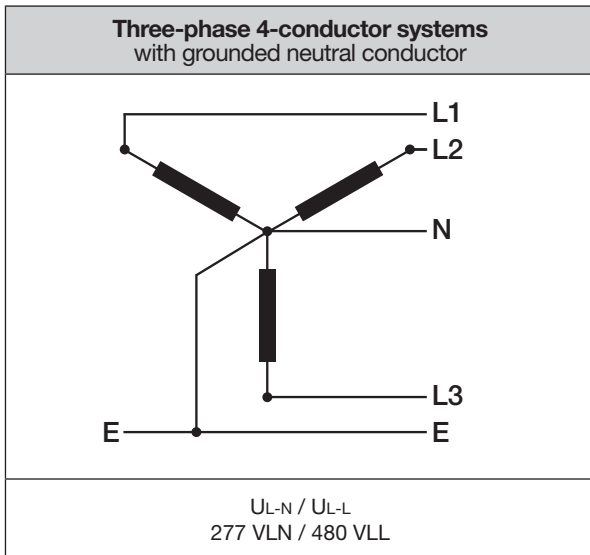

Fig. Device on mounting rail to DIN EN 60715.

6. Grid systems

Suitable grid systems and maximum rated voltages according to DIN EN 61010-1/A1:



Application areas for the meter in:

- TN and TT networks
- Residential and industrial areas



WARNING

Risk of injury due to electrical voltage!

Rated surge voltages above the permitted over-voltage category can damage the insulation in the device. This impairs the safety of the device. This can result in serious injury or death.

- **Only use the device in environments which comply with the permissible rated surge voltage.**
- **Observe the limit values specified in the user manual and on the rating plate.**

7. Installation

Use the measurement device for voltage measurement in TN and TT grid systems with the approved overvoltage category of 300V CATIII (rated surge voltage 4 kV).

⚠ WARNING

Risk of injury due to electrical voltage!
Do **not** short-circuit secondary connections of voltage transformers! This can result in serious injury or death.

- **Connect voltage transformers according to their documentation!**
- **Check your installation!**

⚠ WARNING

Disregard of the connection conditions of the transformers to Janitza measurement devices or their components can lead to injuries or even death or to material damage!

- Do not use Janitza measurement devices or components for critical switching, control or protection applications (protective relays)! It is not permitted to use measured values or measurement device outputs for critical applications!
- For Janitza measurement devices and their components use **only** “Transformers for measurement purposes” which are suitable for the energy monitoring of your system. Do **not** use “Transformers for protection purposes”!
- Observe the information, regulations and limit values in the usage information on “Transformers for measuring purposes”, specifically during testing and commissioning of the Janitza measurement device, the Janitza component and your system.

7.1 Nominal voltages

7.1.1 Three-phase four-conductor network with grounded neutral conductor

Suitable mains and nominal voltages for your meter:

U_{L-N} / U_{L-L}	
66 V / 115 V	
120 V / 208 V	
127 V / 220 V	
220 V / 380 V	
230 V / 400 V	
240 V / 415 V	
260 V / 440 V	
277 V / 480 V	Maximum nominal voltage of the network

Tab.: Nominal network voltages suitable for measuring inputs acc. to EN 60664-1:2003

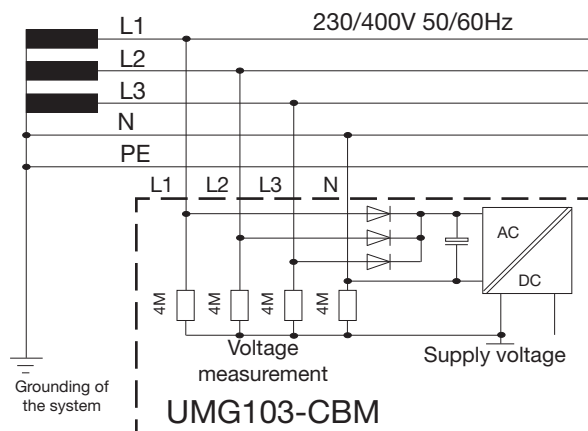

Fig. Schematic diagram, UMG103-CBM in a TN network.

7.2 Disconnect switch

When installing in a building, provide a suitable disconnect switch for the supply voltage in order to disconnect your system and thus your device from the supply of power.

- Install the disconnect switch of your system or device in such a way that it is easily accessible by the user.
- Mark the switch as an isolation device for your system or device.
- The isolation device must be UL/IEC approved.

INFORMATION

- As an alternative to the fuse and isolation device, you can use a line circuit breaker.

INFORMATION

- The voltage transformer ratios can be configured via the GridVis® software

7.3 Supply voltage

CAUTION

Material damage due to disregard of the connection instructions!

Disregard of the connection instructions can damage or destroy your device.

Therefore please abide by the following:

- **Observe the voltage and frequency specifications on the rating plate!**
- **Connect the measured voltage and supply voltage via a fuse according to the technical data!**
- **Do not tap the measured voltage and supply voltage at the voltage transformers!**
- **Provide a fuse for the neutral conductor if the neutral conductor terminal of the source is not grounded!**

WARNING

Risk of injury due to electrical voltage!

Severe bodily injury or death can result from:

- Touching bare or stripped leads that are energized.
- Device inputs that pose a hazard when touched.
- Disconnect your system from the power supply before mounting and connecting the device!
- Secure it against being switched on!
- Check to be sure it is de-energized!
- Ground and short circuit!
- Cover or block off adjacent live parts!

A measured voltage and supply voltage are required to operate the device. The type and level of the measured voltage and the supply voltage for your device can be found on the rating plate. Before applying the measured voltage and the supply voltage, make sure that the voltage and frequency match the specifications on the rating plate.

- The device obtains its supply voltage from the measured voltages L1-N, L2-N and L3-N. At least one phase must be within the nominal voltage range (see chapter „13. Technical data“ on page 54).
 - The connection of the supply voltage via an overcurrent protection device (UL/IEC approved) is made via plug-in terminals on the bottom of the device.
 - A line circuit breaker can also be used as an isolation device and a means of line protection. The line circuit breaker must be UL/IEC approved.
 - The overcurrent protection device must be adapted to the wire cross section used.
 - After connecting the supply voltage, the green LED on the front of the device lights up.
- If the green LED does not light up, check:
- The connection of your device.
 - The supply voltage.

7.4 Voltage measurement

The device has 3 voltage measurement inputs (VL1, VL2, VL3) and is suitable for different connection variants.

WARNING

Risk of injury or damage to the device due to electrical voltage and improper connection!

Failure to comply with the connection conditions for the voltage measurement inputs can result in damage to the device or serious injury, including death.

Therefore, please observe the following:

- **Switch off your installation before commencing work! Secure it against being switched on! Check to be sure it is de-energized! Ground and short circuit! Cover or block off adjacent live parts!**
- **Do not apply a DC voltage**
 - to the voltage measurement inputs.
 - Equip the voltage measurement inputs with a suitable, marked fuse and isolation device (alternatively: line circuit breaker) located nearby.
 - The voltage measurement inputs are dangerous to touch.
- **Connect voltages that exceed the permissible nominal network voltages via a voltage transformer.**
- **Measured voltages and currents must originate from the same network.**

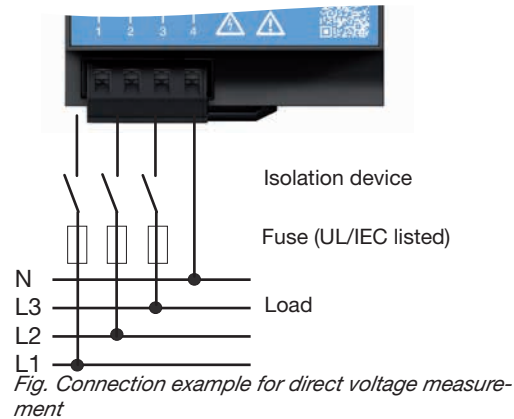

INFORMATION

As an alternative to the fuse and isolation device, you can use a line circuit breaker.

INFORMATION

The device's suitability for measurements in medium and high voltage networks is limited because it obtains the supply voltage from the measured voltage and loads the voltage transformer with a non-linear current.

ATTENTION

Voltages that exceed the permissible nominal network voltages must be connected via a voltage transformer.

7.4.1 Overvoltage

The voltage measurement inputs are designed for measurements in low-voltage networks in which nominal voltages occur as described in the chapter „Warning“ on page 11,13. Technical data“ on page 54.

Information on the rated surge voltages and overvoltage categories can also be found in the technical data.

7.4.2 Frequency

The device:

- Requires the mains frequency for the measurement and calculation of measured values.
- Is suitable for measurement in networks in which the fundamental oscillation of the voltage is in the range from 45 Hz to 65 Hz.

The mains frequency is determined from the measured voltage of phase L1. The sampling frequency of the voltage and current measurement inputs results from the mains frequency.

When measuring with strongly distorted voltages, the frequency of the voltage fundamental oscillation can no longer be determined exactly. This means that for strongly distorted measured voltages, the corresponding mains frequency should have a fixed specification. Voltage distortions occur, for example, during measurements on consumers that are operated with phase-angle control. Distortions of the current do not influence the frequency determination.

7.4.3 Connection variants for voltage measurement

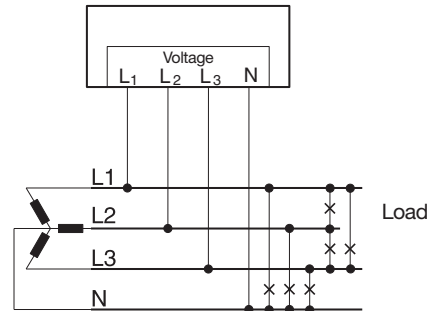

Fig.: Voltage measurement in three-phase 4-conductor system

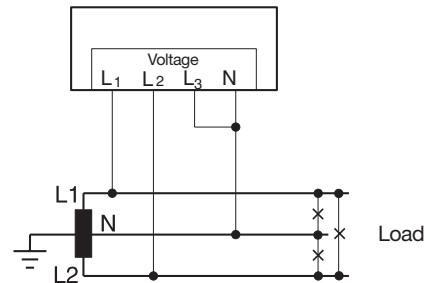

Fig.: Voltage measurement in a single-phase 3-conductor system

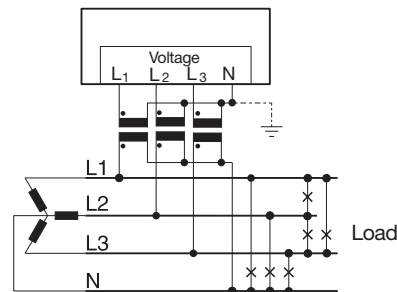

Fig.: Voltage measurement in a three-phase 4-conductor system via voltage transformer

ⓘ INFORMATION

The device only allows the setting of **one voltage transformer ratio for all phases!** The **voltage transformer ratios** can be configured conveniently via

- the GridVis® software.

For information on voltage transformer configuration, see the chapter „9.1 Current and voltage transformers“ on page 38.

7.5 Current measurement

The device:

- Measures current exclusively via current transformers.
- Does not measure DC currents.
- Allows the connection of current transformers with a transformer ratio of .. /1 A and .. /5 A for current measurement inputs.
- Is factory-set to a current transformer ratio of 5/5 A and must be adapted to the current transformers employed using the GridVis® software if necessary.
- Each current measurement input can be loaded with 6 A continuously or with 60 A for 1 second.

The current transformers require a basic insulation according to IEC 61010-1:2010 for the nominal voltage of the circuit.

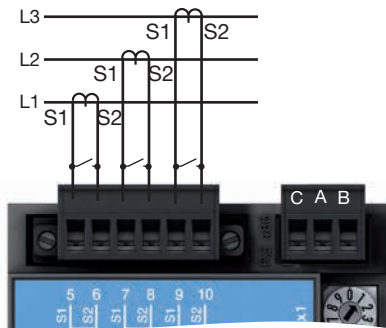

Fig. Connection example, "Current measurement via current transformer".

⚠ WARNING

Risk of injury due to high currents and high electrical voltages!

Severe bodily injury or death can result from:

- Touching bare or stripped leads that are energized.
- Dangerous live current measurement inputs of the device and at the current transformers.

Therefore, please note for your system:

- **Disconnect the supply of power before starting work!**
- **Secure it against being switched on!**
- **Check to be sure it is de-energized!**
- **Ground and short circuit! Use the ground connection points with the ground symbol for grounding!**
- **Cover or block off adjacent live parts!**

⚠ WARNING

Risk of injury due to electrical voltage at current transformers!

Current transformers which are operated exposed on the secondary side can carry hazardous live high voltage peaks which can lead to serious bodily injury or death.

Therefore please abide by the following:

- **Switch off your installation before commencing work! Check to be sure it is de-energized!**
- **Avoid exposed operation of the current transformers.**
- **Short circuit unloaded current transformers.**
- **Before interrupting the supply of power, it is essential to short the secondary connections of the current transformers.**
- **If there is a test switch which automatically short-circuits the secondary current transformer lines, it is sufficient to set it to the "Test" position, provided that the short-circuiters have been checked beforehand.**
- **Only use current transformers with basic insulation according to IEC 61010-1:2010.**
- **Fix the attached screw terminal to the device with the two screws.**
- **Even current transformers rated as safe for exposed operation are dangerous to touch if they are operated exposed.**
- **Observe the documentation for the current transformers!**

⚠ WARNING

Risk of injury or damage to the device due to electrical voltage and improper connection!
High measuring currents can cause temperatures of up to 80 °C (176 °F) at the connections.
Use wiring designed for an operating temperature of up to 80 °C (176 °F)!

ℹ INFORMATION

The device only allows the setting of **one current transformer ratio for all phases!**
You can configure **current transformer ratios** conveniently via the GridVis® software.

⚠ ATTENTION

Material damage due to disregard of the connection instructions during current measurement.

Failure to comply with the connection requirements of your device can result in the permissible current measurement range being exceeded. This can lead to damage or destruction of your device or your system and thus to material damage!

- **Use current transformers for current measurement! The device only allows current measurement via current transformers!**
- **Observe the connection conditions for the current measurement inputs of your device and the current transformers!**

7.5.1 Connection variants for current measurement

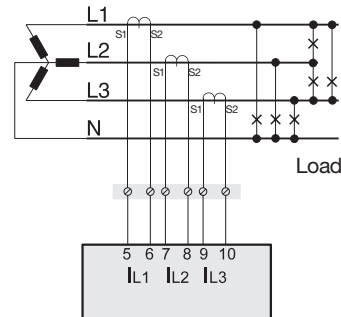

Fig.: Current measurement via current transformer in a three-phase 4-conductor system

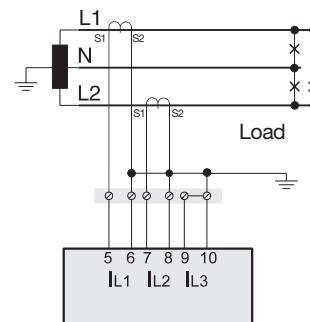

Fig.: Current measurement in a single-phase 3-conductor system

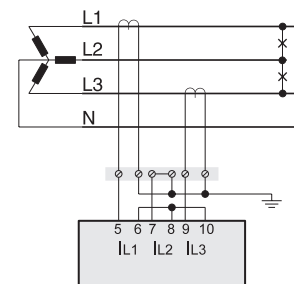

Fig.: Current measurement via 2 current transformers in a three-phase 4-conductor system

7.5.2 Ammeter

If you want to measure the current not only with the UMG, but also with an ammeter, connect the ammeter to the UMG in series.

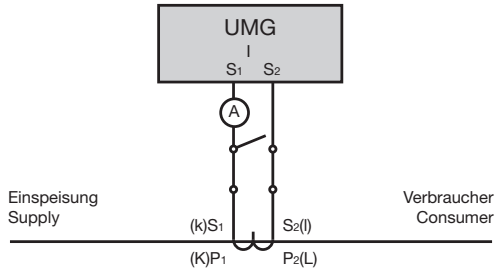

Fig. Circuit diagram with additional ammeter connected in series

i INFORMATION

The red LED blinks if the measuring range is exceeded, see chapter „4.2 LED display patterns“ on page 21

i INFORMATION

The device only allows the setting of **one current transformer ratio for all phases!**
 You can configure **current transformer ratios** conveniently via
 · The GridVis® software.

7.5.3 Current direction

You can correct the current direction for each phase individually via the serial interfaces provided. This means that in the case of incorrect connection, no subsequent reconnection of the current transformers is necessary.

7.5.4 Summation current measurement

For a summation current measurement via two current transformers, first set their total ratio in the device. This is done in the GridVis software

Example:

The current is measured via two current transformers. Both current transformers have a ratio of 1000/5 A. The summation measurement is carried out with a summation current transformer of 5+5/5 A.

The device must then be adjusted as follows:

Primary current: 1000 A + 1000 A = 2000 A
 Secondary current: 5 A

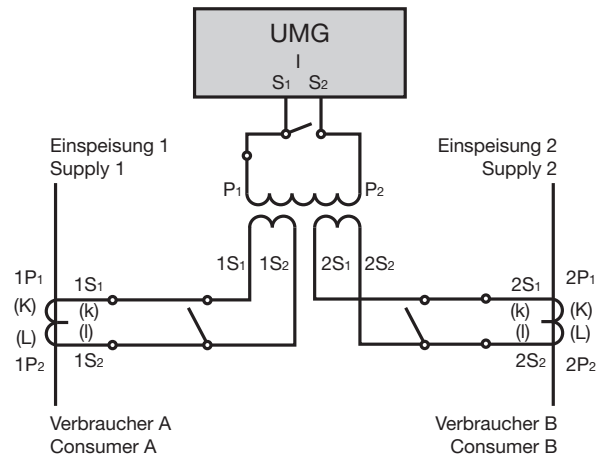

8. Connection and PC connections

8.1 Connection variants

When connecting the device to a PC, there are several possibilities:

1. Connection via an interface converter:

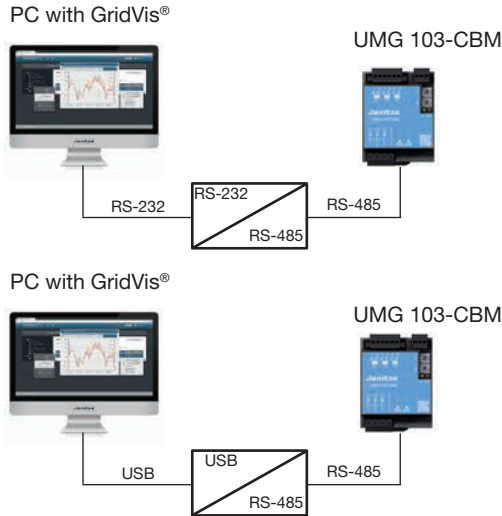

2. Use of the UMG 103-CBM (slave) via a UMG (master) with gateway functionality (e.g. UMG 604-PRO):

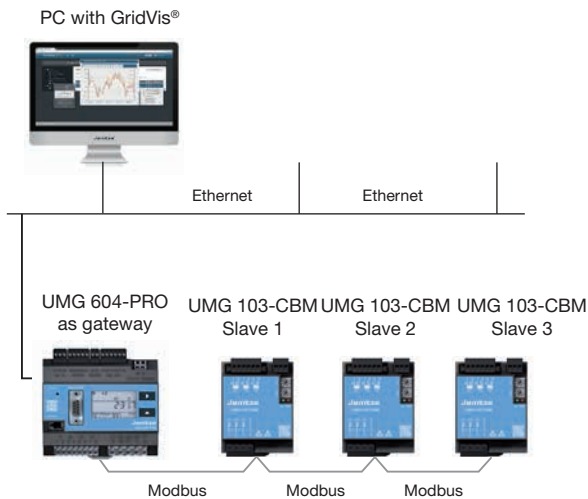

ATTENTION

Material damage due to security vulnerabilities in programs, IT networks and protocols. Security vulnerabilities can lead to data misuse and faults and even the standstill of your IT infrastructure.

To protect your IT system, network, data communications and measurement devices:

- Inform your network administrator and/or IT representative.
- Always keep the meter firmware up to date and protect the communication to the meter with an external firewall. Close unused ports.
- Take protective measures against viruses and cyber attacks from the Internet, e.g. through firewall solutions, security updates and virus protection programs.
- Eliminate security vulnerabilities and update or renew existing protection for your IT infrastructure.

ATTENTION

Material damage due to incorrect network settings.

Incorrect network settings can cause faults in the IT network!

Consult your network administrator for the correct network settings for your device.

8.2 RS-485 interface

The RS-485 interface of this device is designed as a 3-pole plug contact and communicates using the Modbus RTU protocol.

Device address 1 and the baud rate are factory set to "automatic detection".

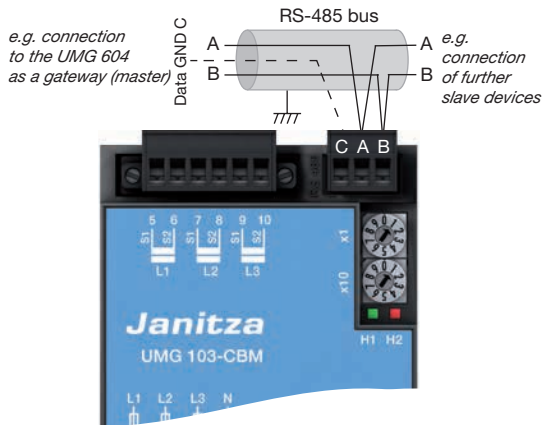

Fig. RS-485 interface, 3-pole plug contact

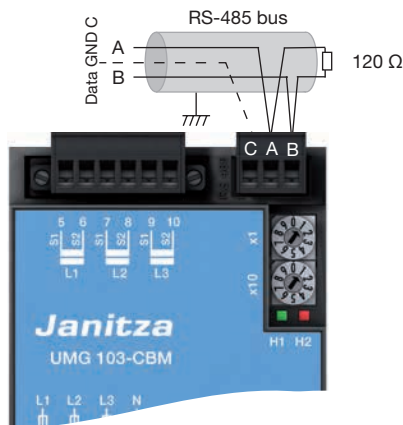

Fig. RS-485 interface, 3-pole plug contact with termination resistor (part no. 52.00.008)

i INFORMATION

CAT cables are not suitable for the bus wiring. Use the recommended cable type for this purpose.

⚠ WARNING

Transmission error and risk of injury due to electrical fault!

Atmospheric discharge can cause transmission errors and hazardous voltages on the device.

Therefore please abide by the following:

- **Connect the shielding to functional earth (PE) at least once.**
- **In the case of larger sources of interference, frequency converters in the switchboard cabinet, connect the shielding to functional earth (PE) as close as possible to the device.**
- **Observe the maximum cable length of 1200 m (3960 ft.) at a baud rate of 38.4 k.**
- **Use shielded cables.**
- **Route interface cables spatially separated or additionally insulated from mains voltage-carrying system components.**

8.3 Shielding

Provide a twisted and shielded cable for connections via the interfaces and observe the following points for shielding:

- Ground the shields of all cables leading into the cabinet at the cabinet entrance.
- Connect the shield to a noiseless ground and ensure a large surface area with good conductivity.
- Do **NOT** connect the shield to terminal C (GND)
- Mechanically restrain the cables before the grounding clamp to prevent damage from cable movement.
- Use suitable cable glands, for example PG glands, to lead the cable into the switchboard cabinet.

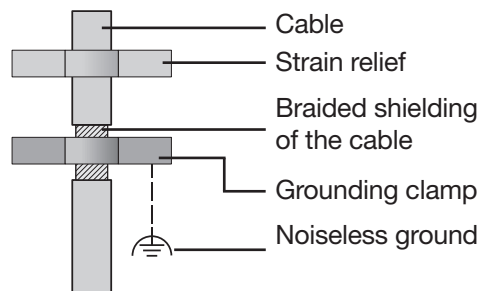

Fig. Shielding design for cabinet entry.

Recommended cable type:

- **Unitronic Li2YCY(TP) 2x2x0.22 (Lapp cable)**

8.4 Bus structure

In a bus structure:

- Connect all devices in line according to the master-slave principle.
- Each device has its own address.
- One segment contains up to 32 nodes/devices.
At the beginning and end of a segment, the cable must be terminated with resistors (bus termination, 120 ohms, 1/4 W)!
- With more than 32 participants, use repeaters (line amplifiers) to connect segments!
- Devices with bus termination switched on must be powered.
- It is recommended that the master be placed at the end of a segment. If the master is replaced with the bus termination switched on, the bus is out of operation.
- The bus can become unstable if a slave with bus termination switched on is replaced or is de-energized.
- Devices that are not involved in the bus termination can be replaced without the bus becoming unstable.



8.5 Termination resistors

At the beginning and end of a segment, the cable is to be terminated with resistors (120 Ω, 1/4 W).

i INFORMATION

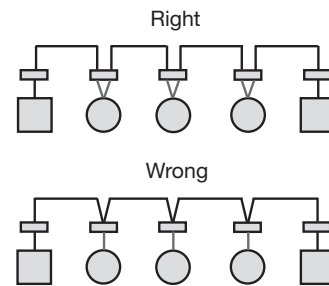
The device does not contain an integrated termination resistor!



	Terminal strip in the switchboard cabinet.
	Device with RS-485 interface. (Without termination resistor)
	Device with RS-485 interface. (With termination resistor on the device)

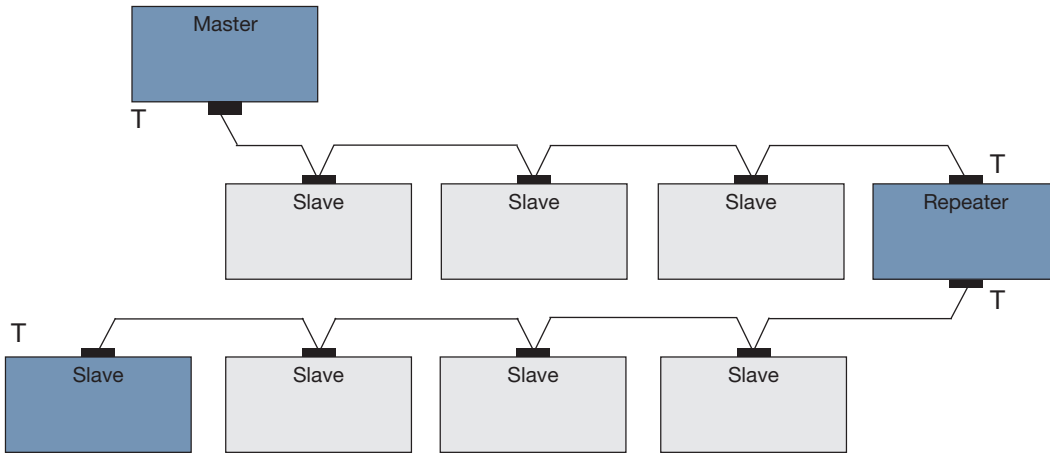

Fig. Bus structure

 Power supply necessary

T Bus terminator on

Master - e.g. UMG 604-PRO

Slave - e.g. UMG 103-CBM

9. Configuration

The supply voltage required for operation is obtained from the measured voltages L1-N, L2-N and L3-N. At least one phase (L-N) must be within the nominal voltage range (see chapter „7.2 Disconnect switch“ on page 27).

9.1 Current and voltage transformers

i INFORMATION

Before configuring the current and voltage transformer ratios, be certain to connect the transformers in compliance with the specifications on the device rating plate and the technical data!

- A current transformer of 5/5 A is set at the factory.
- The pre-programmed voltage transformer ratio must only be changed if voltage transformers are connected.
- If the current measurement is made via two current transformers, the total ratio of the current transformers must be programmed in the device. Example: The current is measured via two current transformers. Both current transformers have a ratio of 1000/5 A. The summation measurement is carried out with a summation current transformer of 5+5/5 A. Primary current: 1000A + 1000A = 2000A Secondary current: 5A The device must be adjusted as follows: address 000 = 2000 (primary current) address 001 = 0005 (secondary current)

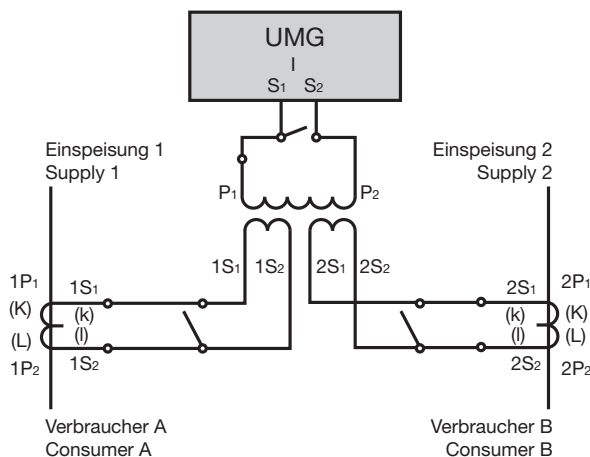

i INFORMATION

Devices with automatic frequency detection set take about 5 seconds to determine the mains frequency. During this time, the measured values **do not** maintain the guaranteed measurement uncertainty.

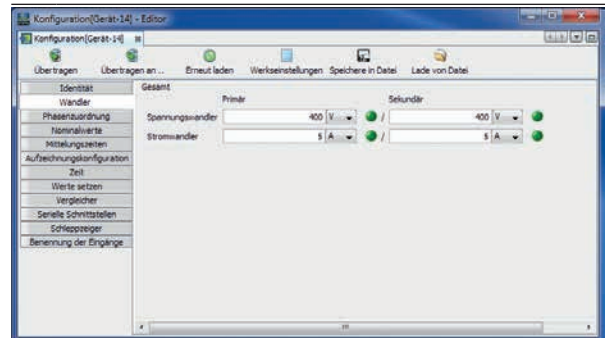

Fig. Display for configuring the current and voltage transformers in the GridVis software.









i INFORMATION

- The items that can be configured using the GridVis® software include the current and voltage transformer ratios.

9.2 Device addresses

If several devices are connected to each other via the RS-485 interface, a master device can only distinguish these devices on the basis of their device address. Within a network, each device must therefore have a different device address.

The device address can be configured via the rotary selector switches available on the UMG 103-CBM. Addresses in the range of 1 to 99 can be set here.

X10	X1	Function
		The device address 00 is reserved and must not be assigned for operation with Modbus communication.
		The device address 99 can be obtained by setting the rotary selector switch X10 to 9 and X1 to 9. No higher value device address can be set for the UMG 103-CBM.
		Example: Setting the device address to 13
		Standard factory setting: Device address 1

Tab. Setting device addresses via coding switches

i INFORMATION

In the RS-485 bus structure, assign the slave devices (UMG 103-CBM) via the coding switches:

- Different device addresses.
- Device addresses that are different than the master device (e.g. UMG 604-PRO).

The UMG 103-CBM recognizes the transmission rate (baud rate) automatically.

9.3 RS-485

The device sends and receives data via the RS-485 interface. For example, the device receives data from the parameter and measured value list via a MODBUS RTU protocol with CRC check.

Modbus functions (slave)

03 Read Holding Registers
 04 Read Input Registers
 06 Preset Single Register
 16 (10Hex) Preset Multiple Registers
 23 (17Hex) Read/Write 4X Registers

The order of the bytes is high before low byte (Motorola format).

Transmission parameters

Data bits: 8
 Parity: odd
 even
 none (1 stop bit)

Stop bits: 1 / 2

Number formats

short 16 bit ($-2^{15} .. 2^{15} - 1$)
 Float 32 bit (IEEE 754)

i INFORMATION

- Broadcast (address 0) is not supported by the device.
- The telegram length must not exceed 256 bytes

! CAUTION

Material damage due to incorrect network settings.

Incorrect network settings can cause faults in the IT network.

Consult your network administrator for the correct network settings for your device.

10. Commissioning

i INFORMATION

Before commissioning, delete any possible production-related contents of the energy meters, minimum and maximum values and records.

See section „10.8 Energy meters - clearing minimum and maximum values“ on page 45

! WARNING

Material damage due to disregard of the connection instructions!

Voltages and currents outside the permissible measuring range can destroy the device.

Comply with the measuring range specifications from the technical data.

10.1 Measured voltage / supply voltage

i INFORMATION

In networks with nominal voltages that exceed the specified nominal voltages of 300 VAC, connect the voltage measurement inputs via voltage transformers.

Connecting measured voltage / supply voltage:

1. Connect the measured voltage to the terminals provided for this purpose on the device (see section „7.3 Supply voltage“ on page 27 and section „7.4 Voltage measurement“ on page 28).
2. After connecting the measured voltage, check the measured values measured by the device (if necessary, via the GridVis software) for the voltages L-N and L-L.
Take into account any voltage transformer factors that may be set!

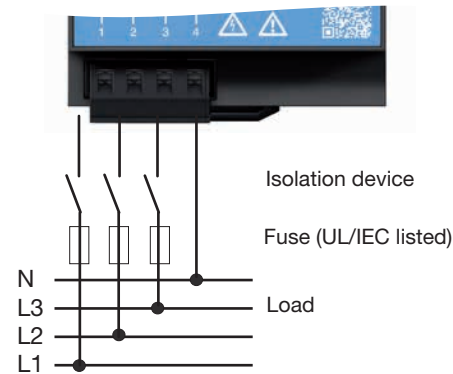

! WARNING

Risk of injury due to electrical voltage!

If the device is exposed to surge voltages above the permissible overvoltage category, safety-relevant areas of insulation in the device can be damaged. This means that the safety of the product can no longer be guaranteed.

Only use the device in environments in which the permissible overvoltage category is not exceeded.

10.2 Measured current

The device:

- Is designed for the connection of current transformers with secondary currents of $\dots/1$ A and $\dots/5$ A.
- Does not measure DC currents.

The factory-set current transformer ratio is 5/5 A and must be adapted to the current transformers used as needed. The current transformers require a basic insulation according to IEC 61010-1:2010 for the nominal voltage of the circuit.

1. Short-circuit all current transformer outputs except one.
2. Compare the current measured by the device (if necessary via the GridVis software) with the applied input current.
 - The currents must match after taking the current transformer ratio into account.
 - At the short-circuited current measurement inputs, the value measured must be approx. 0 amperes.

CAUTION

Risk of injury or damage to the meter due to high measurement currents at the connections of the current transformers!

High measurement currents can cause temperatures of up to 80 °C (176 °F) on the connections of the current transformers

- **Use wiring that is designed for an operating temperature of at least 80 °C (176 °F)!**
- **The current transformers can be hot even after the power supply has been switched off. Allow the connections of the current transformers and the connecting cables to cool down before touching them!**

10.3 Direction of rotary field

In the GridVis software, check the direction of the voltage rotating field.

- Usually it is a “right” rotating field.

10.3.1 Fundamentals on the phasor diagram

The phasor diagram graphically describes the phase shift or phase angle between the voltage and the current. The phasors rotate at a constant angular speed – proportional to the frequency of the voltage and current – around an origin. The phasor diagram thus shows the momentary state of the variables in an AC circuit.

Representation of ohmic resistance:

- Voltage and current are in phase.

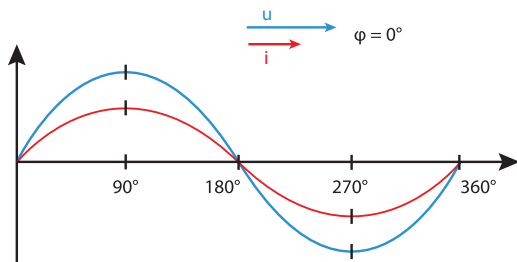

Representation of inductance:

- The voltage is ahead of the current.
- The phase shift for an “ideal coil” is 90° .

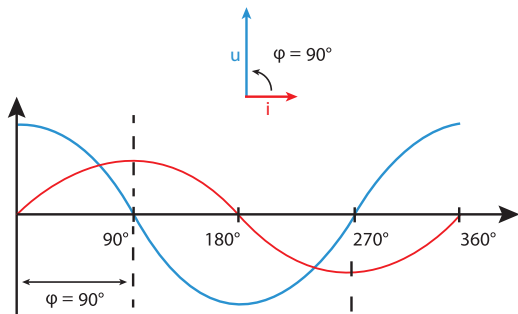

Representation of capacitance:

- The current is ahead of the voltage.
- The phase shift of an “ideal capacitor” is 90° .

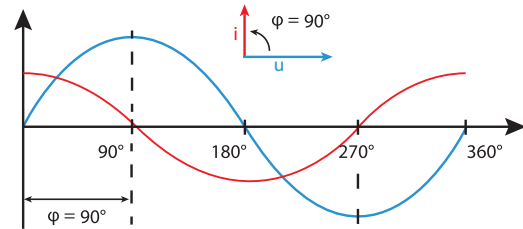

With a combination of the states, the phase angle “current to voltage” can assume values between -90° and $+90^\circ$.

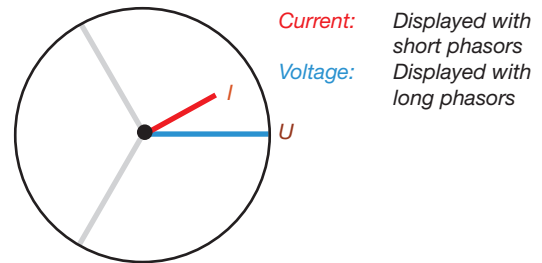

Example phasor diagram (3-phase)

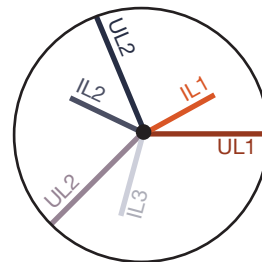

Current and voltage are shifted against each other. The current is ahead the voltage, i.e. the network is capacitively loaded.

10.3.2 Checking of voltage and current inputs by means of phasor diagram

The phasor diagram can be used to check incorrect connections at the voltage and current inputs.

Example 1

Primarily ohmic load.

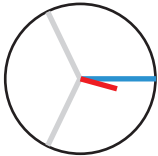

Voltage and current have only a small deviation in the phase position.

- The current measurement input is assigned to the correct voltage measurement input

Example 2

Primarily ohmic load.

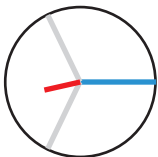

Voltage and current have a deviation of about 180° in the phase position.

- The measured current input is assigned to the correct voltage measurement input.
- In the current measurement under consideration, the connections k and l are reversed or there is a feedback into the supply network.

10.4 Control of the power measurement

Short circuit all current transformer outputs except one and check the power values displayed in the GridVis software.

- The device must only measure power in the phase with the current transformer input that is not short-circuited.
- If this is not the case, check the connection of the measured voltage and measured current.

If the amount of active power is correct, but the sign of the active power is negative, this can have two causes:

1. The connections S1(k) and S2(l) on the current transformer are reversed.
2. Active energy is returned to the grid.

10.5 Checking measurement

Correctly connected voltage and current measurement inputs result in correctly calculated individual and summation power readings displayed in the GridVis software.

10.6 Checking individual power

If a current transformer is assigned to the wrong phase, the corresponding power is measured and displayed incorrectly.

The phase conductor and current transformer are correctly assigned on the device if there is no voltage between the phase conductor and the associated current transformer (primary).

To ensure that a phase conductor at the voltage measurement input is assigned to the correct current transformer for the power measurement, the respective current transformer can be short-circuited on the secondary side. The apparent power displayed in the GridVis software must then be zero for this phase.

If the apparent power is measured correctly, but the active power has a negative ("-") sign, then the current transformer terminals are reversed or power is being delivered to the electric utility.

10.7 Checking summation power

If all voltages, currents and powers for the respective phase conductors are correctly measured, the summation powers measured by the device are also correct. To confirm, compare the summation powers displayed in the GridVis software with the work of the active and reactive power meters located in the feeder.

10.8 Energy meters - clearing minimum and maximum values

- Active, apparent, reactive energy meters can only be cleared together. To delete the content, "001" must be written to address 9.
- To delete the minimum and maximum values, write "001" to address 8.

10.9 Overrange

Overrange values are displayed in the GridVis software as long as they are present. Alarms can be acknowledged with button 5 *Alarms*. The measuring range is exceeded if at least one of the voltage or current measurement inputs lies outside its specified measuring range.

Limit values for overrange (200 ms effective values):

$$\begin{array}{lcl} I & = & 6 A_{rms} \\ U_{L-N} & = & 600 V_{rms} \end{array}$$

10.10 "Drag indicator" function

The "drag indicator" function describes the three highest average values of value types over a defined period (time base).

- The average values determined can be called up via the GridVis® software and via a parameter with a time stamp.
- The period duration (time base), synchronization and capture time can be set in the Grid-Vis® software or by setting the corresponding parameters.
- The average value is calculated from the measured values of the following value types:
 - Current L1
 - Current L2
 - Current L3
 - Active power L1
 - Active power L2
 - Active power L3
 - Active power sum (L1...L3)
 - Apparent power L1
 - Apparent power L2
 - Apparent power L3
 - Apparent power sum (L1...L3)

Period duration (time base):

Individually configurable period duration in seconds for the calculation of the average values over this period (duration of measured value recording). If internal synchronization is selected, the average values are recalculated after the set period of time has elapsed.

Synchronization mode:

A synchronization determines a start time for the calculation periods of the average values. You can optionally start a synchronization via

- the internal clock (*internal synchronization*),
- the setting of a parameter (via Modbus).

Capture time:

The individually configurable *Capture time* describes a time window in which an incoming pulse synchronizes the point in time. If the device receives a pulse outside the capture time, the calculated average values are deleted and the time is reset.

Note: The setting for the capture time – e.g. in the GridVis® software – describes half the time window of the total capture time!

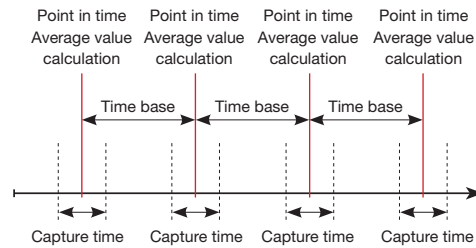

Fig.: Principle of synchronization

10.11 Internal synchronization

The average values are calculated after the configurable period of time (time base) has expired. The internal synchronization takes place at the full minute if this is a multiple of the time base.

Time base [min]	Sync 1 (time)	Sync 2 (time)	Sync 3 (time)	Sync 4 (time)
2	09:00:00	09:02:00	09:04:00	09:06:00
5	09:00:00	09:05:00	09:10:00	09:15:00
15	09:00:00	09:15:00	09:30:00	09:45:00

Tab.: Examples of internal synchronization with different time bases

i INFORMATION

For an internal synchronization, the option Synchronization by Modbus must be deactivated!

10.12 External synchronization

An external synchronization for the calculation of the 3 highest average values is performed:

- via a Modbus command.

External synchronization scenarios:

"No command despite setting"

If there is no synchronization via a Modbus command, the measured values are stored as with an internal synchronization - but not only at each full minute!

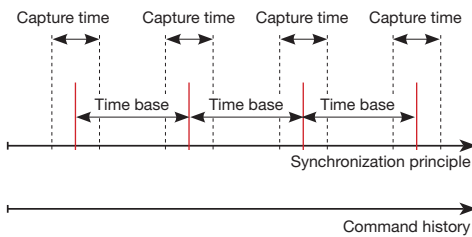

Fig.: Principle of synchronization with "No command despite setting"

Example	Maximum value	Value	Time stamp
Effective current L1	Drag indicator 1	3.51 A	09:13:07
Effective current L1	Drag indicator 2	2.52 A	09:08:07
Effective current L1	Drag indicator 3	1.52 A	09:03:07

Tab.: Example of drag indicator storage with a time stamp (with set time base of 5 min)

"One command"

If the device receives a one-time Modbus command for synchronization outside the capture time, the measured values accumulated up to that point are reset for the calculation of the average value and the time. The time is redefined as a relative zero point and a new calculation is performed!

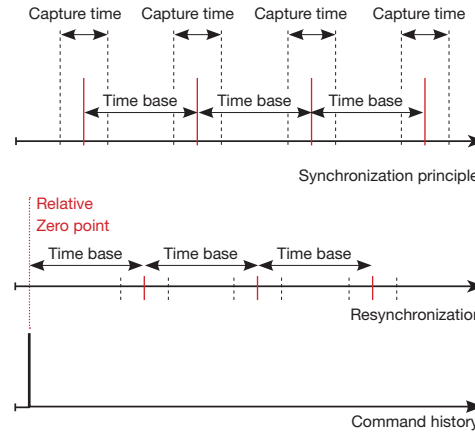

Fig.: Principle of synchronization outside the capture time"

Example	Maximum value	Value	Time stamp
Active power L1	Drag indicator Consumption 1	396.73 W	09:18:47
Active power L1	Drag indicator Consumption 2	207.34 W	09:13:47
Active power L1	Drag indicator Consumption 3	80.59 W	09:08:47

Tab.: Example of drag indicator storage with a time stamp (with set time base of 5 min)

The power increases with time. The command (09:06:47) outside the capture time sets the values back to 0. A new summation of the intermediate values begins from this point on. As no further Modbus command arrives, the calculation of the average value is done according to the set time (time base).

"Periodic commands"

If the device receives periodic Modbus commands for synchronization, there are different scenarios.

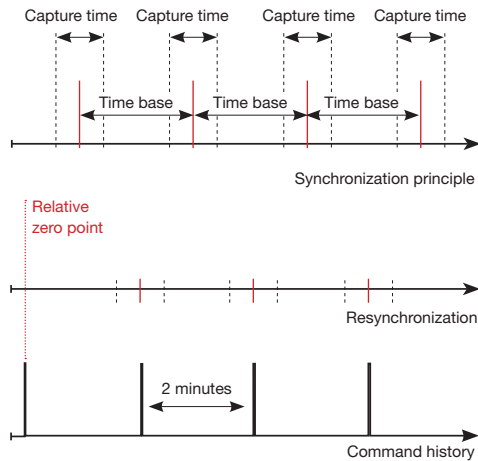
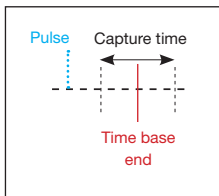

Fig.: Principle of synchronization with "Periodic commands"

Scenario "Command outside the capture time":

- Summed intermediate values are set to 0
- The time is set to 0 (new relative zero point)
- There is no value calculation



Scenario "Command according to time base, but within the capture time"

- Summed intermediate values are set to 0
- The time is set to 0 (new relative zero point)
- There is no value calculation

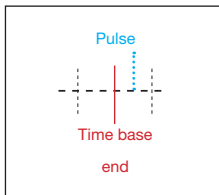

Scenario "Command before time base within the capture time"

- Perform value calculation now
- The time is set to 0 (new relative zero point)
- Delete summed intermediate values

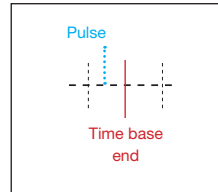

Information

With periodic synchronization, the time is synchronized with each command!

Information

The GridVis® software enables user-friendly configuration of the drag indicator functionality.

Modbus address	Function	Setting range
820	Set trigger flag for drag indicator synchronization	0 ... 1
821	Time base in seconds	60 .. 65535
822	Enable flag of the Modbus trigger	0 .. 1
823	Capture time in seconds	0 .. 254

10.13 Recording the measured values

The standard setting of the measurement device includes 2 recording profiles that you can adapt or expand in the GridVis® software.

- The smallest time base for recordings is 1 minute.
- A maximum of 4 recordings with 29 measured values each is possible.
If minimum and maximum values are defined as well, the number is reduced to 19 or 14 values, respectively.
- Within the recording configuration, measured values are defined via a time base according to the types *Average value*, *Sample*, *Maximum* or *Minimum*.
 - *Average value* type: Arithmetic mean value of the measured values over a defined period of time.
 - *Maximum* and *Minimum* type: Maximum or minimum values of a specified time period.
 - *Sample* type: Measured value at the end of the specified time period.

INFORMATION

A recording of work values is only possible with the type *Sample*!

Recording 1:

The following measured values are recorded with a time base of 15 minutes:

- Effective voltage L1
- Effective voltage L2
- Effective voltage L3
- Effective current L1
- Effective current L2
- Effective current L3
- Effective current, sum L1..L3
- Active power L1
- Active power L2
- Active power L3
- Active power, sum L1..L3
- Apparent power L1
- Apparent power L2
- Apparent power L3
- Apparent power, sum L1..L3
- $\cos \phi(\text{math.})$ L1
- $\cos \phi(\text{math.})$ L2
- $\cos \phi(\text{math.})$ L3
- $\cos \phi(\text{math.})$ Sum L1..L3
- Reactive power fundamental oscillation L1
- Reactive power fundamental oscillation L2
- Reactive power fundamental oscillation L3
- Reactive power fundamental oscillation sum L1..L3

Recording 2:

On a time base of 1 hour, the measurement device records the following measured values:

- Applied active energy L1
- Applied active energy L2
- Applied active energy L3
- Applied active energy, sum L1..L3
- Inductive reactive energy L1
- Inductive reactive energy L2
- Inductive reactive energy L3
- Inductive reactive energy, sum L1..L3

10.14 Comparator

Two comparator groups (comparator 1 and 2) each with 3 comparators (A - C) are available for monitoring limit values.

The results of comparators A to C can be linked with "AND" or "OR".

The comparators can be configured exclusively via the GridVis® software in the "Comparator" configuration area.

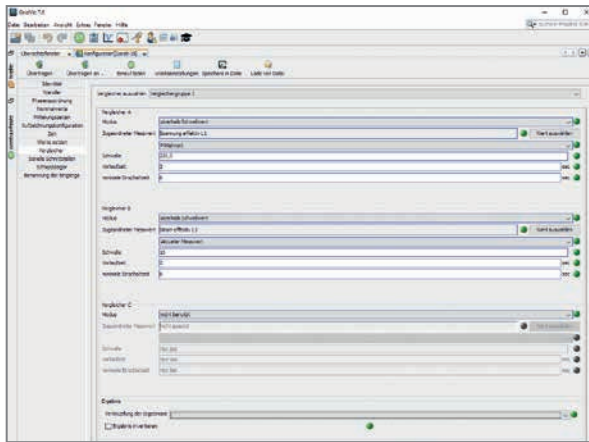
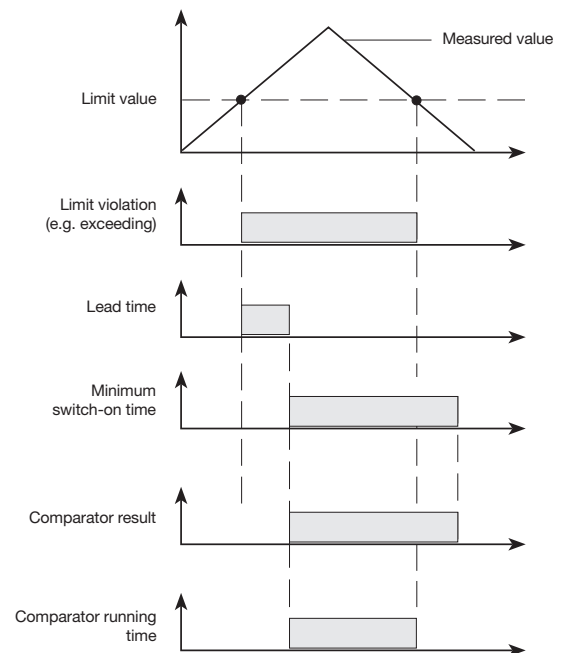

Fig. Configuration of the comparators in the GridVis® software

Comparator with limit violation set

- The set limit value is compared with the measured value.
- If there is a limit violation for at least the duration of the lead time, the comparator result is changed.
- The result is retained at least for the duration of the minimum initialization time and at most for the duration of the limit violation. If there is no longer a limit violation and the minimum initialization time has expired, the result is reset.



You can read the result of the comparators via the GridVis software. The corresponding Modbus addresses can be found in the Modbus address list at www.janitza.com

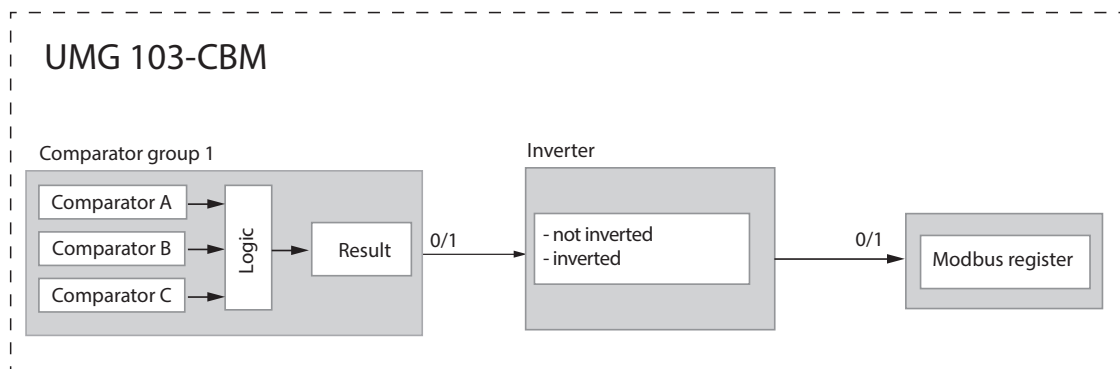

Fig. "Comparator" block diagram

11. Service and maintenance

Prior to outbound delivery, the device is subjected to various safety tests and is marked with a seal. If a device is opened, the safety tests must be repeated. A warranty is only assumed for unopened devices.

11.1 Repair and calibration

Repair and calibration of the device must only be carried out by the manufacturer or an accredited laboratory! The manufacturer recommends calibrating the device every 5 years!



WARNING

Warning of unauthorized tampering or improper use of the device.

Opening, dismantling or unauthorized manipulation of the device which goes beyond the mechanical, electrical or other operating limits indicated can lead to material damage or injury, up to and including death.

- **Only electrically qualified personnel are permitted to work on the devices and their components, assemblies, systems and current circuits!**
- **Always use your device or component only in the manner described in the associated documentation.**
- **In the event of visible damage, or for the purpose of repair and calibration, return the device to the manufacturer!**

11.2 Front panel foil

Please note the following for the care and cleaning of the front panel foil and the device:

INFORMATION

Material damage due to improper care and cleaning of the device.

The use of water or other solvents, such as denatured alcohol, acids, acidic agents for the front foil can damage or destroy the device during cleaning. Water can, for example, penetrate into the device housing and destroy the device.

- **Clean the device and the front panel foil with a soft cloth.**
- **Use a cloth moistened with clear water for heavy soiling.**
- **Clean the front foil, for example to remove fingerprints, with a special LCD cleaner and a lint-free cloth.**
- **Do not use acids or acidic agents to clean the devices.**

11.3 Service

For questions not answered or described in this manual, please contact the manufacturer. Please be certain to have the following information ready to answer any questions:

- Device designation (see rating plate)
- Serial number (see rating plate)
- Software release (see system display)
- Measured voltage and supply voltage
- An exact error description.

11.4 Battery

The internal clock is powered by the supply voltage.

If the supply voltage fails, the clock is supplied by the battery. The clock provides date and time information for records, min and max values and events, for example.

The life expectancy of the battery is at least 5 years at a storage temperature of +45° C. The typical life expectancy of the battery is 8 to 10 years.

The battery (type BR 1632, 3 V) is soldered in. To replace the battery, the device must be sent to the manufacturer.

11.5 Device adjustment

The manufacturer adjusts the devices before delivery. No readjustment is required when the environmental conditions are complied with.

11.6 Firmware update

For a firmware update, connect your device to a computer and obtain access via the **GridVis**® software:

- Open the Firmware Update Wizard by clicking on “Update Device” in the “Extras” menu.
- Select your update file and perform the update.

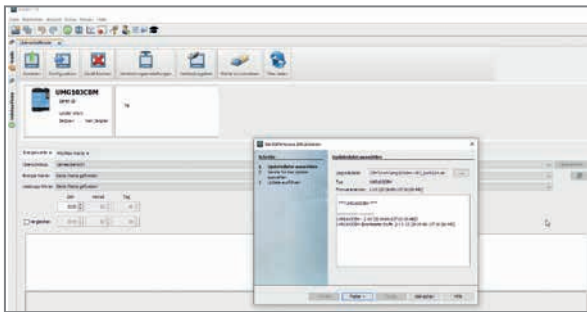





Fig. Updating the device firmware in the GridVis® software

12. Procedure in the event of a malfunction

Failure mode	Cause	Remedy
No LED is lit	External fuse for the supply voltage has tripped.	Replace fuse.
	Device defective.	Send the device to the manufacturer for repair.
The red LED is lit ■	Device defective.	Send the device to the manufacturer for inspection.
The LEDs blink alternately. 	Firmware checksum error. Operation is faulty.	Perform a firmware update.
Measured current is too high or too low. * Indication if current is too high: Red LED blinks 	Current measurement on the wrong phase.	Check connection and correct if necessary.
	Current transformer factor incorrectly programmed	Read and program the current transformer ratio on the current transformer.
	The peak current value at the measuring input was exceeded by current harmonics.	Install current transformers with a higher current transformer ratio.
	The current at the measuring input is too low.	Install current transformers with a lower current transformer ratio.
The measured voltage is too high or too low. * Display when voltage is too high: Red LED blinks 	Measurement on the wrong phase.	Check connection and correct if necessary.
	Voltage transformer programmed incorrectly.	Read the voltage transformer ratio on the voltage transformer and program.
Measured voltage * is too low.	Underrange.	Use a voltage transformer.
	The voltage peak value at the measuring input is exceeded by harmonics.	Attention! Make sure that the measuring inputs are not overloaded.
The active power is too high * or too low. *	The programmed current transformer ratio is incorrect	Read and program the current transformer ratio on the current transformer.
	A current circuit is assigned to the wrong voltage circuit.	Check connection and correct if necessary.
	The programmed voltage transformer ratio is incorrect	Read the voltage transformer ratio on the voltage transformer and program.
Active power consumed/delivered is reversed.	At least one current transformer connection is reversed.	Check connection and correct if necessary
	A current circuit is assigned to the wrong voltage circuit.	
No connection to the device. The LEDs blink simultaneously. 	RS-485 - Incorrect device address. - Different bus speeds (baud rate) and / or data frames - Incorrect protocol. - No termination.	- Correct the device address. - Correct the speed (baud rate). - Correct the data frame. - Correct the protocol. - Terminate bus with termination resistor.
Despite the above measures, the device does not function.	Device defective.	Send the device and error description to the manufacturer for inspection.

ATTENTION

Material damage due to overloaded measuring inputs!
Too high current and voltage values overload the measuring inputs.
Adhere to the limit values specified on the rating plate and in the technical data.

13. Technical data

13.1 Technical data

General	
Net weight (with attached plug-in connectors)	approx. 200 g (0.44 lbs)
Device dimensions (W x H x D)	71.5 x 98 x 46 mm (2.82 x 3.86 x 1.18 in)
Transport and storage	
The following information applies to devices that are transported or stored in their original packaging.	
Free fall	1m (39.37 in)
Temperature	-20 °C ... +70 °C (68 °F ... 158 °F)
Relative humidity	0 to 90% RH

Environmental conditions during operation	
The device: <ul style="list-style-type: none"> • Is for weather-protected and stationary use. • Fulfills the operating conditions according to DIN IEC 60721-3-3 • Has protection class II according to IEC 60536 (VDE 0106, part 1) and does not require a ground wire connection. 	
Working temperature range	-25 °C .. +60°C (-13 °F ... 140 °F)
Relative humidity	5 % to 95 % (at +25 °C / 77 °F), no condensation
Operating elevation	0 .. 2000 m (6562 ft) above sea level
Pollution degree	2
Housing flammability classification	UL 94V-0
Mounting orientation	As desired
Installation/assembly	DIN rail, 35 mm, to IEC/EN60999-1, DIN EN50022
Ventilation	No forced ventilation required.
Stress due to impact	2 joules, IK07 according to IEC/EN61010-1:2010
Protection against foreign matter and water	IP 20 according to EN60529, September 2000, IEC60529:1989

Measurement data recording	
Memory (flash)	4 MB
Battery (soldered), typical life expectancy	BR 1632, 3V, 8-10 years

Firmware	
Firmware update	Update via GridVis software. Firmware download at www.janitza.de

Supply voltage	
The device obtains the supply voltage from the measured voltage.	
Supply from 1st phase	115 - 277 V (+-10%), 50/60 Hz
Supply from 3 phases	80 - 277 V (+-10%), 50/60 Hz
Power consumption	max. 1.5 VA

Voltage measurement	
3-phase 4-wire systems with nominal voltages (L-N/L-L)	max. 277 V/480 V
Networks	Measurement in TT and TN networks
Rated surge voltage	4 kV
Protection of the voltage measurement	1 - 10 A tripping characteristic B, (with IEC/UL approval)
Overvoltage category	300 V CAT III
Resolution	0.01 V
Crest factor	2 (relative to 240 Vrms)
Sampling frequency	5.4 kHz
Frequency of the fundamental oscillation - Resolution	45 Hz .. 65 Hz 0.001 Hz
Fourier analysis	1st-40th harmonic

Current measurement	
Nominal current	5 A
Rated current	6 A
Crest factor	2 (relative to 6 Arms)
Resolution	0.1 mA
Measuring range	0.005 .. 6 Arms
Overvoltage category	300 V CAT II
Rated surge voltage	2 kV
Power consumption	approx. 0.2 VA (Ri = 5 mΩ)
Overload for 1 s	60 A (sinusoidal)
Sampling frequency	5.4 kHz/phase

Serial interface (RS485)	
Protocol, Modbus RTU	Modbus RTU/Slave
Transmission rate	9.6 kbps, 19.2 kbps, 38.4 kbps, 57.6 kbps, 115.2 kbps, Factory setting: automatic detection

Terminal connection capacity	
Connectible conductors. Only connect one conductor per terminal point!	
Single core, multi-core, fine-stranded	0.08 - 2.5 mm ² , AWG 28-12
Tightening torque	max. 0.5 Nm (4.43 lbf in)
Strip length	min. 8 mm (0.2756 in)

13.2 Measuring accuracy

The measuring accuracy of the UMG103-CBM applies to the use of the following measuring ranges. The measured value must be within the specified limits. Outside these limits, the measuring accuracy is not specified.

The specification is valid under the following conditions:

- Annual recalibration,
- A preheating time of 10 minutes,
- An ambient temperature of 18-28 °C.

If the device is operated outside the range of 18-28 °C, an additional measuring error of $\pm 0.01\%$ of the measured value per °C deviation must be taken into account.

Function	Symbol	Accuracy class	Measuring range
Total active power	P	0.5 (IEC61557-12)	0 W .. 12.6 kW
Total reactive power	QA, Qv	1 (IEC61557-12)	0 var .. 16.6 kvar
Total apparent power	SA, Sv	0.5 (IEC61557-12)	0 VA .. 12.6 kVA
Total active energy	Ea	0.5 (IEC61557-12) 0.5S (IEC62053-22)	0 Wh .. 999 GWh
Total reactive energy	ErA, ErV	1 (IEC61557-12)	0 varh .. 999 Gvarh
Total apparent energy	EapA, EapV	0.5 (IEC61557-12)	0 VAh .. 999 GVAh
Frequency	f	0.05 (IEC61557-12)	45 Hz .. 65 Hz
Phase current	I	0.5 (IEC61557-12)	0 Arms .. 6 Arms
Neutral conductor current calculated	INc	1.0 (IEC61557-12)	0.03 A .. 25 A
Voltage	U L-N	0.2 (IEC61557-12)	10 Vrms .. 600 Vrms
Voltage	U L-L	0.2 (IEC61557-12)	18 Vrms .. 1000 Vrms
Power factor	PFA, PFV	0.5 (IEC61557-12)	0.00 .. 1.00
Voltage harmonics	Uh	Cl. 1 (IEC61000-4-7)	1 .. 40
THD of voltage ¹⁾	THDu	1.0 (IEC61557-12)	0% .. 999%
THD of voltage ²⁾	THD-Ru	-	-
Current harmonics	Ih	Cl. 1 (IEC61000-4-7)	1 .. 40
THD of current ¹⁾	THDi	1.0 (IEC61557-12)	0% .. 999%
THD of current ²⁾	THD-Ri	-	-

1) Referenced to the fundamental oscillation.

2) Referenced to the effective value.

13.3 Modbus addresses of frequently used measured values

Address	Format	RD/WR	Variable	Unit	Comment
19000	float	RD	_ULN[0]	V	Voltage L1-N
19002	float	RD	_ULN[1]	V	Voltage L2-N
19004	float	RD	_ULN[2]	V	Voltage L3-N
19006	float	RD	_ULL[0]	V	Voltage L1-L2
19008	float	RD	_ULL[1]	V	Voltage L2-L3
19010	float	RD	_ULL[2]	V	Voltage L3-L1
19012	float	RD	_ILN[0]	A	Apparent current, L1
19014	float	RD	_ILN[1]	A	Apparent current, L2
19016	float	RD	_ILN[2]	A	Apparent current, L3
19018	float	RD	_I_SUM3	A	Sum; $I_N=I_1+I_2+I_3$
19020	float	RD	_PLN[0]	W	Active power L1
19022	float	RD	_PLN[1]	W	Active power L2
19024	float	RD	_PLN[2]	W	Active power L3
19026	float	RD	_P_SUM3	W	Sum; $P_{sum3}=P_1+P_2+P_3$
19028	float	RD	_SLN[0]	VA	Apparent power L1
19030	float	RD	_SLN[1]	VA	Apparent power L2
19032	float	RD	_SLN[2]	VA	Apparent power L3
19034	float	RD	_S_SUM3	VA	Sum; $S_{sum3}=S_1+S_2+S_3$
19036	float	RD	_QLN[0]	var	Reactive power (mains frequency) L1
19038	float	RD	_QLN[1]	var	Reactive power (mains frequency) L2
19040	float	RD	_QLN[2]	var	Reactive power (mains frequency) L3
19042	float	RD	_Q_SUM3	var	Sum; $Q_{sum3}=Q_1+Q_2+Q_3$
19044	float	RD	_COS_PHI[0]		Fund. power factor, CosPhi; UL1 IL1
19046	float	RD	_COS_PHI[1]		Fund. power factor, CosPhi; UL2 IL2
19048	float	RD	_COS_PHI[2]		Fund. power factor, CosPhi; UL3 IL3
19050	float	RD	_FREQ	Hz	Frequency
19052	float	RD	_PHASE_SEQ		Rotating field; 1=right, 0=none, -1=left
19054*	float	RD	_WH_V[0]	Wh	Active energy L1, applied
19056*	float	RD	_WH_V[1]	Wh	Active energy L2, applied
19058*	float	RD	_WH_V[2]	Wh	Active energy L3, referred
19060	float	RD	_WH_V_HT_SUML13	Wh	Active energy L1..L3
19062	float	RD	_WH_V[0]	Wh	Active energy L1, applied
19064	float	RD	_WH_V[1]	Wh	Active energy L2, applied
19066	float	RD	_WH_V[2]	Wh	Active energy L3, referred
19068	float	RD	_WH_V_HT_SUML13	Wh	Active energy L1..L3, applied, tariff 1
19070	float	RD	_WH_Z[0]	Wh	Active energy L1, delivered

* The assignment of the marked device addresses does not correspond to the assignment of other devices of the UMG series.

Address	Format	RD/WR	Variable	Unit	Comment
19072	float	RD	_WH_Z[1]	Wh	Active energy L2, delivered
19074	float	RD	_WH_Z[2]	Wh	Active energy L3, delivered
19076	float	RD	_WH_Z_SUML13	Wh	Active energy L1..L3, delivered
19078	float	RD	_WH_S[0]	VAh	Apparent energy L1
19080	float	RD	_WH_S[1]	VAh	Apparent energy L2
19082	float	RD	_WH_S[2]	VAh	Apparent energy L3
19084	float	RD	_WH_S_SUML13	VAh	Apparent energy L1..L3
19086*	float	RD	_IQH[0]	varh	Reactive energy, inductive, L1
19088*	float	RD	_IQH[1]	varh	Reactive energy, inductive, L2
19090*	float	RD	_IQH[2]	varh	Reactive energy, inductive, L3
19092	float	RD	_IQH_SUML13	varh	Reactive energy L1..L3
19094	float	RD	_IQH[0]	varh	Reactive energy, inductive, L1
19096	float	RD	_IQH[1]	varh	Reactive energy, inductive, L2
19098	float	RD	_IQH[2]	varh	Reactive energy, inductive, L3
19100	float	RD	_IQH_SUML13	varh	Reactive energy L1..L3, ind.
19102	float	RD	_CQH[0]	varh	Reactive energy, capacitive, L1
19104	float	RD	_CQH[1]	varh	Reactive energy, capacitive, L2
19106	float	RD	_CQH[2]	varh	Reactive energy, capacitive, L3
19108	float	RD	_CQH_SUML13	varh	Reactive energy L1..L3, cap.
19110	float	RD	_THD_ULN[0]	%	Harmonics, THD,U L1-N
19112	float	RD	_THD_ULN[1]	%	Harmonics, THD,U L2-N
19114	float	RD	_THD_ULN[2]	%	Harmonics, THD,U L3-N
19116	float	RD	_THD_ILN[0]	%	Harmonics, THD,I L1
19118	float	RD	_THD_ILN[1]	%	Harmonics, THD,I L2
19120	float	RD	_THD_ILN[2]	%	Harmonics, THD,I L3

13.3.1 Number formats

Type	Size	Minimum	Maximum
short	16 bit	-2 ¹⁵	2 ¹⁵ - 1
ushort	16 bit	0	2 ¹⁶ - 1
int	32 bit	-2 ³¹	2 ³¹ - 1
uint	32 bit	0	2 ³² - 1
float	32 bit	IEEE 754	IEEE 754

13.3.2 Note on saving measured values and configuration data

INFORMATION

The device stores the following measured values every 5 minutes:

- Min. / max. / average values
- Energy values (work values)

The device saves configuration values immediately!

13.4 Dimensional drawings

- The figures are for illustration purposes only and are not to scale.

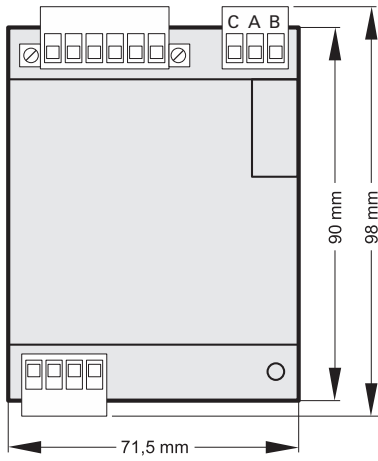

Fig. Front view

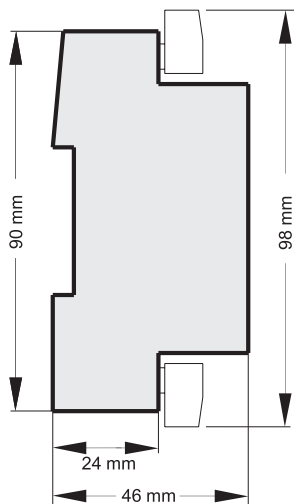
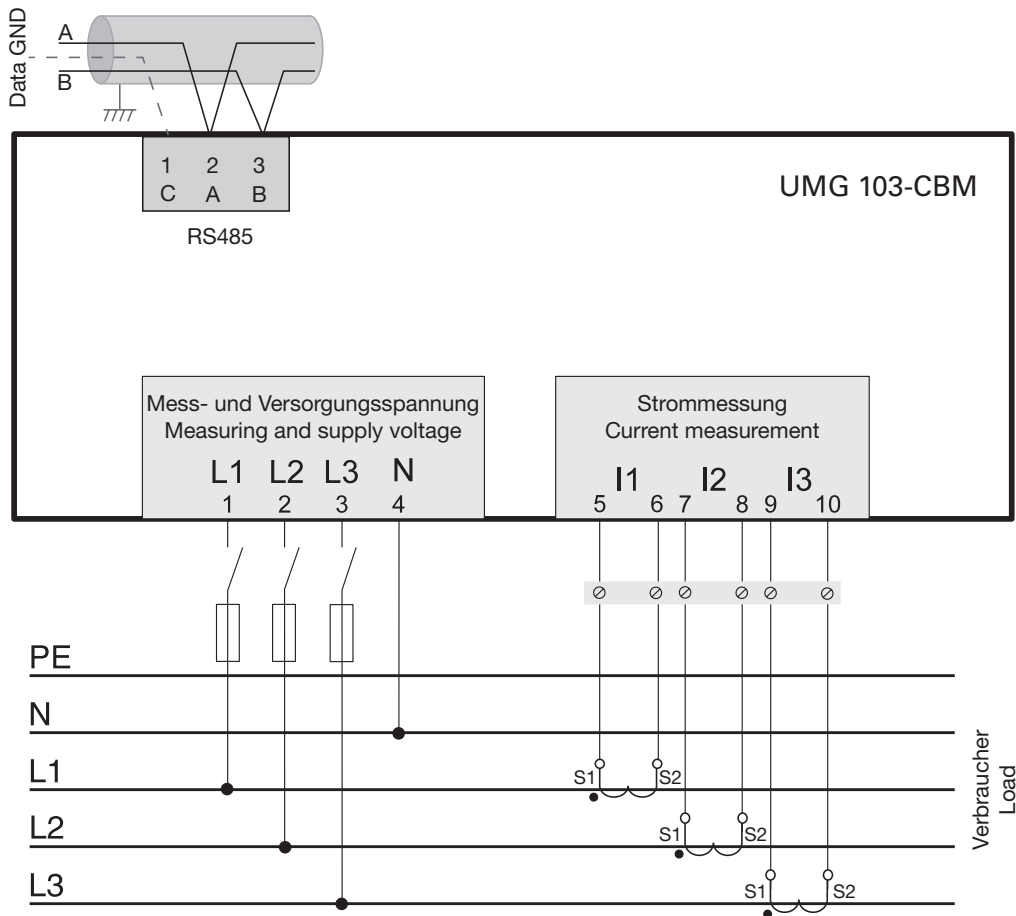

Fig. Side view

13.5 Connection example

The circuit diagram shows a connection variant of the device with:

- Supply voltage and voltage measurement.
- Current measurement.
- RS-485 interface with Modbus RTU protocol.



Connection variant in three-phase four-wire system".

Janitza[®]

Janitza electronics GmbH
Vor dem Polstück 6 | 35633 Lahnau
Germany

Tel. +49 6441 9642-0
info@janitza.com | www.janitza.com