

Modular Power Analyzer

UMG 801

User manual and technical specifications

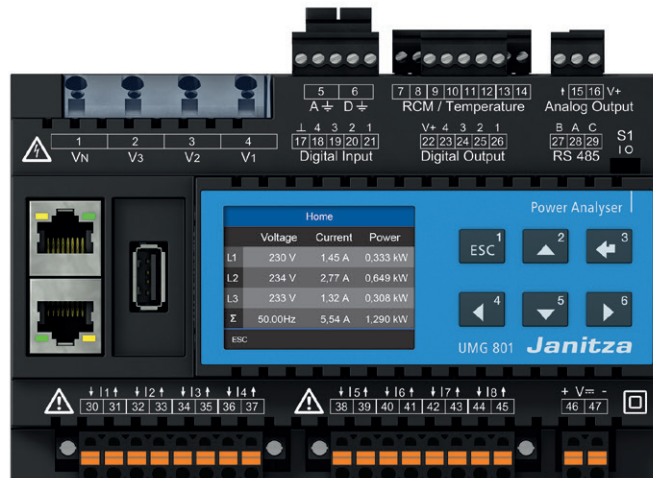

UMG 801
Modular multifunctional meter for
recording energy quantities

Doc. no.: 2.053.021.1.f

Date: 09/2021

The German version is the original edition of the documentation

Subject to technical changes.

The contents of our documentation have been compiled with great care and reflect the current state of the information available to us. Nonetheless, we wish to point out that updates of this document are not always possible at the same time as technical refinements are implemented in our products. Please see our website under www.janitza.de for the current version.

Please see our website under www.janitza.de for the current version.

Table of contents

1. Information on the device and the user manual	10
1.1 Disclaimer.....	10
1.2 Copyright notice.....	10
1.3 Technical changes.....	10
1.4 About this user manual.....	10
1.5 Defective device/disposal.....	11
2. Safety	12
2.1 Display of warning notices and safety information.....	12
2.2 Hazard levels.....	12
2.3 Product safety.....	13
2.4 Dangers when handling the device.....	13
2.5 Electrically qualified personnel.....	14
2.6 Warranty in the event of damage.....	14
2.7 Safety information for handling current transformers and measurement devices with residual current measurement.....	14
2.8 Handling batteries/accumulators.....	15
3. Product description	16
3.1 Device description.....	16
3.2 Incoming goods inspection.....	16
3.3 Intended use.....	17
3.4 Performance characteristics.....	18
3.5 EU conformity declaration.....	18
3.6 FCC Declaration of Conformity.....	18
3.7 Scope of delivery.....	19
3.8 Accessories.....	19
3.9 Measuring method.....	20
3.10 Transformer.....	20
3.11 Operating concept.....	20
3.12 GridVis® network analysis software.....	20
3.13 Overview of the range of functions.....	21
3.13.1 Configuration on the device (via 6 buttons).....	21
3.13.2 Communication.....	21
3.13.3 Measured values (with voltage component).....	21
3.13.4 Measured values (with current component).....	22

4. Structure of the device	24
4.1 Front panel and display.....	24
4.2 Side views.....	26
4.3 Bottom view.....	26
4.4 Identification of the device (rating plate).....	27
5. Mounting	28
5.1 Installation location.....	28
5.2 Mounting orientation and attachment.....	28
6. Grid systems	30
7. Installation	32
7.1 Nominal voltages.....	32
7.1.1 Three-phase 4-conductor network with grounded neutral conductor.....	32
7.2 Disconnect switch.....	33
7.3 Supply voltage.....	33
7.4 Voltage measurement.....	34
7.4.1 Overvoltage.....	35
7.4.2 Mains frequency.....	35
7.4.3 Connection variants for voltage measurement.....	36
7.5 Current measurement.....	37
7.5.1 Connection variants for current measurement.....	38
7.5.2 Summation current measurement.....	39
7.5.3 Ammeter.....	39
7.6 Multifunction channels.....	40
7.7 Residual current measurement (RCM).....	40
7.7.1 Current direction of the residual current transformers.....	41
7.7.2 Residual current transformer example.....	42
7.7.3 Important information about the residual current measuring inputs.....	42
7.7.4 Connection examples - Residual current measurement.....	43
7.7.5 Connection example - Residual current monitoring.....	44

7.8	Residual current measurement - limit value calculation.....	45
7.8.1	Static limit value calculation.....	45
7.8.2	Dynamic limit value calculation.....	46
7.8.3	Stepwise limit value calculation.....	47
7.8.4	Example: Residual current limit value exceeded.....	48
7.8.5	Activating cable break detection (failure monitoring) RCM for the multifunction channels.....	49
7.9	Temperature measurement.....	50
8.	PC connection.....	51
8.1	Connection to a PC.....	51
9.	Peripherals.....	52
9.1	Ethernet interface.....	52
9.2	Daisy chain connection.....	52
9.3	RS-485 interface (serial interface).....	53
9.3.1	Shielding.....	54
9.3.2	Termination resistors/Termination.....	54
9.3.3	Bus structure (bus segment).....	55
9.4	JanBus interface.....	55
9.5	Digital inputs.....	56
9.6	Digital outputs.....	58
9.7	Analog outputs.....	59
10.	Operation and button functions.....	60
10.1	Controls.....	60
10.2	Function buttons.....	60
10.3	Measuring display.....	60
10.4	Menu.....	60
10.5	PIN (password).....	61
10.6	Overview of menu displays.....	62

11. Configuration	64
11.1 The Configuration window.....	64
11.2 Configuring Ethernet (TCP/IP).....	64
11.2.1 Communication settings.....	65
11.2.2 Communication via OPC UA.....	65
11.3 Configuring the fieldbus (RS-485 interface).....	66
11.3.1 Communication settings.....	66
11.4 Configuring current transformers.....	67
11.5 Configuring voltage transformers.....	68
11.6 Configuring the display.....	69
11.6.1 Language.....	69
11.6.2 Standby (after).....	69
11.7 Configuring the system.....	70
11.7.1 PIN.....	70
11.7.2 Brightness.....	70
11.7.3 Time.....	71
11.7.4 Date.....	71
11.8 Reset.....	72
11.8.1 Standard factory settings.....	72
11.8.2 Restart.....	72
11.8.3 Reset minimum, maximum and average values.....	73
11.9 Module identification / diagnostics.....	73
12. Digital inputs and outputs	74
12.1 4 digital inputs.....	74
12.2 4 digital outputs.....	76
13. Analog outputs	78

14. Commissioning	80
14.1 Supply voltage.....	80
14.2 Measured voltage.....	80
14.3 Measured current.....	81
14.4 Frequency measurement.....	81
14.5 Direction of rotary field.....	82
14.6 Fundamentals on the phasor diagram.....	83
14.7 Checking individual power.....	84
14.8 Checking of voltage and current inputs by means of phasor diagram.....	84
14.9 Checking the phase assignment.....	84
14.10 Checking the power measurement.....	84
14.11 Checking measurement.....	84
14.12 Checking summation power.....	85
15. Overview of measured value and meter displays	86
16. Connection example	96
17. Service and maintenance	98
17.1 Repair and calibration.....	98
17.2 Front panel foil and display.....	98
17.3 Service.....	98
17.4 Device adjustment.....	99
17.5 Firmware update.....	99
17.6 Clock/Battery.....	99
17.7 Battery replacement.....	99
18. Error messages	100
18.1 Overrange.....	100
18.2 Procedure in the event of a malfunction.....	101

19. Technical data	102
19.1 Technical data.....	102
19.2 Performance characteristics of functions.....	108
19.3 Parameter and Modbus address list.....	109
19.4 Information on saving measured values and configuration data.....	109
20. Dimensional drawings	110

1. Information on the device and the user manual

1.1 Disclaimer

Compliance with the informational products for the device is a prerequisite for safe operation and attaining the stated performance characteristics and product features.

Janitza electronics GmbH assumes no liability for bodily injury, material damage or financial losses which result from disregard of the informational products.

Ensure that your informational products are readily accessible in a legible form.

1.2 Copyright notice

© 2019 - Janitza electronics GmbH - Lahnau.
All rights reserved.

Any reproduction, processing, distribution or other use of this informational product, in whole or in part, is prohibited.

All trademarks and the rights arising from them are the property of the respective owners of these rights.

1.3 Technical changes

- Make sure that your device matches the user manual.
- This user manual applies to the UMG 801. Separate validities and distinctions are marked.
- First read and understand the documents associated with the product.
- Keep the documents associated with the product available for the entire service life and pass them on to any possible subsequent users.
- Find out about device revisions and the associated modifications of the documentation associated with your product at www.janitza.de.

1.4 About this user manual

If you have questions, suggestions or ideas for improvement of the user manual, please let us know via email at: info@janitza.de.

INFORMATION

This user manual describes the UMG 801 and provides information on the operation of the device. Also consult the additional documentation relevant for this user manual, such as:

- Installation instructions.
 - Data sheet.
 - Safety information.
 - As applicable, documents for expansion modules.
 - Online help for the network visualization software GridVis®.
-

1.5 Defective device/disposal

Before sending **defective devices, modules or components** back to the manufacturer for testing:

- Contact the manufacturer's Support department.
- Send devices, modules or components complete with all accessories.
- When doing so, please bear the terms for transportation in mind.

INFORMATION

Please return defective or damaged devices to Janitza electronics GmbH in accordance with the shipping instructions for air or road freight (complete with accessories).

Observe special regulations for devices with built-in batteries or rechargeable batteries!

Do not attempt to open or repair the device (the component) on your own because otherwise all warranty claims become invalid!

For the **Disposal** of the device please observe national regulations! Dispose of individual parts, as applicable, depending on their composition and existing country-specific regulations, e.g. as

- Electronic waste,
- Batteries and rechargeable batteries.
- Plastics.
- Metals.

Engage a certified disposal company to handle scrapping as needed.

Information on service and maintenance of your device can be found in chapter „17. Service and maintenance“ on page 98.

2. Safety

The chapter on Safety contains information which must be observed to ensure your personal safety and avoid material damage.

2.1 Display of warning notices and safety information

The warning notices shown below

- are found throughout all of the documentation,
- can be found on the devices themselves,
- indicate potential risks and hazards,
- underscore aspects of the information provided that clarifies or simplifies procedures.



The additional symbol on the device itself indicates an electrical danger that can result in serious injuries or death.



This general warning symbol draws attention to a possible risk of injury. Be certain to observe all of the information listed under this symbol in order to avoid possible injury or even death.



2.2 Hazard levels

Warning and safety information is marked by a warning symbol, and the hazard levels are shown as follows, depending on the degree of hazard:

DANGER

Warns of an imminent danger which, if not avoided, results in serious or fatal injury.

WARNING

Warns of a potentially hazardous situation which, if not avoided, could result in serious injury or death.

CAUTION

Warns of an immediately hazardous situation which, if not avoided, can result in minor or moderate injury.

ATTENTION

Warns of an immediately hazardous situation which, if not avoided, can result in material or environmental damage.

INFORMATION

Indicates procedures in which there is **no** hazard of personal injury or material damage.

2.3 Product safety

The device reflects current engineering practice and accepted safety standards, but hazards can arise nonetheless.

Observe the safety regulations and warning notices. If notices are disregarded, this can lead to personal injury and/or damage to the product.

Every type of tampering with or use of this device,

- which goes beyond the mechanical, electrical or other operating limits can lead to personal injury and/or damage to the product;
- constitutes “misuse” and/or “negligence” under the product’s warranty and thus voids the warranty for any possible resulting damage.

Read and understand the user manual before installing, operating, maintaining and using the device.

Only operate the device when it is in perfect condition and in compliance with this user manual and the associated, included documents. Send defective devices back to the manufacturer in compliance with proper transport conditions. Retain the user manual throughout the service life of the device and keep it at hand for consultation.

When using the device, also observe the legal and safety regulations for your system that are applicable for the respective use case.

2.4 Dangers when handling the device

When operating electric devices, it is unavoidable for certain parts of these devices to conduct hazardous voltage. Consequently, severe bodily injury or material damage can occur if they are not handled properly.

Therefore, when handling our devices, always observe the following:

- do not exceed the limit values specified in the user manual and on the rating plate! This must also be observed during testing and commissioning!
- Safety and warning notices in all documents that belong to the devices!

WARNING

Disregarding the connection conditions of the Janitza measurement devices or their components can lead to injuries and even death or to material damage!

- Do not use Janitza measurement devices or components for critical switching, control or protection applications where the safety of persons and property depends on this function.
- Do not carry out switching operations with the Janitza measurement devices or components without prior inspection by your plant manager with specialist knowledge! In particular, the safety of persons, material assets and the applicable standards must be taken into account!

WARNING

Risk of injury due to electrical voltage!

Severe bodily injury or death can result! Therefore please abide by the following:

- **Switch off your installation before commencing work! Secure it against being switched on! Check to be sure it is de-energized! Ground and short circuit! Cover or block off adjacent live parts!**
- **During operation and troubleshooting (especially for DIN rail devices), check your system for dangerous voltages and switch these off if necessary!**
- **Wear protective clothing and protective equipment in accordance with applicable guidelines when working on electrical systems!**
- **Before making connections to the device/the component, ground the device by means of the ground wire connection, if present.**
- **Do not touching bare or stripped leads that are energized! Equip stranded conductors with wire ferrules!**
- **Hazardous voltages can be present in all circuitry parts that are connected to the power supply.**
- **Protect wires, cables and devices with a suitable line circuit breaker/fuse!**
- **Never switch off, remove or tamper with safety devices!**
- **There can still be hazardous voltages present in the device or in the component even after it has been disconnected from the supply voltage (capacitor storage).**
- **Do not operate equipment with current transformer circuits when open.**
- **Only connect screw terminals with the same number of poles and design!**
- **Do not exceed the limit values specified in the user manual and on the rating plate! This must also be observed during testing and commissioning.**
- **Take note of the safety and warning notices in the documents that belong to the device!**

2.5 Electrically qualified personnel

To avoid bodily injury and material damage, only electrically qualified personnel are permitted to work on the devices and their components, modules, assemblies, systems and current circuits who have knowledge of:

- the national and international accident prevention regulations,
- safety technology standards,
- installation, commissioning, operation, disconnection, grounding and marking of electrical equipment,
- the requirements concerning personal protective equipment.

Electrically qualified persons within the scope of the technical safety information of all documents associated with the device and its components are persons who can furnish proof of qualification as an electrically skilled person.

 WARNING
<p>Warning against unauthorized manipulation or improper use of the device or its components! Opening, dismantling or unauthorized manipulation of the device and its components which goes beyond the mechanical, electrical or other operating limits indicated can lead to material damage or injury, up to and including death.</p> <ul style="list-style-type: none"> · Only electrically qualified personnel are permitted to work on the devices and their components, assemblies, systems and current circuits. · Always use your device or component only in the manner described in the associated documentation. · If there is discernable damage, send the device or the component back to the manufacturer!

2.6 Warranty in the event of damage

Any unauthorized tampering with or use of the device constitutes “misuse” and/or “negligence” under the product’s warranty and thus voids the warranty of any possible resulting damage. In this regard, please take note of chap. „3.3 Intended use“ on page 17.

2.7 Safety information for handling current transformers and measurement devices with residual current measurement

 WARNING
<p>Risk of injury due to large currents and high electrical voltage on the current transformers! Current transformers operated while open on the secondary side (high voltage peaks pose a hazard when touched) can result in severe bodily injury or death.</p> <ul style="list-style-type: none"> · Avoid operating the current transformers while open; short circuit the unloaded transformers! · Before interrupting the current supply, short circuit the secondary connections of the current transformers. Switch any test switches that automatically short circuit the secondary lines of the current transformers to the “Test” status (Check the test switch/short circuiting connection beforehand)! · Only use current transformers with basic insulation to IEC 61010-1:2010! · Caution, even current transformers rated as safe for open operation can pose a hazard when touched during operation while open! · Make sure that screw terminals for the current transformer connection on the device are adequately tightened! · Comply with the information and provisions in the documentation of your current transformers!

 CAUTION
<p>Risk of injury or damage to the meter due to high measurement currents at the connections of the current transformers! High measurement currents can cause temperatures of up to 80 °C (176 °F) on the connections of the current transformers</p> <ul style="list-style-type: none"> · Use wiring that is designed for an operating temperature of at least 80 °C (176 °F)! · The current transformers can be hot even after the power supply has been switched off. Allow the connections of the current transformers and the connecting cables to cool down before touching them!

 WARNING
<p>Risk of injury or damage to the meter due to improper use! Meters with residual current measurement can trigger warning pulses if limit values are exceeded, and these are used exclusively for monitoring residual currents or failure monitoring. Use of the warning pulses as a stand-alone protective device against electrical shock can lead to injury and even death!</p> <ul style="list-style-type: none"> · Do not use devices with residual current measurement as a stand-alone protective device. Employ suitable protective devices for your system!

 **CAUTION****Risk of injury or damage to the meter/your system due to short circuit!**

Inadequate insulation of the operating equipment at the residual current measuring input with respect to the supply circuits can cause voltages at the measuring input which represent a hazard when touched or damage to your device or system.

- **Ensure reinforced or double insulation with respect to the supply circuits!**
- **Ensure galvanic isolation of the residual current measuring inputs from each other!**

2.8 Handling batteries/accumulators

The following apply for the battery used in the device:

 **CAUTION****Risk of injury due to fire or burns!**

The battery used in the device may cause fire or burns if used improperly.

- **Only replace the battery with the same type or types recommended by Janitza!**
- **Observe the polarity when installing the battery!**
- **Remove batteries only with non-conductive tools (e.g. plastic tweezers)!**
- **Do not recharge, disassemble, burn or heat batteries above 100 °C (212 °F)!**
- **Do not dispose of batteries with household waste! Follow the disposal instructions in the respective device documentation!**
- **Keep batteries away from children and animals!**
- **In case of damage, return devices with a soldered battery to the manufacturer, observing proper transport conditions!**

3. Product description

3.1 Device description

The device is a multifunctional network analyzer and is suitable for:

- Measurements and calculations of electrical quantities such as voltage, current, power, energy, harmonics current in building installations, on distribution boards, circuit breakers and busbar trunking systems.
- A modular extension of the functional scope using current measuring modules.
- The connection of remote measurement points in the switchboard cabinet or small installation distributors via transfer modules.
- Measurements of voltages and currents from the same network.
- Measurements in low-voltage networks (3-phase 4-conductor systems) in which nominal voltages of up to 480 V from conductors to ground and surge voltages of overvoltage category III occur.
- Measurements in medium and high voltage networks via current and voltage transformers.
- Current measurement via
 - external $\dots/1$ A or $\dots/5$ A current transformers.
 - the multifunction channels (mA current inputs).
- Installation in stationary switch cabinets or small distribution boards, in any mounting orientation.
- The measurement of residual currents (Residual Current Monitoring, RCM) of an electrical system. The measurement device is not a protective device against electric shock!
- Use in industrial areas.

Measurement results are displayed by the measurement device and can be read and processed via interfaces.



CAUTION

Malfunction and damage of the device or risk of injury due to improper connection.

Improperly connected devices can deliver incorrect measured values, damage the device or pose a risk of injury to persons.

Observe the following:

- **That measured voltages and currents come from the same network.**
- **Do not use the device for measuring direct current!**
- **Ground current-conducting switchboards!**

3.2 Incoming goods inspection

Safe and trouble-free operation of this device and its components presupposes proper transport, proper storage, set-up and assembly as well as operation and maintenance in addition to compliance with the safety information and warning notices.

Exercise due caution when unpacking and packing the device, do not use force and only use suitable tools.

Before installing the device, please check the following:

- Its flawless mechanical condition by visual inspection.
- The scope of delivery for completeness.

If it can be assumed that safe operation of the device is no longer possible:

- Disconnect the device from operation immediately!
- Secure the device against being switched on again!

It can be assumed that safe operation is no longer possible if the device, for example:

- Has visible damage.
- No longer functions despite an intact power supply.
- Was subjected to extended periods of unfavorable conditions (e.g. storage outside of the permissible climate thresholds without adjustment to the room climate, condensation, etc.) or transport stress (e.g. falling from an elevated position, even without visible external damage, etc.).

3.3 Intended use

The device is:

- Only for use in the industrial sector.
- Intended for installation in switchboard cabinets and small installation distributors.
- Not intended for installation in vehicles! Use of the device in non-stationary equipment constitutes an exceptional environmental condition and is only permissible by special agreement.
- Not intended for installation in environments with harmful oils, acids, gases, vapors, dusts, radiation, etc.
- Designed as an interior meter.

Safe and trouble-free operation of the device requires proper transport, storage, assembly, installation, operation and maintenance.

3.4 Performance characteristics

General

- DIN rail measurement device with the dimensions 144 x 90 x 76 mm.
- Mounting on DIN rail 35 mm.
- TFT display.
- Operation via 6 buttons.
- Password protection.
- Connection via screw terminals.
- 4 voltage measurement inputs (1000 V, CATIII).
- 2x 4 current measurement inputs (via current transformer).
- RS-485 interface (Modbus RTU, with DIP switch for termination).
- 2x Ethernet interface (RJ45).
- 4 digital inputs.
- 4 digital outputs.
- 1 analog output (galvanically isolated).
- 4 multifunction channels for use as residual current or temperature measuring inputs and additional current measurement channels (mA).
- Clock and battery.

Measurement uncertainty

- Active energy, measurement uncertainty class 0.2 S for $\dots/5$ A transformers.
- Active energy, measurement uncertainty class 0.5 S for $\dots/1$ A transformers.
- Active energy, measurement uncertainty class 0.5 S for $\dots/50$ mA transformers.
- Reactive energy, class 1.

Measurement

- Measurement in TN, TT and IT networks
- Measurement in networks with nominal voltages up to L-L 830 V and L-N 480 V.
- Measuring range, voltage 720 $V_{\text{eff L-N}}$; 1000 $V_{\text{eff L-L}}$; 100 $V_{\text{N-PE}}$.
- Measuring range, current 0.005 .. 6 A_{eff}
- True effective value measurement (TRMS)
- Continuous sampling of the voltage and current measurement inputs.
- Frequency range of the fundamental oscillation 40 Hz .. 70 Hz.
- Voltage: 1..127 harmonics and interharmonics.
- Current: 1..63 harmonics.
- Residual current acc. to IEC/TR 60755 (2008-01), type A + type B and B+.

3.5 EU conformity declaration

Please see the EU declaration of conformity posted at www.janitza.de for the laws, standards and directives applied by Janitza electronics GmbH for the devices. The CE conformity marking requirements for the device arise from the EU conformity declaration and the laws, standards and directives mentioned therein.

3.6 FCC Declaration of Conformity



The device:

- complies with Part 15 of the FCC Rules for Class B digital devices (limits to protect against harmful interference in a residential installation).
- generates, uses and can radiate high-frequency energy
- can cause harmful interference to radio communications if not installed and used properly. There is no guarantee that interference will not occur in a particular installation.

If there is radio or television reception interference, which can be determined by turning the device on and off, proceed as follows:

- Align or reposition the receiving antenna.
- Increase the distance between the device and the radio/television receiver.
- Connect the device and the radio/television receiver in different circuits.
- if necessary, contact Janitza support or a radio/television technician.

Code of Federal Regulations, Title 47, Part 15, Subpart B - Unintentional Radiators.

3.7 Scope of delivery

Quantity	Part. no.	Designation
1	52.31.001	UMG 801 (basic device)
1	52.31.205	Bus connector for module connection to the UMG 801 (basic device)
1	33.03.376	Installation instructions DE/EN
1	33.03.342	Supplement "Safety Information"
1	10.01.953	End bracket
1	08.01.505	Patch cable
1	10.01.941	PUSH-IN spring connection terminal, pluggable, 2-pole (supply voltage)
2	10.01.940	PUSH-IN spring connection terminal, pluggable, 8-pole (current measurement I1..I4 and I5..I8)
1	10.01.880	Screw terminal, plug-in, 2-pole (A, D)
1	10.01.891	Screw terminal, plug-in, 8-pole (residual current/temperature measurement)
1	10.01.857	Screw terminal, plug-in, 2-pole (analog output)
1	10.01.863	Screw terminal, plug-in, 5-pole (digital inputs)
1	10.01.863	Screw terminal, plug-in, 5-pole (digital outputs)
1	10.01.909	Screw terminal, plug-in, 3-pole (RS-485)

Tab. Scope of delivery

The screw terminals required for the device are included in delivery.

3.8 Accessories

Quantity	Part. no.	Designation
1	21.01.058	Battery type, Lithium CR2032, 3 V, (approval according to UL 1642)
1	13.09.227	USB cover
1	52.31.201	Module 800-CT8-A (current measuring module)
1	52.31.210	Set module 800-CON (set of 2 transfer modules)

Tab. Accessories

INFORMATION

- All supplied options and design variants are described on the delivery note.

3.9 Measuring method

The device measures continuously and calculates all effective values using:

- A 200 ms period interval.
- The true RMS value (TRMS) of the voltages and currents applied to the measuring inputs.

3.10 Transformer

For Janitza measurement devices and components, use **only** current transformers intended for measuring purposes (“transformers”)!

“Transformers”, unlike “protection transformers”, go into saturation at high current peaks. “Protection transformers” do not have this saturation behavior and can therefore significantly exceed the rated values in the secondary circuit. This can overload the current measurement inputs of the measurement devices!

Furthermore, please note that Janitza measurement devices and components are **not** to be used for critical switching, control or protection applications (protective relays)! Observe the safety and warning information in the “Installation” and “Product safety” chapters!

3.11 Operating concept

The following options are offered for operating, configuring or reading the meter:

- **6 function buttons with display** for configuration and acquisition of data.
- The **GridVis network analysis and programming software**[®] for programming and analysis of data.

A standard Modbus address list is available at www.janitza.de.

This user manual describes how to operate the meter using the 6 keys. The GridVis[®] software has “online help” and e-learning instructions.

3.12 GridVis[®] network analysis software

With the GridVis[®] network analysis software available at www.janitza.de, you can configure your measurement device and read out data for analysis. To do so, connect a PC to your measurement device via the Ethernet interface.

Performance characteristics of the GridVis[®] software

- Configure and read out the device.
- Graphic display of measured values.
- Analysis of read data.
- Store data in databases.
- Create reports.

Connections to the PC

Connections for communication between the PC and the measurement device can be found in chap. „8. PC connection“ on page 51.

3.13 Overview of the range of functions

3.13.1 Configuration on the device (via 6 buttons)

- Password protection (can only be configured on the device) and time.
- Ethernet TCP/IP
- Field bus
- Current transformer primary / secondary
- Voltage transformer primary / secondary
- Language, LCD brightness, standby after
- Factory settings, restart, min./max. values
- Parameters, such as
 - Device address, baud rate (RS-485 interface), data frame (stop bits / parity).

3.13.2 Communication

- One RS-485 interface for communication with Modbus/RTU devices.
- Firmware update via Ethernet.
- 2 Ethernet interfaces for communication via various IP protocols (OPC-UA, Modbus/IP, DHCP, NTP).

3.13.3 Measured values (with voltage component)

Measured values (with voltage component)	Device/system related	Channel related	Min. value	Max. value	Average value
Frequency	1		✓	✓	✓
Rotating field direction U	1		✓ System		
Measurement of positive, negative, zero sequence component	1		✓	✓	✓
Imbalance in %	1		✓	✓	✓
Effective voltage U_{NPE_eff}	1			✓	
Effective voltage U_{LN_eff}		3	✓	✓	✓
Effective voltage U_{LL_eff}		3	✓	✓	✓
Distortion factor U_{LN_THD}		3	✓	✓	✓
Distortion factor U_{LL_THD}		3	✓	✓	✓
Real component Voltage $Re\{U_{LN}\}$		3	✓	✓	✓
Imaginary component Voltage $Im\{U_{LN}\}$		3	✓	✓	✓
Harmonic $U_{LN_1..127}$		3x127		✓	
Interharmonic $U_{LN_0.5..126.5}$		3x127		✓	
Harmonic $U_{LL_1..127}$		3x127		✓	
Interharmonic $U_{LL_0.5..126.5}$		3x127		✓	
Crest factor $U_{LN-Crest}$	3		✓ System		

Tab. Overview of the measured values recorded by the device.
Further information on the measured values can be found in the chap. „19.2 Performance characteristics of functions“ on page 108.

3.13.4 Measured values (with current component)

Measured values (with current component)	Device/system related	Channel related	Min. value	Max. value	Average value
Effective current I_{eff}		12		✓	✓
Real part Current $\text{Re}\{I\}$		12		✓	✓
Imaginary part Current $\text{Im}\{I\}$		12		✓	✓
Active power P		12		✓	✓
Reactive power Q		12		✓	✓
Apparent power S		12		✓	✓
Reactive distortion power D		12		✓	✓
Active power of the fundamental oscillation P_1		12		✓	✓
Reactive power of the fundamental oscillation Q_1		12		✓	✓
Power factor PF		12	✓	✓	✓
Fundamental oscillation power factor $\text{PF}_1 / \text{Cos}(\Phi)$		12	✓	✓	✓
Distortion factor I_{THD}		12		✓	✓
Power distortion factor I_{TDD}		12		✓	✓
Crest factor I_{Crest}		12			
Harmonic I		12			
Rotating field direction I			✓ System		
Measurement of positive, negative, zero sequence component	3			✓	✓
Calculated neutral conductor current $I_{\text{N_calc}}$	3			✓	✓
System total effective current I_{eff}	3			✓	✓
System total active power P	3			✓	✓
System total reactive power Q	3			✓	✓
System total apparent power S	3			✓	✓
System total reactive distortion power D	3			✓	✓
System total Active power of the fundamental oscillation P_1	3			✓	✓
System total Reactive power of the fundamental oscillation Q_1	3			✓	✓
System total Power factor PF	3		✓	✓	✓
System total Fundamental oscillation power factor / $\text{Cos}(\Phi)$ PF_1	3		✓	✓	✓

Tab. Overview of the measured values recorded by the device.

Further information on the measured values can be found in the chap. „19.2 Performance characteristics of functions“ on page 108.

Measured values (with current component)	Device/system related	Channel related	Min. value	Max. value	Average value
Energy (3 tariffs, consisting of 1 main tariff and 2 ancillary tariffs)					
Active energy W_P	3 x 3 tariffs				System total
Active energy W_P applied	3 x 3 tariffs				System total
Active energy W_P delivered	3 x 3 tariffs				System total
Reactive energy W_Q	3 x 3 tariffs				System total
Reactive energy applied W_Q inductive	3 x 3 tariffs				System total
Reactive energy applied W_Q capacitive	3 x 3 tariffs				System total
Reactive energy delivered W_Q inductive	3 x 3 tariffs				System total
Reactive energy delivered W_Q capacitive	3 x 3 tariffs				System total
Apparent energy W_S	3 x 3 tariffs				System total

Tab. Overview of the measured values recorded by the device.

Further information on the measured values can be found in the chap. „19.2 Performance characteristics of functions“ on page 108.

4. Structure of the device

4.1 Front panel and display

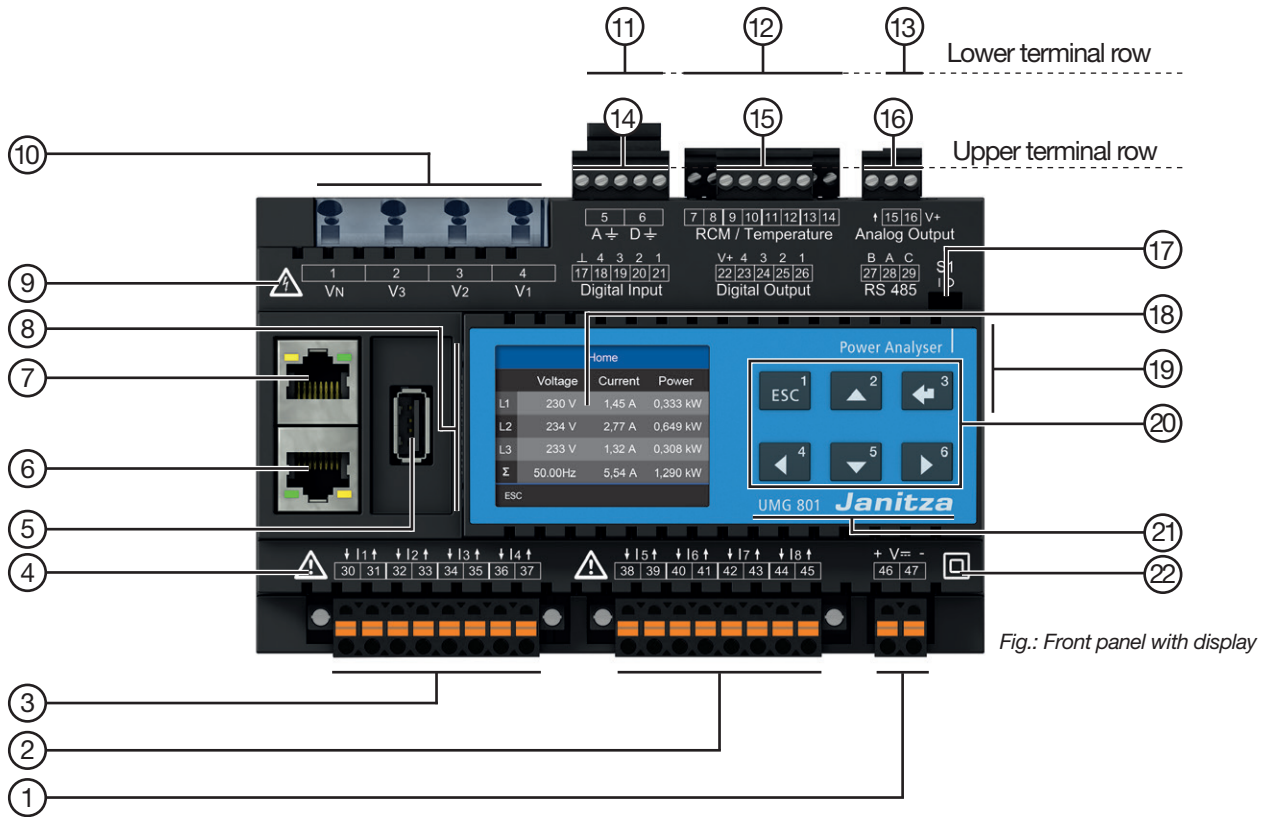

Fig.: Front panel with display

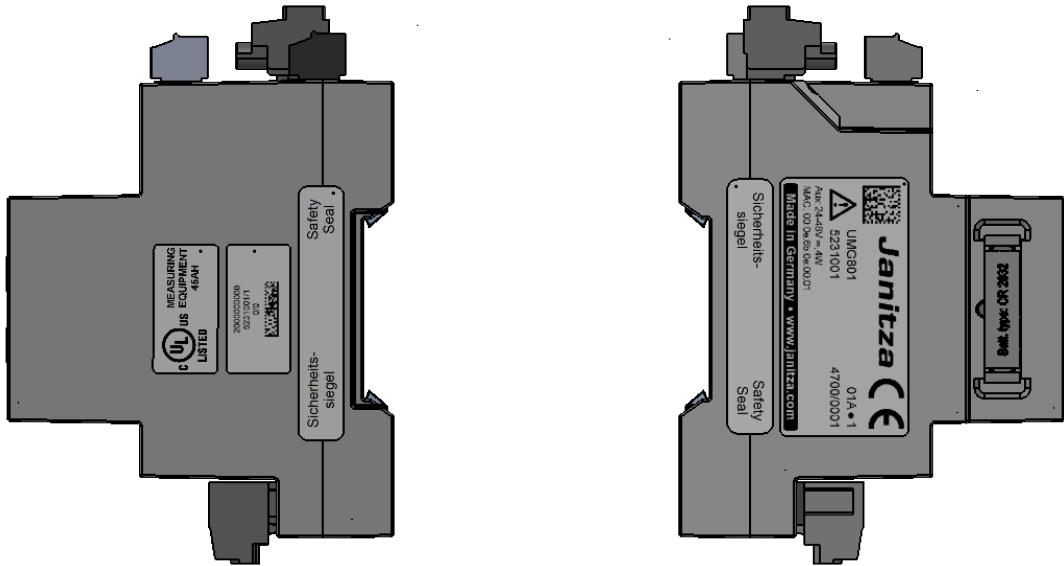

Fig: Front panel with display - 3D

Item	Function/Designation
1	Supply voltage connection
2	Current measurement inputs I5 to I8 for · Measurement of an additional system (L1, L2, L3, N) · Single channel measurements
3	Current measurement inputs I1 to I4 for · Measurement of one system (L1, L2, L3, N) · Single channel measurements
4	“Hazard symbol” – General warning symbol. Be certain to observe the warning notices applied to the device and shown in the usage information in order to avoid possible injury or even death.
5	USB interface (2.0), type A (e.g. connection for the RD 96 external display - optional)
6	Ethernet interface (RJ45)
7	Ethernet interface (RJ45)
8	Battery compartment (type Lithium CR2032, 3 V, UL 1642 approved)
9	“Hazard symbol” – Warning symbol indicating an electrical hazard. Be certain to observe the warning notices applied to the device and shown in the documentation in order to avoid possible injury or even death.
10	Voltage measurement inputs V_1 , V_2 , V_3 and V_N
11	Connections for functional earth
12	Connections for residual current (RCM) and temperature measurement, mA current measuring channels
13	1 analog output
14	4 digital inputs
15	4 digital outputs
16	RS-485 interface
17	DIP switch for RS-485 termination – see chapter „9.3.3 Bus structure (bus segment)“ on page 55
18	Device display
19	Underside of the device: JanBus interface (bus connector connection, module connection)
20	Function buttons 1 - 6 (see chapter „10.2 Function buttons“ on page 60).
21	Device designation and manufacturer logo
22	Symbol “Protection class” - Protection class II (reinforced or double insulation) according to IEC 60536 (VDE 0106, Part 1).

Tab: Device structure - Connections and controls

4.2 Side views



4.3 Bottom view

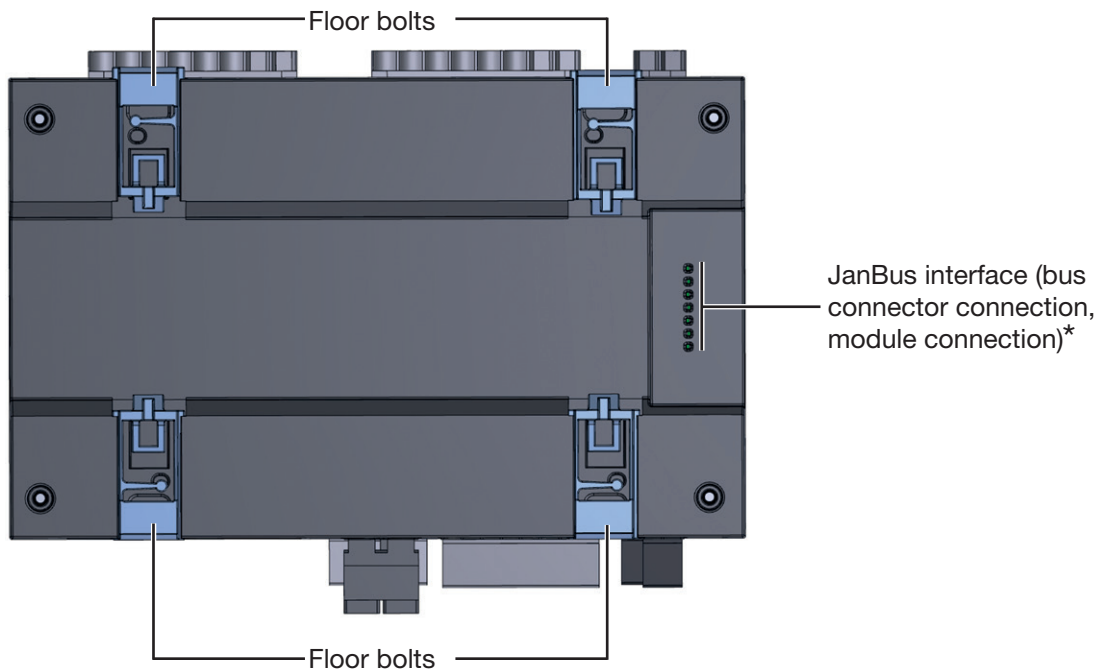

* **i** **INFORMATION**

When the device is delivered, the bus connectors are already plugged into the JanBus interface!

4.4 Identification of the device (rating plate)

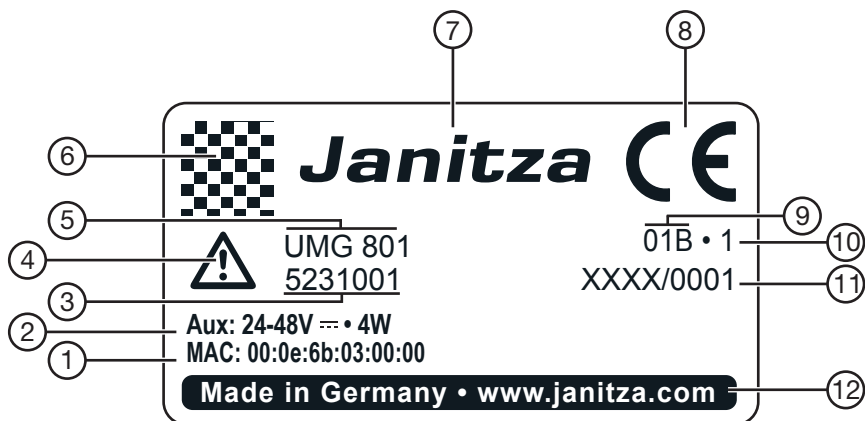

Item	Designation	Description
1	MAC address	Unique identification of the device in a computer network.
2	Operational data	Supply voltage and maximum power consumption.
3	Part number of the measurement device	Manufacturer's part number.
4	Symbol for "Danger sign"	General warning symbol. Be certain to observe the warning notices applied to the device and shown in the usage information in order to avoid possible injury or even death.
5	Device type	Device designation.
6	Data matrix code	Coded manufacturer data.
7	Manufacturer's logo	Logo of the device manufacturer.
8	CE conformity marking	See „Reference value, e.g. power in kW“ on page 46.
9	Manufacturer-specific data	Manufacturer data.
10	Hardware version	Hardware version of the device.
11	Type/serial number	Number for identification of the device.
12	Designation of origin/web address	Country of origin and manufacturer's web address.

Tab: Device identification, rating plate

5. Mounting

5.1 Installation location

⚠ DANGER

Danger of electric shock!
Electric shocks lead to serious injuries, including death.

- Disconnect your system from the power supply before mounting and connecting the device!
- Secure it against being switched on!
- Check to be sure it is de-energized!
- Ground and short circuit!
- Cover or block off adjacent live parts!
- The installation must only be carried out by qualified personnel with electrical training!

Mount the meter in switch cabinets or small distribution boards according to DIN 43880 on a 35 mm mounting rail (for type, see technical data) according to DIN EN 60715. The mounting orientation is arbitrary.

ATTENTION

Material damage due to improper handling or disregard of the assembly instructions!
Incorrect mounting of the UMG 801 can destroy the contacts of the bus connector (JanBus interface)!

- Use suitable mounting rails according to DIN EN 60715 for mounting the meter! For suitable mounting rail types, see the chapter „19. Technical data“ on page 102.
- **Before you begin mounting and wiring your UMG 801 on the mounting rail, plug the bus connector into the sockets on the bottom of the device if this has not yet been done!**
- **Never:**
 - touch or manipulate the contacts of the bus connector!
 - force the contacts into the bus connector sockets!

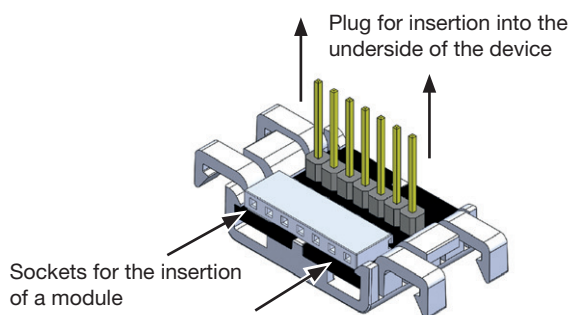

Fig.: Bus connector of the UMG 801 (scope of delivery)

i INFORMATION

When the device is delivered, the bus connectors are already plugged into the JanBus interface!

5.2 Mounting orientation and attachment

Proceed as follows to mount the UMG 801 on the mounting rail:

1. Check the installation of the bus connector (included in delivery, pre-assembled) on the bottom of your device. If not already done, plug the bus connector into the sockets on the bottom of the meter (see figures).

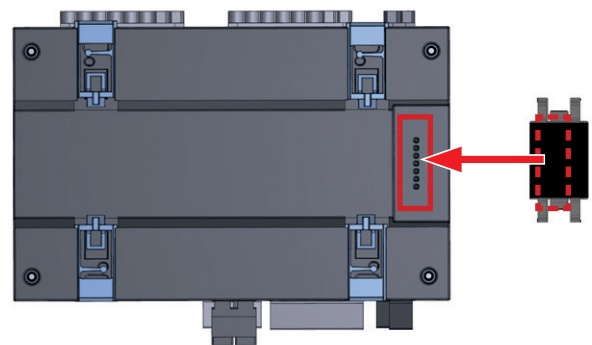

Fig. Device and bus connector underside

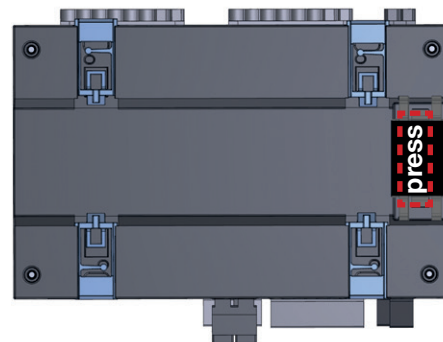

Fig. Device underside with bus connector installed

2. Push in the floor bolt of the clamping mechanism.

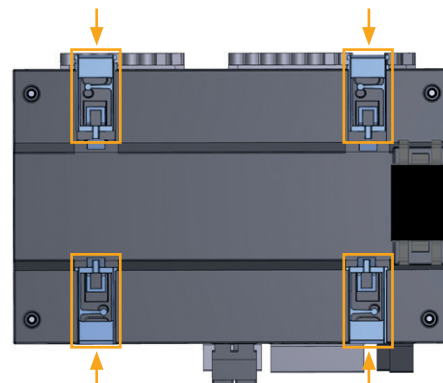

Fig. Underside of device with bus connector installed and floor bolt pressed in.

- ③ Press your meter with the bus connector onto the mounting rail frontally until the 4 floor bolts engage.

The UMG 801 is suitable for connecting up to 10 modules via the bus connector (JanBus interface).

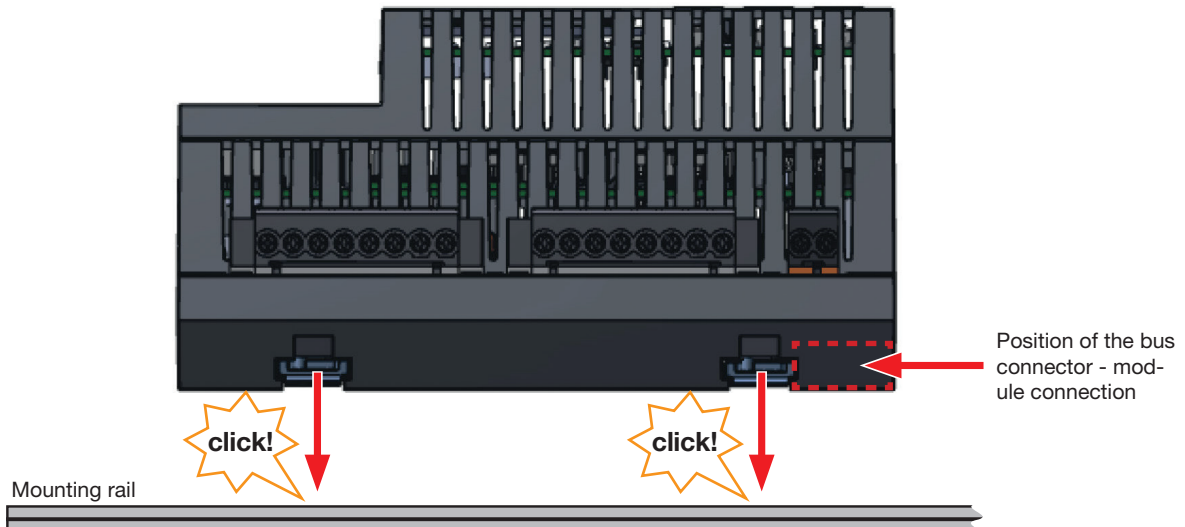

Fig. Device with bus connector on mounting rail acc. to DIN EN 60715 (for mounting rail types, see Technical Data)

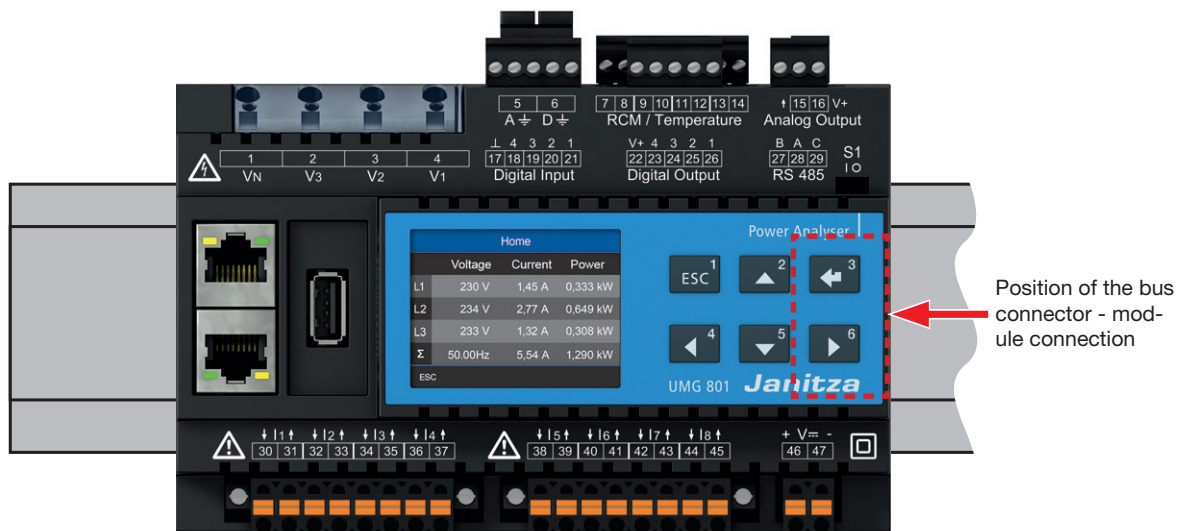

Fig.: Device on mounting rail (DIN rail) acc. to DIN EN 60715 (top view)

ATTENTION

Material damage due to disregard of the installation instructions!

Disregard of the installation instructions can damage or destroy your device.

- Provide adequate air circulation in your installation environment and, as needed, cooling when the temperatures are high.

6. Grid systems

Suitable grid systems and maximum rated voltages according to DIN EN 61010-1/A1:

Three-phase 4-conductor systems with grounded neutral conductor	
IEC	$U_{L-N} / U_{L-L}: 480 V_{LN} / 830 V_{LL}$
UL	$U_{L-N} / U_{L-L}: 347 V_{LN} / 600 V_{LL}$

Three-phase three-conductor systems with grounded phase	
IEC	$U_{L-L} 830 V_{LL}$
UL	$U_{L-L} 600 V_{LL}$

Three-phase 4-conductor systems with non-grounded neutral conductor (IT networks)	
IEC	$U_{L-L}: 690 V_{LL}$
UL	$U_{L-L}: 600 V_{LL}$

Range of application of the meter:

- 3 and 4-conductor networks (TN, TT and IT networks).
- Industrial areas.

 WARNING
<p>Risk of injury due to electrical voltage! Rated surge voltages above the permitted over-voltage category can damage the insulation in the device. This impairs the safety of the device. This can result in serious injury or death.</p> <ul style="list-style-type: none"> • Only use the device in environments which comply with the permissible rated surge voltage. • Observe the limit values specified in the user manual and on the rating plate.

Three-phase three-conductor systems ungrounded	
IEC	$U_{L-L}: 690 V_{LL}$
UL	$U_{L-L}: 600 V_{LL}$

INFORMATION

Functional earth

- **Connection D** in TN, TT and IT networks must always be connected.
- **Connection A** only connect in TN and TT networks (**not in IT networks**).

7. Installation

Use the meter for voltage measurement in TN, TT and IT networks with the approved overvoltage category of 1000 V CAT III according to IEC and 600 V CAT III according to UL (rated surge voltage 8 kV).

⚠ WARNING

Risk of injury due to electrical voltage!
Do **not** short-circuit secondary connections of voltage transformers! This can result in serious injury or death.

- **Connect voltage transformers according to their documentation!**
- **Check your installation!**

⚠ WARNING

Disregard of the connection conditions of the transformers to Janitza measurement devices or their components can lead to injuries or even death or to material damage!

- Do not use Janitza measurement devices or components for critical switching, control or protection applications (protective relays)! It is not permitted to use measured values or measurement device outputs for critical applications!
- For Janitza measurement devices and their components use **only** “Transformers for measurement purposes” which are suitable for the energy monitoring of your system. Do **not** use “Transformers for protection purposes”!
- Observe the information, regulations and limit values in the usage information on “Transformers for measuring purposes”, specifically during testing and commissioning of the Janitza measurement device, the Janitza component and your system.

7.1 Nominal voltages

7.1.1 Three-phase 4-conductor network with grounded neutral conductor

Suitable mains and nominal voltages for your meter:

U_{L-N} / U_{L-L}	
66 V / 115 V	
120 V / 208 V	
127 V / 220 V	
220 V / 380 V	
230 V / 400 V	
240 V / 415 V	
260 V / 440 V	
277 V / 480 V	
347 V / 600 V	Maximum nominal voltage of the network according to UL
400 V / 690 V	
417 V / 720 V	
480 V / 830 V	Maximum nominal voltage of the network according to IEC

Tab: Nominal network voltages suitable for measuring inputs acc. to EN 60664-1:2003

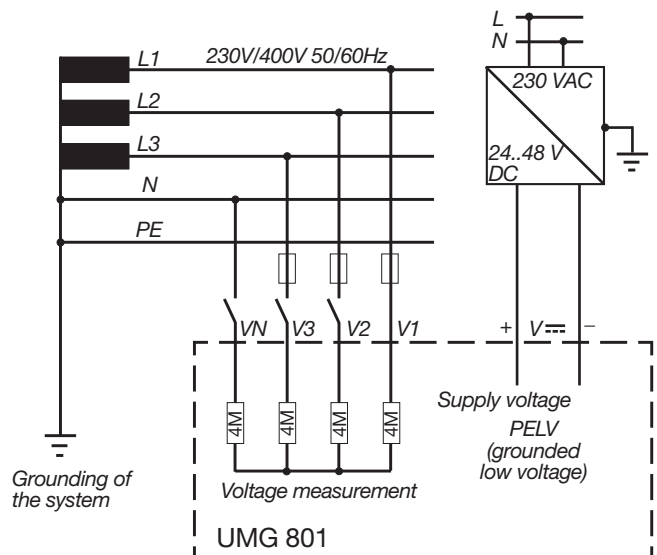

i INFORMATION

Further details on the technical data can be found in the chapter „19. Technical data“ on page 102.

7.2 Disconnect switch

When installing in a building, provide a suitable disconnect switch for the supply voltage in order to disconnect your system and thus your device from the supply of power.

- Install the disconnect switch of your system or device in such a way that it is easily accessible by the user.
- Mark the switch as an isolation device for your system or device.

7.3 Supply voltage

⚠ WARNING

Risk of injury due to electrical voltage!

Severe bodily injury or death can result from:

- Touching bare or stripped leads that are energized.
- Device inputs that pose a hazard when touched.
- Disconnect your system from the power supply before mounting and connecting the device!
- Secure it against being switched on!
- Check to be sure it is de-energized!
- Ground and short circuit!
- Cover or block off adjacent live parts!

A supply voltage is required to operate the device. The type and level of the supply voltage for your device can be found on the rating plate.

The supply voltage is connected via plug-in terminals (scope of delivery) on the front of the device.

Before applying the supply voltage, make sure that the voltage and frequency match the specifications on the rating plate.

After connecting the supply voltage, the display becomes active.

ⓘ INFORMATION

Note that the device requires an initialization phase (boot time) at startup!

If no display appears, check:

- The connection of your device.
- The supply voltage.

ⓘ INFORMATION

The fuse is a line protection - it is not a device protection!

ATTENTION

Material damage due to disregard of the connection instructions!

Disregard of the connection instructions or exceeding the permissible voltage range can damage or destroy your device.

Before connecting the device to the supply voltage, please note:

- **Voltage and frequency must correspond to the specifications on the rating plate!**
- **Comply with the limit values (see section „19. Technical data“ on page 102) as described!**
- In the building installation, secure the supply voltage with a UL/IEC listed line circuit breaker/fuse!
- Observe the following for the isolation device:
 - Install it close to the device and easily accessible for the user.
 - Mark it for the respective device.
- Do not tap the supply voltage from the voltage transformers.
- Provide a fuse for the neutral conductor if the neutral conductor terminal of the source is not grounded.

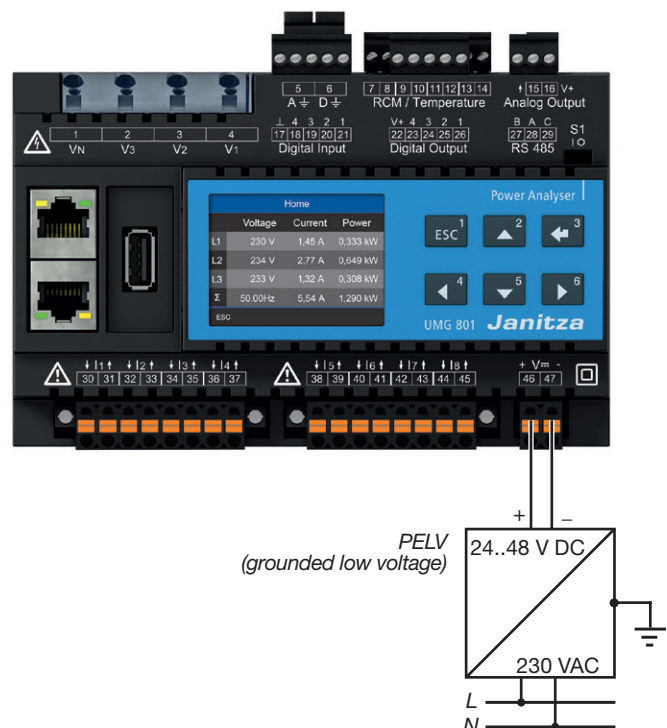

7.4 Voltage measurement

The device has 4 voltage measurement inputs and is suitable for various connection variants.

⚠ WARNING

Risk of injury or damage to the device due to electrical voltage and improper connection!
 Failure to comply with the connection conditions for the voltage measurement inputs can result in damage to the device or serious injury, including death. Therefore, please observe the following:

- **Switch off your installation before commencing work! Secure it against being switched on! Check to be sure it is de-energized! Ground and short circuit! Cover or block off adjacent live parts!**
- **Do not apply a DC voltage**
 - to the voltage measurement inputs.
 - Equip the voltage measurement inputs with a suitable, marked fuse and isolation device (alternatively: line circuit breaker) located nearby.
 - The voltage measurement inputs are dangerous to touch.
- **Connect voltages that exceed the permissible nominal network voltages via a voltage transformer.**
- **Measured voltages and currents must originate from the same network.**

ⓘ INFORMATION

As an alternative to the fuse and isolation device, you can use a line circuit breaker.

ⓘ INFORMATION

The functional earthing is a functional part and essential for the regular operation of the electrical system.

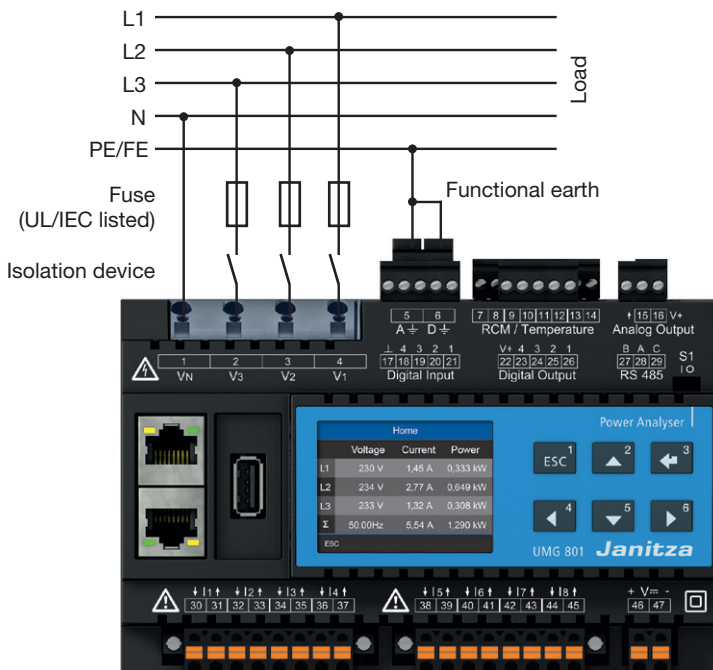

Fig. Connection example for "voltage measurement". PELV

7.4.1 Overvoltage

The voltage measurement inputs are designed for measurements in low-voltage networks in which nominal voltages occur as described in the chapter „19. Technical data“ on page 102. Information on the rated surge voltages and overvoltage categories can also be found in the technical data.

7.4.2 Mains frequency

The device:

- Requires the mains frequency for the measurement and calculation of measured values.
- Is suitable for measurement in networks in which the fundamental oscillation of the voltage is in the range from 40 Hz to 70 Hz.
- Requires a voltage L1-N of greater than $10 V_{\text{eff}}$ for the automatic determination of the mains frequency at the voltage measurement input V1.
- Calculates the sampling frequency of the voltage and current measurement inputs from the mains frequency.

INFORMATION

The device only determines measured values if a voltage L1-N of greater than $10 V_{\text{eff}}$ (4-conductor measurement) or a voltage L1-L2 of greater than $18 V_{\text{eff}}$ (3-conductor measurement) is applied to the voltage measurement input V1.

Use line protection with IEC/UL approval (1 - 10 A, tripping characteristic B) as an overcurrent protective device for the voltage measurements.

7.4.3 Connection variants for voltage measurement

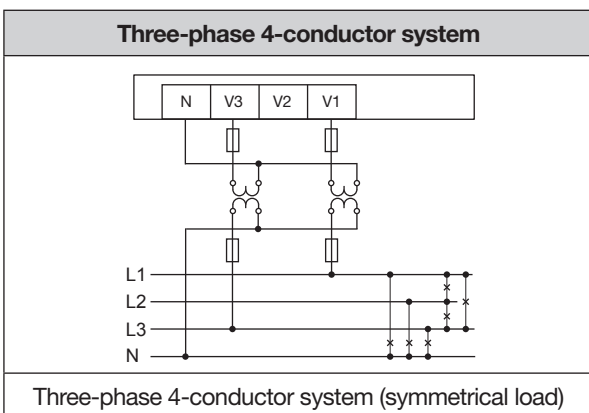
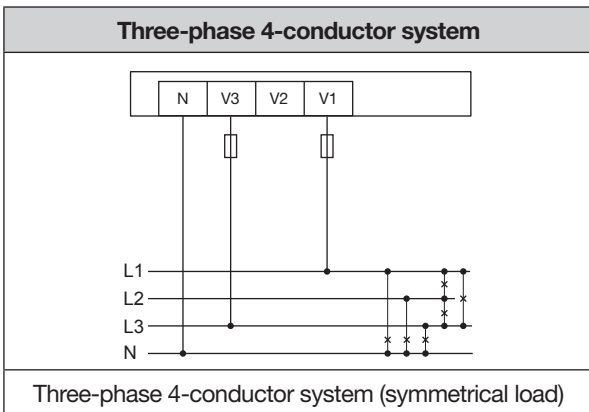
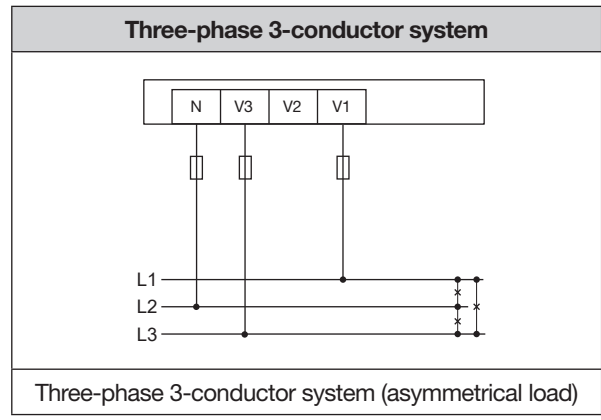
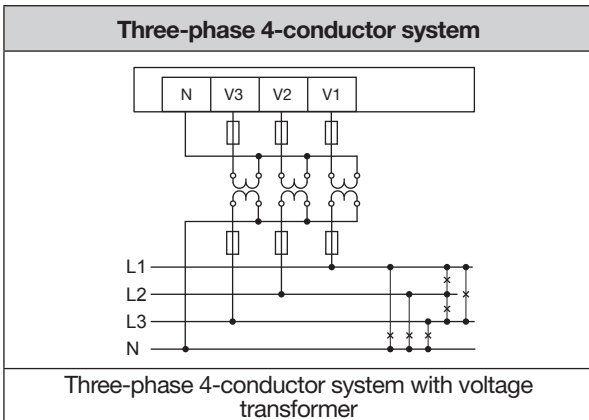
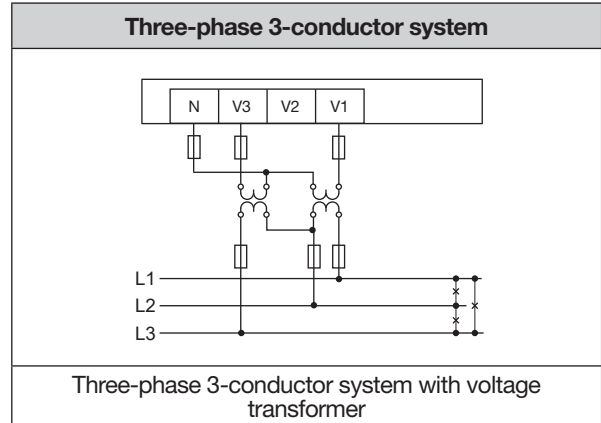
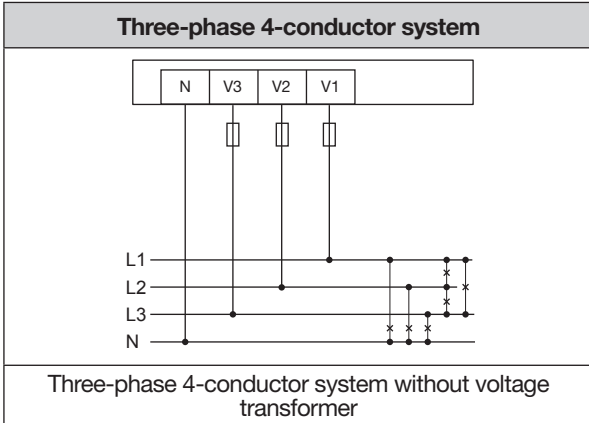

i INFORMATION

- If the measuring range is exceeded, a warning message appears in the measurement display (see section „18.1 Overrange“ on page 100).
- For a PE/N measurement, connect measuring input A as the functional earth. Do not use a green-yellow wire for this, as the conductor has no protective function!

7.5 Current measurement

The device:

- Measures current exclusively via current transformers.
- Permits the connection of current transformers with a transformer ratio of $\dots/1$ A and $\dots/5$ A for current measurement inputs I1 to I8.
- Has a current transformer ratio of 5/5A (I1 to I8) as the default setting.
- Allows mA current measurement via the multi-function channels (terminals 7 to 14) only with suitable current transformers.

The current transformers require a basic insulation according to IEC 61010-1:2010 for the nominal voltage of the circuit.

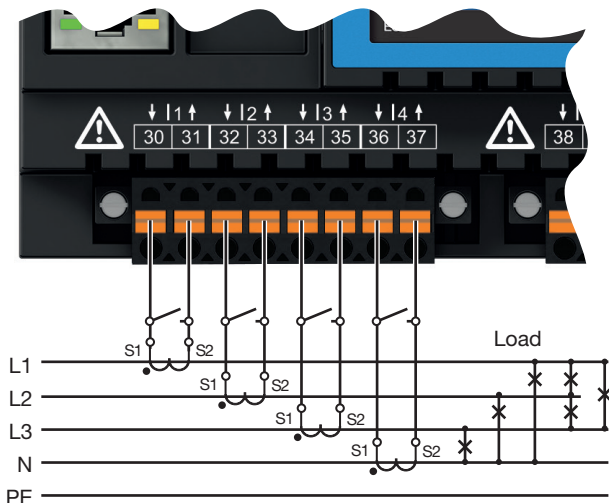

Fig. Connection example for "current measurement".

ATTENTION

Material damage due to disregard of the connection instructions during current measurement.

Failure to comply with the connection requirements of your device can result in the permissible current measurement range being exceeded. This can lead to damage or destruction of your device or your system and thus to material damage!

- **Use current transformers for current measurement! The device only allows current measurement via current transformers!**
- **Observe the connection conditions for the current measurement inputs of your device and the current transformers!**

WARNING

Risk of injury due to high currents and high electrical voltages!

Severe bodily injury or death can result from:

- Touching bare or stripped leads that are energized.
 - Dangerous live current measurement inputs of the device and at the current transformers.
- Therefore, please note for your system:
- **Disconnect the supply of power before starting work!**
 - **Secure it against being switched on!**
 - **Check to be sure it is de-energized!**
 - **Ground and short circuit! Use the ground connection points with the ground symbol for grounding!**
 - **Cover or block off adjacent live parts!**

WARNING

Risk of injury due to electrical voltage at current transformers!

Current transformers which are operated exposed on the secondary side can carry hazardous live high voltage peaks which can lead to serious bodily injury or death.

Therefore please abide by the following:

- **Switch off your installation before commencing work! Secure it against being switched on! Check to be sure it is de-energized! Ground and short circuit! Cover or block off adjacent live parts!**
- **Avoid exposed operation of the current transformers.**
- **Short-circuit unloaded current transformers.**
- **Before interrupting the current supply, short circuit the secondary connections of the current transformers.**
- **If there is a test switch which automatically short-circuits the secondary current transformer lines, it is sufficient to set it to the "Test" position, provided that the short-circuiters have been checked beforehand.**
- **Only use current transformers with basic insulation according to IEC 61010-1:2010.**
- **Fix the attached screw terminal to the device with the two screws.**
- **Even current transformers rated as safe for exposed operation are dangerous to touch if they are operated exposed.**

WARNING

Risk of injury or damage to the device due to electrical voltage and improper connection!

High measuring currents can cause temperatures of up to 80 °C (176 °F) at the connections.

Use wiring designed for an operating temperature of up to 80 °C (176 °F)!

7.5.1 Connection variants for current measurement

Current measurement I1 to I4 and I5 to I8

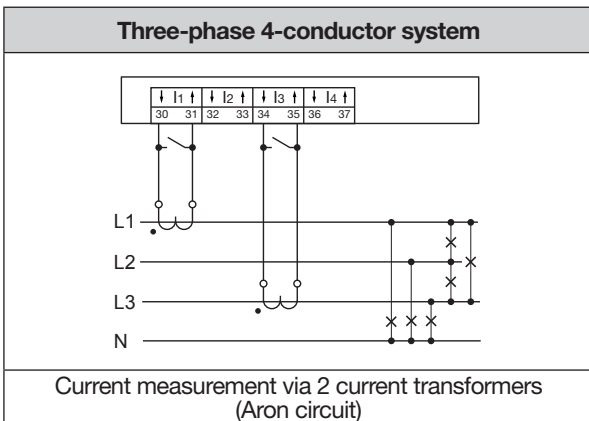
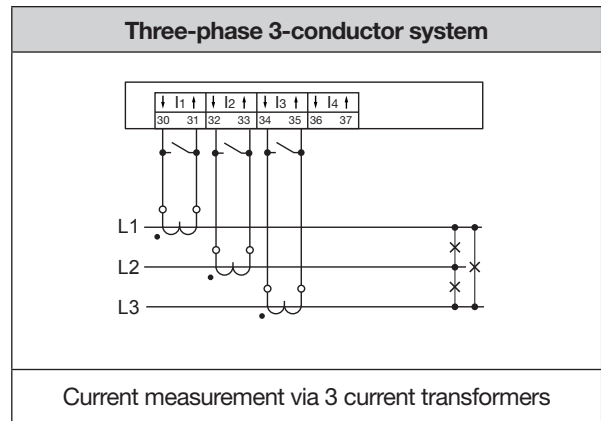
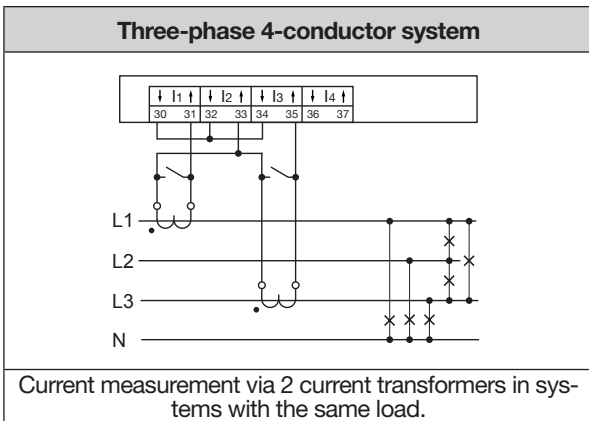
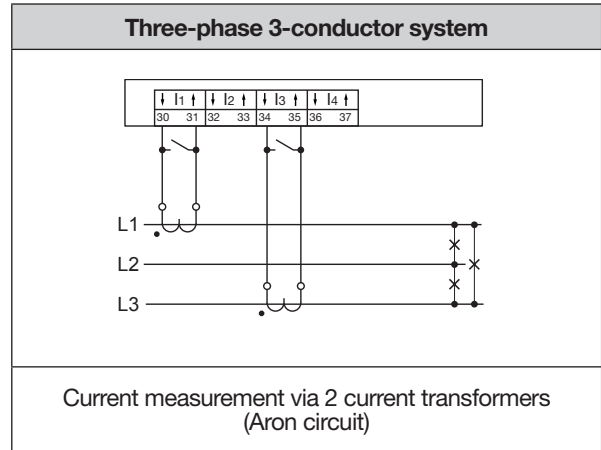
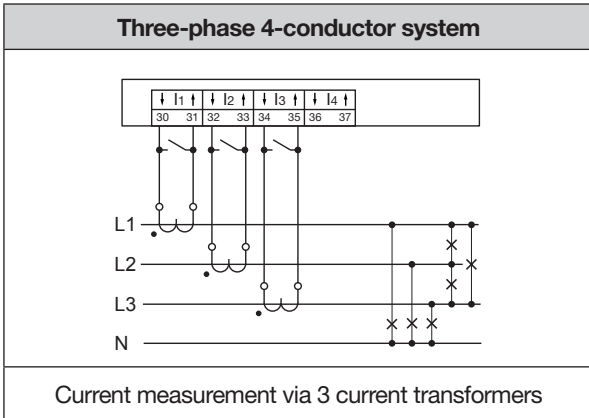

i INFORMATION

You can configure current transformer ratios conveniently via

- The device menu.
- The GridVis® software.

Information on programming the current transformer ratios can be found in section „11.4 Configuring current transformers“ on page 67.

If the measuring range is exceeded, the measurement display for the current shows a warning message indicating the phase (see section „18.1 Overrange“ on page 100).

i INFORMATION

Setting in the GridVis® software:

To activate the Aron circuit in the “Three Phase System” measurement group mode, select “Calculate” for current channel I2 (L2). This function does not exist for the “Single measurements” measurement group mode.

7.5.2 Summation current measurement

For a summation current measurement via two current transformers, first set their total ratio on the device (for setting the current transformer ratios, see section „11.4 Configuring current transformers“ on page 67).

Example:

The current is measured via two current transformers. Both current transformers have a ratio of 1000/5 A. The summation measurement is carried out with a summation current transformer of 5+5/5 A.

Set the device as follows:

Primary current: 1000 A + 1000 A = **2000 A**

Secondary current: **5A**

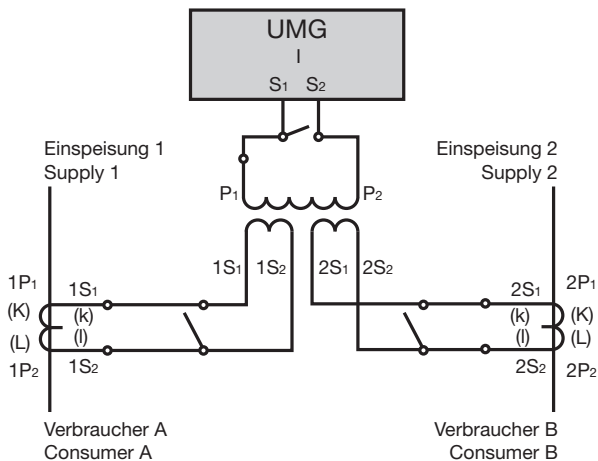

Fig. Example for current measurement via a summation current transformer.

7.5.3 Ammeter

For a current measurement with an additional ammeter, connect the ammeter in series to the UMG:

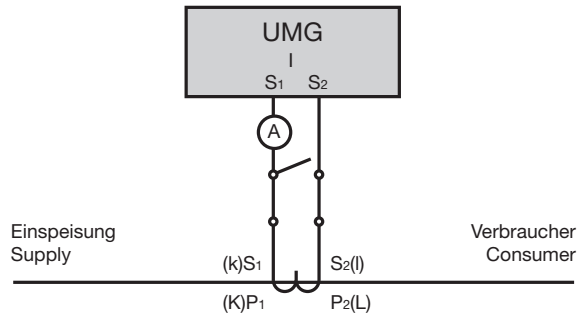

Fig. Example circuit diagram with ammeter in series connection

7.6 Multifunction channels

The terminal pairs 7/8, 9/10, 11/12 and 13/14 optionally serve as connections (4 channels) for the following measurements:

1. Residual current measurement (RCM).
2. Temperature measurement.
3. Measurement of further current channels (mA range) via suitable current transformers.

i INFORMATION

Configure the function of the respective connection, residual current or temperature measurement, in the GridVis® software.

To connect the multifunction channels, select from the options residual current measurement, temperature measurement, mA current measurement or a combination of these measurements.

Please note:

After changing the measurement of the multifunction channels (e.g. configuration of channel 7/8 from residual current measurement to temperature measurement), restart your device (in the menu: Configuration -> Reset -> Restart)!

With a restart, the device re-initializes the multifunction channels and the respective Modbus profile contains the corresponding measured values.

7.7 Residual current measurement (RCM)

The measurement device is suitable as a residual current monitoring device (RCM) for monitoring alternating currents, pulsating direct currents and direct currents.

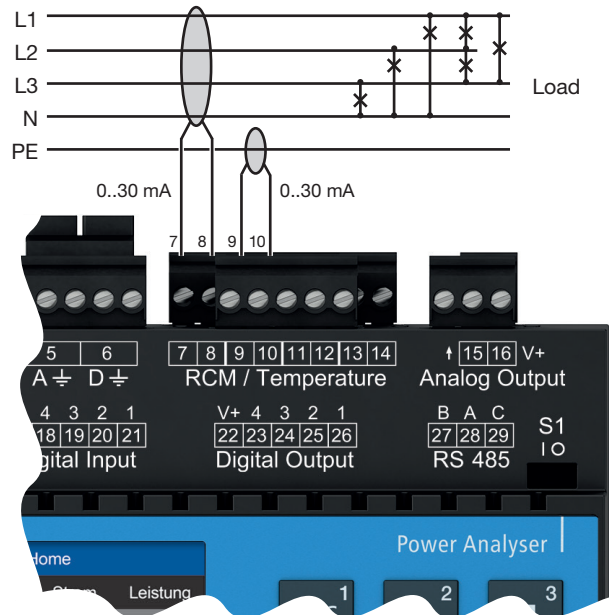



Fig. Connection example "Variant, residual current measurement" via current transformer (Type A).

The meter measures residual currents according to IEC/TR 60755 (2008-01) of:

-  Type A
-  Type B and type B+
(via corresponding current transformers)

Residual current transformers with a nominal current as given in chapter „19. Technical data“ on page 102 are suitable for the meter’s residual current measurement function.

ATTENTION**Faulty cross currents, incorrect measurements, and even damage to the device and/or your system due to lack of galvanic isolation!**

A lack of galvanic isolation of active external current transformers (or other current sensors) on the multifunction channels from the supply voltage of the device can lead to faulty cross currents, incorrect measurements or even damage to your device and/or system.

- Do not take the auxiliary voltage supply of active external current transformers (or other current sensors) on the multifunction channels from the supply voltage of the device! For each active current transformer, use galvanically isolated power supplies (secondary side).
- Do not ground passive current transformers on the multifunction channels! Observe the usage information of the current transformer manufacturer.

Monitoring residual currents in an electrical system via the residual current inputs of the device (terminals 7/8, 9/10, 11/12 and 13/14) allows an alarm management system to be set up with the GridVis® software. This allows the system operator to be alerted before a protective device is triggered.

The measurements in medium and high voltage networks are made via current and voltage transformers.

i INFORMATION

Limit values for warnings and alarms, e.g. for the device or system operator, can be conveniently configured in the GridVis software®. In the GridVis® software, you also configure the ratios of the residual current transformers separately for each residual current input.

i INFORMATION

The meter is not an independent protective device against electric shock!

7.7.1 Current direction of the residual current transformers

For residual current measurement with current transformers in AC operation at the measuring inputs, the device does not distinguish between the current directions. Incorrect connection of the residual current transformers in AC operation does not require subsequent rewiring.

i INFORMATION**AC operation:**

The meter does not distinguish between the current directions of the residual currents.

The residual currents of the grid side or load side are **not** directionally sensitive.

AC/DC operation:

Pay attention to the polarity when using current transformers in AC/DC operation!

See section „7.7.4 Connection examples - Residual current measurement“ on page 43.

⚠ WARNING**Risk of injury due to large currents and high electrical voltage on the current transformers!**

Current transformers operated while open on the secondary side (high voltage peaks pose a hazard when touched) can result in severe bodily injury or death.

- **Avoid operating the current transformers while open; short circuit the unloaded transformers!**
- **Before interrupting the current supply, short circuit the secondary connections of the current transformers. Switch any test switches that automatically short circuit the secondary lines of the current transformers to the “Test” status (Check the test switch/short circuiting connection beforehand)!**
- **Only use current transformers with basic insulation to IEC 61010-1:2010!**
- **Caution, even current transformers rated as safe for open operation can pose a hazard when touched during operation while open!**
- **Make sure that screw terminals for the current transformer connection on the device are adequately tightened!**
- **Comply with the information and provisions in the documentation of your current transformers!**
- **Ground connections present on the secondary windings of the current transformers must be connected to ground!**
- **Observe the general safety information for handling current transformers and devices with residual current measurement.**

7.7.2 Residual current transformer example

Operating equipment must have reinforced or double insulation from supply circuits!

Example:

A residual current transformer is used to measure on insulated mains wiring in a 300 V CAT III network.

Solution:

Provide basic insulation for 300 V CAT III for the insulation of the network wiring and the insulation of the residual current transformer. This corresponds to a test voltage of 1500 V AC (1 min. duration) for the insulated network wiring and a test voltage of 1500 V AC (1 min. duration) for the residual current transformer.

7.7.3 Important information about the residual current measuring inputs



CAUTION

Risk of injury or damage to the meter/your system due to short circuit!

Inadequate insulation of the operating equipment at the residual current measuring input with respect to the supply circuits can cause voltages at the measuring input which represent a hazard when touched or damage to your device or system.

- **Ensure reinforced or double insulation with respect to the supply circuits.**
- **Isolate residual current measuring inputs galvanically from each other and galvanically from the supply voltage (24 V)!**

INFORMATION

Ratios for the residual current transformer inputs can be configured individually on the meter or via the GridVis® network visualization software.

7.7.4 Connection examples - Residual current measurement

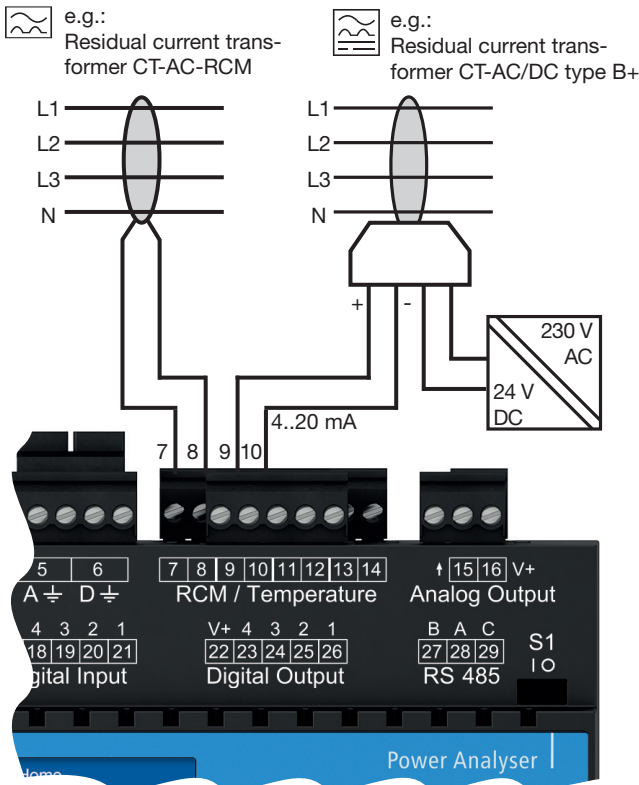

⚠ CAUTION

Risk of injury or damage to the meter/your system due to short circuit!

Inadequate insulation of the operating equipment at the residual current measuring input with respect to the supply circuits can cause voltages at the measuring input which represent a hazard when touched or damage to your device or system.

- **Ensure reinforced or double insulation with respect to the supply circuits!**
- **Isolate residual current measuring inputs galvanically from each other and galvanically from the supply voltage (24 V)!**

Fig. Connection variant, residual current measurement via current transformer Type A and Type B. (Power supply with $U = 24\text{ V DC}$, residual ripple $< 5\%$, output = 24 W).

ⓘ INFORMATION

Pay attention to the polarity when using type CT-AC/DC current transformers!

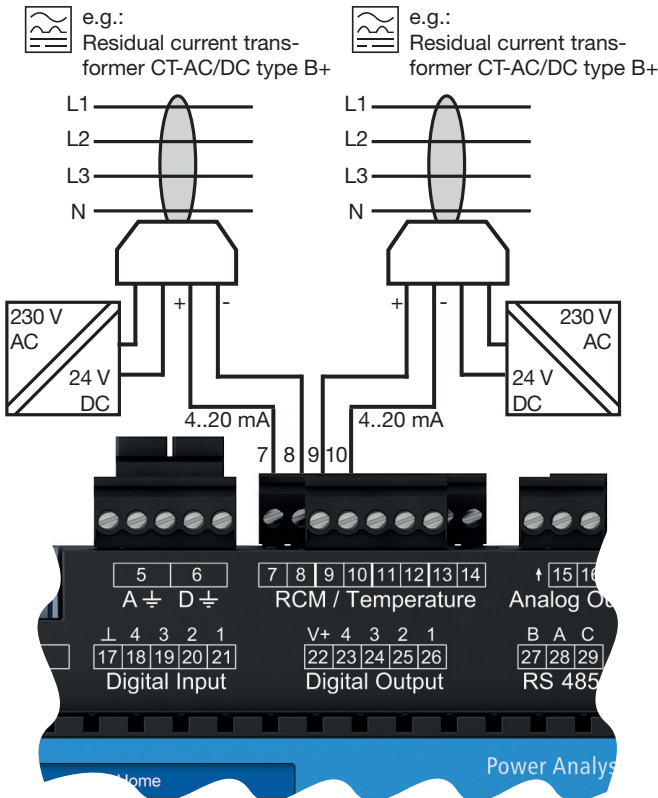

Fig. Connection variant, residual current measurement via current transformer of Type B. Each residual current transformer of the series CT-AC/DC type B+ RCM requires its own power supply (with $U = 24\text{ V DC}$, residual ripple $< 5\%$, power = 24 W).

ⓘ INFORMATION

Galvanically insulate the secondary sides of the power supplies (24 V DC) from each other!

7.7.5 Connection example - Residual current monitoring

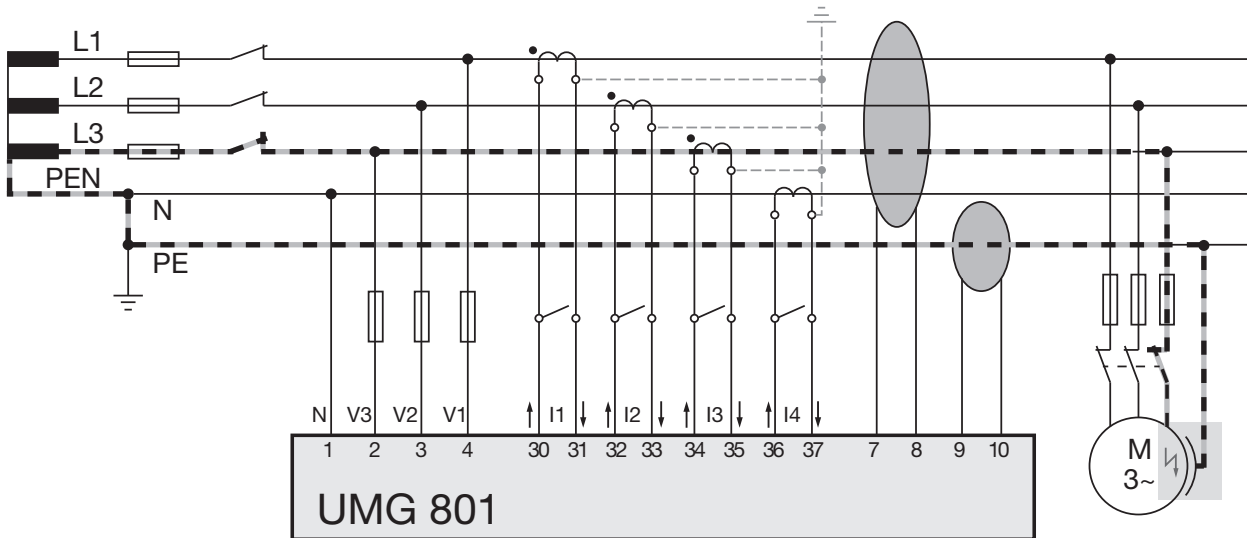

Fig. Connection example UMG 801 with residual current monitoring via 2 multifunction channels (7/8, 9/10) as measuring inputs for the residual currents.

⚠ CAUTION

Risk of injury or damage to the meter/your system due to short circuit!

Inadequate insulation of the operating equipment at the residual current measuring input with respect to the supply circuits can cause voltages at the measuring input which represent a hazard when touched or damage to your device or system.

- **Ensure reinforced or double insulation with respect to the supply circuits!**
- **Isolate residual current measuring inputs galvanically from each other and galvanically from the supply voltage (24 V)!**

7.8 Residual current measurement - limit value calculation

To set and calculate residual current limit values, the device requires parameters that you can set in the **GridVis® software**.

A reference value for the residual current limit value calculation can be applied not only to the current channels and groups of the basic device but also to connected current measuring modules, and it can be configured in the GridVis® software.

The residual current measurement of the UMG 801 and the current measuring modules has 3 types of limit value calculation:

1. Static limit value calculation

A constant limit value is defined. If this limit value is exceeded, a limit violation occurs.

2. Dynamic limit value calculation

In dependence on a reference value, the limit value for violations changes continuously and with it the respective warning.

The respective limit value is calculated from the reference value multiplied by a scaling factor, plus a static offset.

3. Stepwise limit value calculation

In dependence on a reference value, the limit value for violations changes step by step and with it the respective warning. Individual limit values can be defined for up to 10 ascending thresholds of the reference value (power levels). The respective limit values are calculated from the static offset plus the threshold offset of the highest threshold value exceeded by the reference value.

7.8.1 Static limit value calculation

Required parameters:

- Static residual current limit value.
- Minimum time for which the residual current limit value is exceeded (RCM alarm).
- Warning before the static residual current limit value is reached (warning level in %).

$$\text{Residual current limit value} \times \text{warning level} = \text{warning limit value}$$

Percentage value of the residual current limit value

Example graph

The following example graph explains the residual current measurement with a static limit value calculation:

- Residual current limit value: 300 mA.
- Warning level (in %)

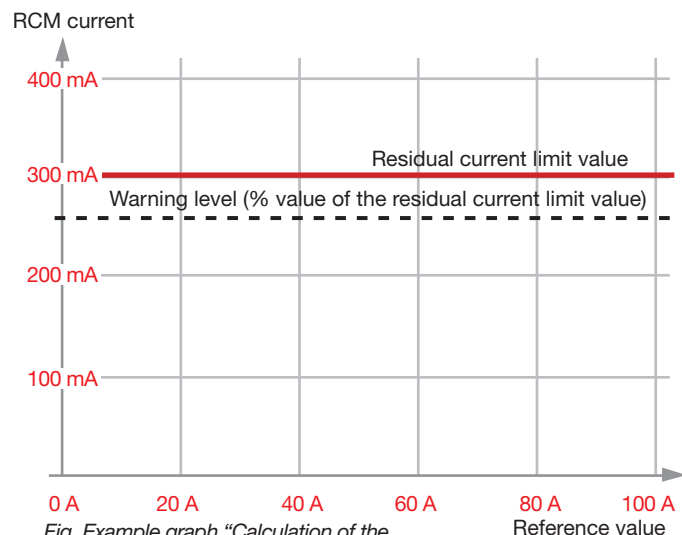

Fig. Example graph "Calculation of the static residual current limit value".

Explanation:

- The static limit value calculation (constant value) is active.
- If a **measured residual current** exceeds the warning level, the device displays a warning.
- If a **measured residual current** exceeds the residual current limit value, the device indicates an overcurrent violation.
- If the **measured residual current** exceeds the residual current limit value for longer than the **minimum exceedance time** (configurable in the GridVis® software), the device triggers an alarm.

7.8.2 Dynamic limit value calculation

Required parameters:

- Minimum time for which the residual current limit value is exceeded (RCM alarm).
- Warning level (percentage value, warning before the limit value is reached).
- Reference value - measured value (selectable from the multifunction channels, the current channels of the basic device or the modules).
- Tolerated residual current (dynamic limit value component in relation to the reference value).
- Offset (static component) of the limit value.

Dynamic limit value

- Is a function of a reference value (measured value).
 - Adjusts the limit value for violations dynamically.
- The dynamic limit value is calculated from:

$$\text{Reference value} \times \text{scaling factor} + \text{offset} = \text{dynamic limit value}$$

Measured value Scaling as a reference to the RCM current Static offset

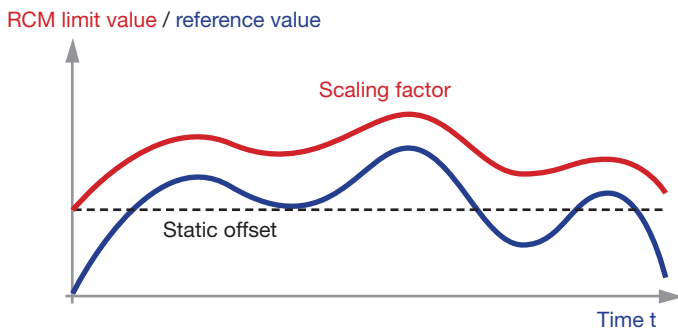

Warning limit value

The dynamic warning limit value is therefore calculated using the following formula:

$$\text{Warning level} \times (\text{reference value} \times \text{scaling factor} + \text{offset}) = \text{Warning limit value}$$

% value

Dynamic limit value calculated by the measurement device

Example graph

The example graph for the dynamic limit value shows the relationship between the residual current limit value and the reference value (e.g. "power") with the following settings:

- Reference value: Power in kW
- Scaling: 10 mA / kW
- Offset for residual current measurement: 20 mA

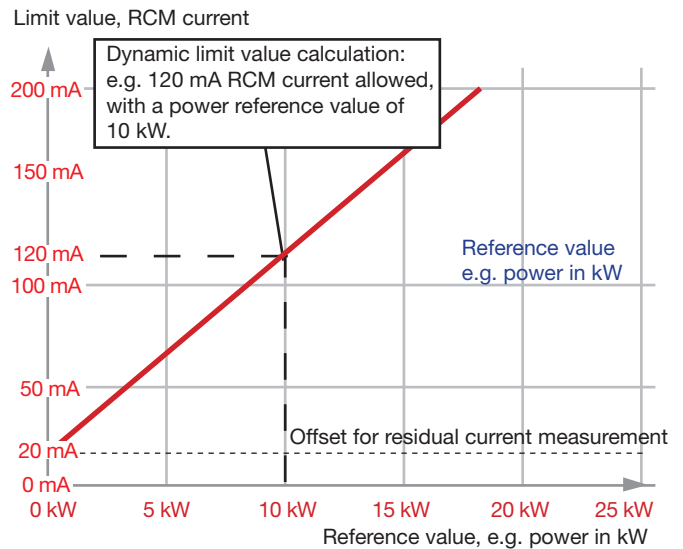

Fig. Example graph, "Calculation of the dynamic residual current limit value".

7.8.3 Stepwise limit value calculation

Required parameters:

- Reference value (e.g. power in kW).
- Minimum time for which the residual current limit value is exceeded (RCM alarm).
- Warning level (percentage value, warning before the limit value is reached).
- Input of residual current limit values for the respective power levels (steps).
- Offset (static component) of the limit value.

Stepwise limit value

- Is a function of a reference value.
- Adjusts the residual current limit value stepwise in accordance with the power levels and the associated limit value offsets.
- Is calculated from a static offset and the respective limit value offset (the highest threshold value exceeded by the reference value).
- If no power level is configured, the static offset applies.

Example graph

The example graph shows the stepwise increase of the residual current limit values as a function of the reference value “power” (of the system) with the following power levels (steps):

- Reference value: Power in kW.
- Variable residual current limit value per power level.

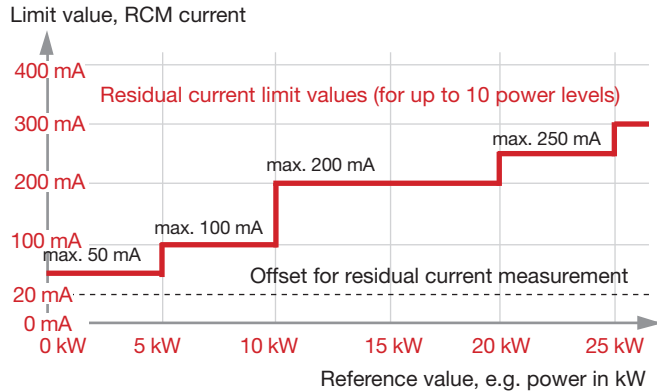
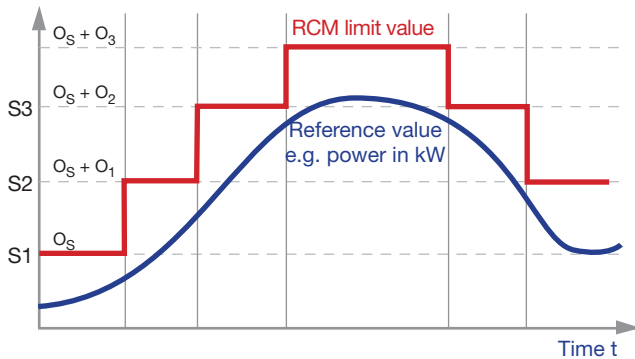

Fig. Example graph, “Calculation of the stepwise residual current limit value”

RCM limit value / reference value



Abbreviation	Description
S1, S2, S3	Thresholds of the stepwise residual current limit values
O _S	Static offset
O ₁ , O ₂ , O ₃	Limit value offsets assigned to the residual current thresholds

i INFORMATION

This limit value calculation allows a non-linear configuration of the levels. These non-linear levels make it possible, for example, to configure a lower limit value for higher reference values. Thus, for example, machines with a comparatively low residual current at high power can be configured optimally.

7.8.4 Example: Residual current limit value exceeded

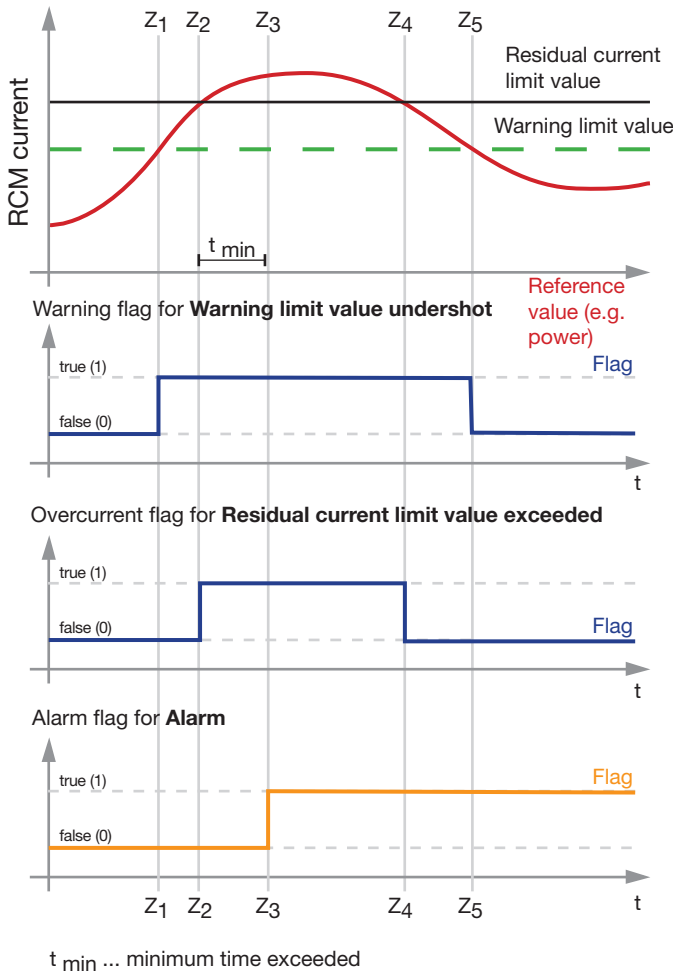

The adjacent graphs explain the 3 events **Warning limit exceeded**, **Residual current limit value exceeded** and **Alarm flag** with the states:

- Warning limit exceeded at time Z₁: Warning flag (=1).
- Residual current limit exceeded at time Z₂: Overcurrent flag (=1).
- Residual current limit value exceeded beyond the **minimum duration of exceedance** t_{min} at time Z₃: Alarm flag (=1).
- Residual current limit value undershot at time Z₄: The device sets the overcurrent flag (=0).
- Warning limit value undershot at time Z₅: The device sets the warning flag (=0).
- The alarm flag remains set until manual acknowledgment.

i INFORMATION

- The device has an alarm lead time which is used to ensure that the device does **not** trigger an alarm in the case of minor (short) violations of the residual current limit value.
- Limit values for alarms and warnings, e.g. for the device or system operator, can be conveniently configured in the **GridVis**® software.

7.8.5 Activating cable break detection (failure monitoring) RCM for the multifunction channels.

The device has a “cable break detection” (failure monitoring) function via the **GridVis® /OPC-UA** software. In this case, the device checks the connections to the residual current transformers at the measuring inputs (multifunction channels).

The cable break detection (failure monitoring) function can be activated in the **GridVis®** software.

INFORMATION

The cable break detection to monitor the current transformer connections only works with passive current transformers (AC) and current transformers with a 4-20 mA secondary output.

7.9 Temperature measurement

As already described in section “7.6 Residual current measurement (RCM)” on page 40, the terminal pairs 7/8, 9/10, 11/12 and 13/14 optionally serve as connections for temperature measurement.

The measured values of the connections declared as temperature inputs are obtained by determining the average value from accumulated resistance values. The meter calculates the temperature value from the average value.

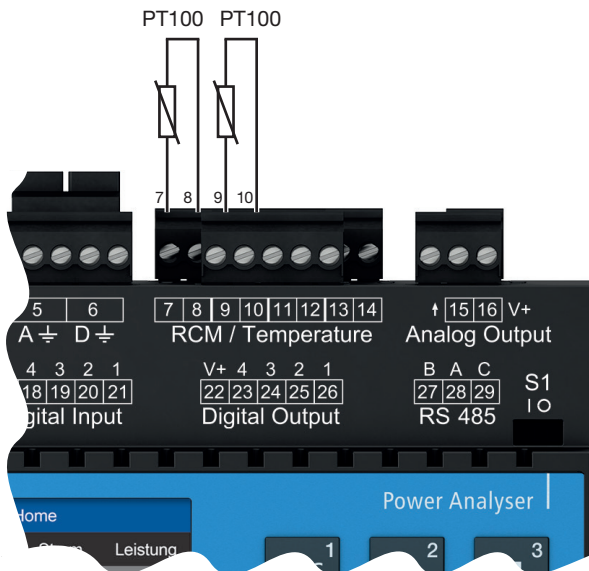

Fig. Connection example “2x temperature measurement” via PT100.

The following temperature sensors are suitable for temperature measurements:

- KTY83
- KTY84
- PT100
- PT1000

ATTENTION

Damage to the meter and/or your system due to a short circuit!

Inadequate insulation of the operating equipment (e.g. the temperature sensor) at the temperature measuring inputs with respect to the supply circuits can cause damage to your meter and/or your system.

- **Ensure a reinforced or double insulation of your operating equipment with respect to the supply circuits!**
- **Use shielded lines to connect the temperature sensor!**
- **Do not exceed a total load of 4 k Ω (temperature sensor and cable)!**

Example of temperature sensor:

A temperature sensor is to measure near uninsulated power lines in a 300 V CAT III network.

Solution:

Use reinforced or doubled insulation for the temperature sensor for the 300V CAT III network! This corresponds to a test voltage of 3000 V AC (1 min. duration) for the temperature sensor.

8. PC connection

8.1 Connection to a PC

The most common connection methods for communication of the device with a PC (with GridVis® software installed) are described below.

1. Connection to a DHCP server and PC. The DHCP server automatically assigns IP addresses to the device and the PC.

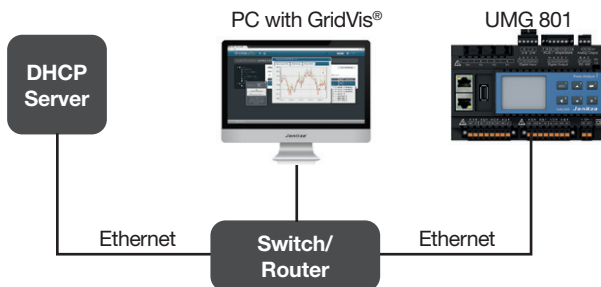

2. Connection as master device with an RS-485 bus structure to a PC and OPC UA client.

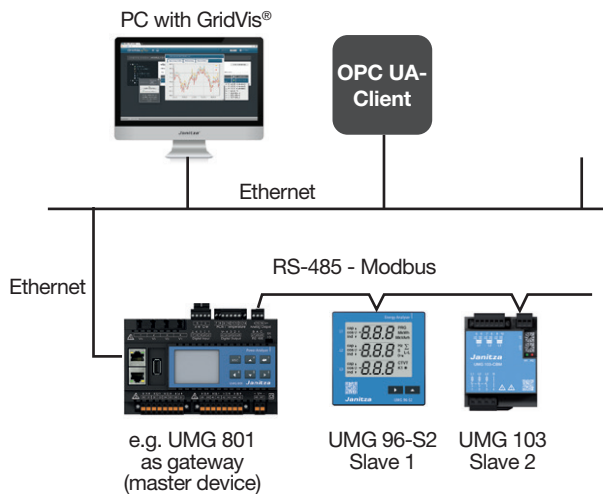

3. PC direct connection to the device. PC and device require a fixed IP address.

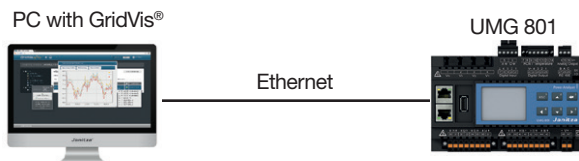

ATTENTION

Material damage due to security vulnerabilities in programs, IT networks and protocols.

Security vulnerabilities can lead to data misuse and faults and even the standstill of your IT infrastructure.

To protect your IT system, network, data communications and measurement devices:

- Inform your network administrator and/or IT representative.
- Always keep the meter firmware up to date and protect the communication to the meter with an external firewall. Close unused ports.
- Take protective measures against viruses and cyber attacks from the Internet, e.g. through firewall solutions, security updates and virus protection programs.
- Close security vulnerabilities and update or renew existing protection for your IT infrastructure.

ATTENTION

Material damage due to incorrect network settings.

Incorrect network settings can cause faults in the IT network!

Consult your network administrator for the correct network settings for your device.

9. Peripherals

9.1 Ethernet interface

The device has 2 Ethernet interfaces (Ethernet A and B). The two Ethernet interfaces:

- Are connected in series with each other (a daisy-chain connection can thus be realized).
- Communicate via **one** IP address.

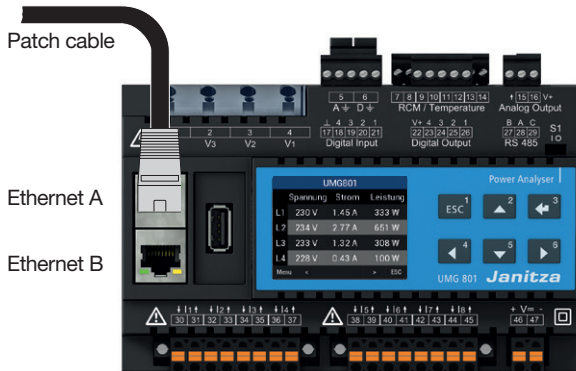

Recommendation:
Use at least CAT5 cable!

ATTENTION

Material damage due to incorrect network settings.

Incorrect network settings can cause faults in the IT network!

Consult your network administrator for the correct network settings for your device.

9.2 Daisy chain connection

With this type of connection, several devices (hardware components) are connected with each other in series. With the two Ethernet interfaces of the UMG 801, the daisy-chain connection can be implemented as follows:

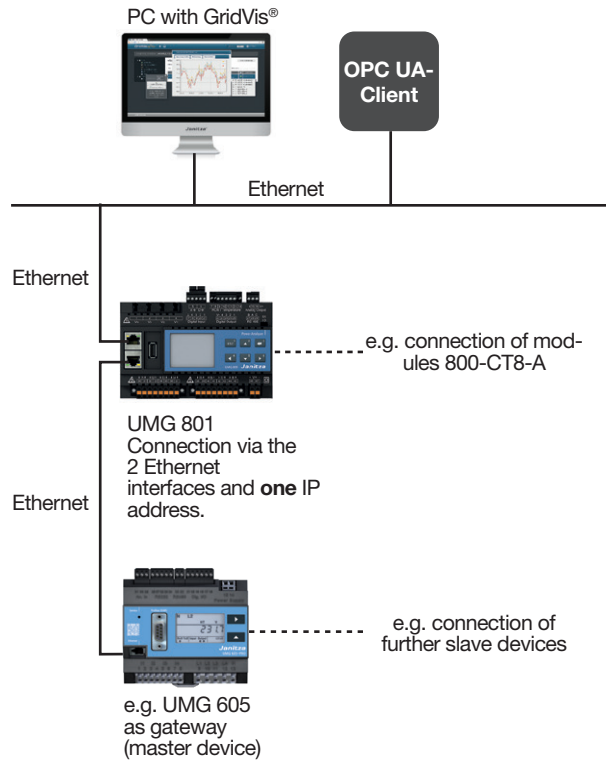

Fig.: UMG 801 in a daisy chain connection

ⓘ INFORMATION

In this figure, the daisy-chain connection exists only if:

- The supply voltage is present at the UMG 801.
- The UMG 801 has been started up.

Also note the connection interruptions during restarts!

9.3 RS-485 interface (serial interface)

The RS-485 interface of this device is designed as a 3-pole plug contact and communicates using the Modbus RTU protocol.

For the connection capacity of the terminals, see chapter „19. Technical data“ on page 102.

Examples of RS-485 interface - UMG 801

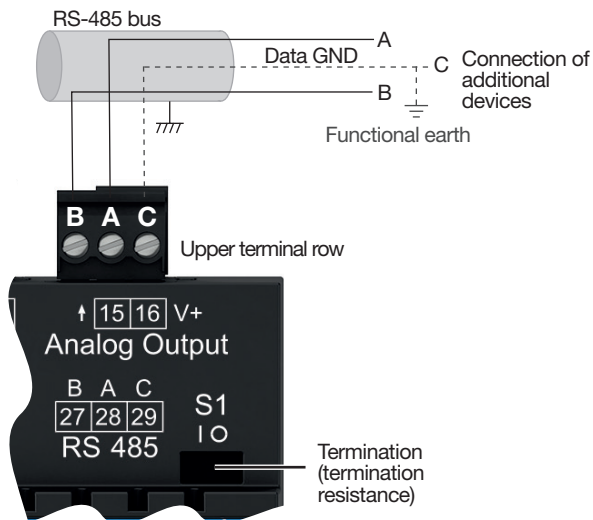

Fig. Example:
RS-485 interface of the UMG 801 (at the beginning of a bus topology - 3-pole plug contact).

RS-485 interface - UMG 801:

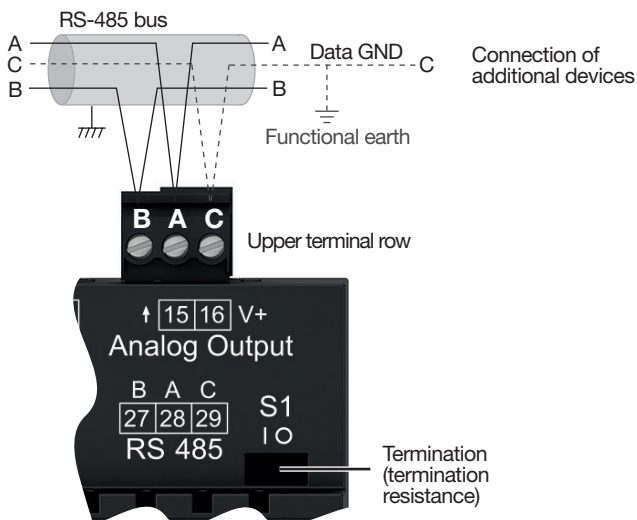

Illustration example:
RS-485 interface of the UMG 801 (in the middle of a bus topology - 3-pole plug contact).

i INFORMATION

- The device contains an integrated termination resistor (switch S1). For a UMG 801 at the beginning or end of a bus segment, terminate the device via the switch S1 - S1 to switch position "I" (on). See section „9.3.2 Termination resistors/Termination“ on page 54.
- CAT cables are not suitable for bus wiring!
Recommendation: Use Unitronic Li2YCY(TP) 2x2x0.22 (Lapp cable) for bus wiring.
- A segment of an RS-485 bus structure can contain up to 32 nodes/devices. If there are more than 32 nodes/devices, use repeaters to connect segments.
- To prevent the addition of leakage currents when using several devices, install the Data GND as the functional earth (see adjacent figures)!

9.3.1 Shielding

For connections via the interfaces, use a twisted and shielded cable and observe the following for the shielding:

- Ground the shields of all cables leading into the switchboard cabinet at the cabinet entrance.
- Route the cables into the switchboard cabinet through suitable cable inlets, e.g. PG glands.
- Connect the shield to a noiseless ground and ensure a large surface area with good conductivity.
- Do **NOT** connect the shield to terminal C (GND).
- Mechanically restrain the cables before the grounding clamp to prevent damage from cable movement (strain relief).

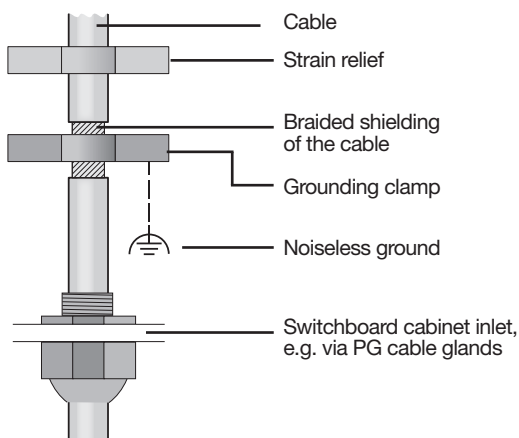
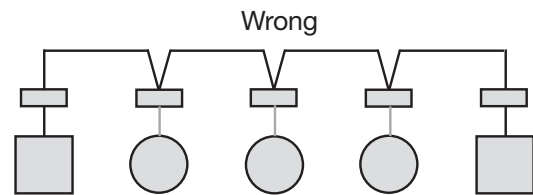
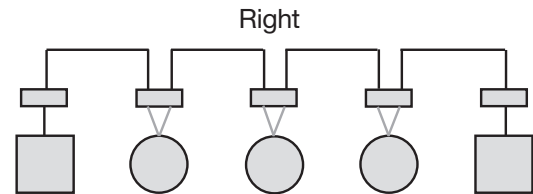

Fig. Shielding design at entrance to switchboard cabinet.

9.3.2 Termination resistors/Termination

The device contains an integrated termination resistor (S1). Terminate the beginning and the end of your bus segments with termination resistors (switch S1 of the UMG 801 = "I" or with termination resistor 120 Ω/0.25 W - see chapter „9.3.3 Bus structure (bus segment)“ on page 55).



- Terminal strip (switchboard cabinet).
- Device with RS-485 interface (Without termination resistor).
- Device with RS-485 interface (Termination resistor on the device).

WARNING

Risk of injury due to high currents and high electrical voltages!

Atmospheric discharge can cause transmission errors and dangerous voltages on the device.

Therefore please abide by the following:

- **Connect the cable shielding to functional earth (PE) at least once.**
- **For larger sources of interference or frequency converters in the switchboard cabinet, connect the shielding to functional earth (PE) as close to the device as possible.**
- **Comply with the maximum cable length of 1,200 m at a baud rate of 38.4 kbps.**
- **Use shielded cables.**
- **Route interface cables spatially separated or additionally insulated from mains voltage-carrying system components.**

9.3.3 Bus structure (bus segment)

In a bus structure:

- Connect all devices in line.
- Each device has its own device address.
- You can integrate up to 32 devices (nodes).
Terminate the beginning and the end of your bus segment with termination resistors (inside the devices or with 120 Ω /0.25 W termination resistors).
- Use repeaters (signal amplifiers) to connect bus segments if there are more than 32 nodes.
- Devices with bus termination switched on must be powered.

- It is recommended that the master be placed at the end of a segment. If the master is replaced with the bus termination switched on, the bus is out of operation.
- The bus can become unstable if a slave with bus termination switched on is replaced or is de-energized.
- Devices that are not involved in the bus termination can be replaced without the bus becoming unstable.

Fig. Representation of a bus structure

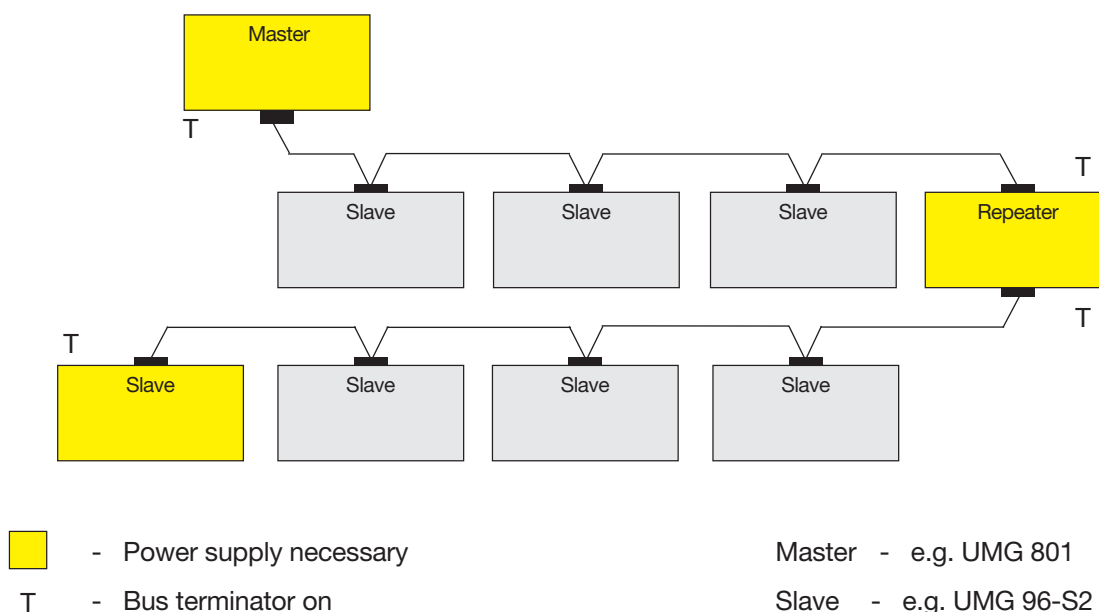

9.4 JanBus interface

The JanBus interface:

- Is a (proprietary) interface which serves to connect the UMG 801 to modules (e.g. the 800-CT8-A current measurement module).
- Is located on the underside of the meter and supplies connected modules with power.

i INFORMATION

- The maximum bus length of the JanBus is 100 m.
- Information on connecting modules can be found in the information products for the modules.

9.5 Digital inputs

The device has 4 digital inputs.

The device recognizes an input signal at the digital input if:

- A voltage of at least 18 V and at most 28 V DC (typically at 4 mA) is present.
- A current of at least 0.5 mA and at most 6 mA flows.

For voltages from 0 to 5 V and currents less than 0.5 mA there is no input signal.

i INFORMATION

Observe the polarity of the supply voltage!

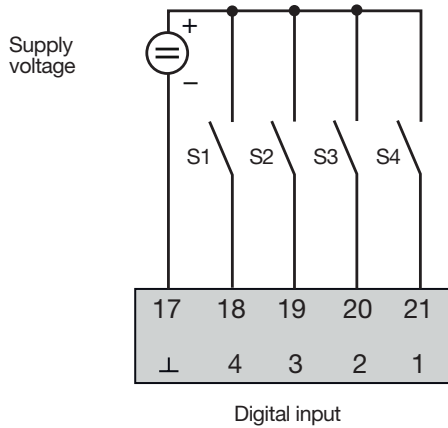

ATTENTION

Transmission error and material damage due to electrical malfunction.

With a cable length of more than 30 m, there is an increased probability of transmission errors and damage to the device due to atmospheric discharge!

Use shielded cables for the connections to the digital inputs and outputs!

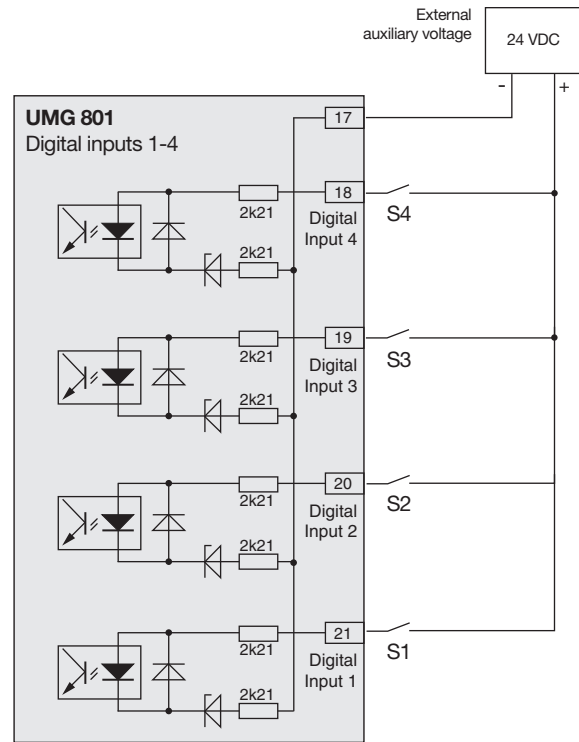

Fig. Example for the connection of external switching contacts S1 - S4 to digital inputs 1, 2, 3 and 4.

i INFORMATION

For more information on configuring the digital inputs, see section „12. Digital inputs and outputs“ on page 74

Functions for the digital inputs can be configured easily and clearly in the GridVis® software (see www.janitza.de).

S0 - Pulse input

Each digital input is designed for the connection of an S0 pulse generator according to DIN EN 62053-31. You need an external auxiliary voltage with an output voltage in the range of 18 .. 28 V DC and a resistor of 1.5 kOhm.

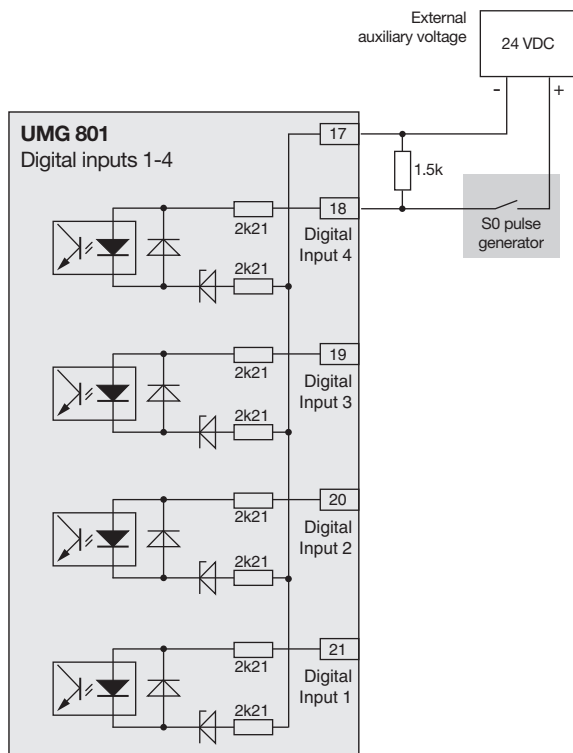

Fig. Example for the connection of an S0 pulse generator to digital input 1.

9.6 Digital outputs

The device has 4 digital outputs, which:

- Are electrically isolated from the evaluation electronics via optocouplers.
- Have a common reference.
- Are not short-circuit proof.
- Require an external auxiliary voltage.
- Can be used as pulse outputs to count energy consumption.
- Can switch DC and AC loads via relays or semiconductor electronics.
- Can be controlled via Modbus.

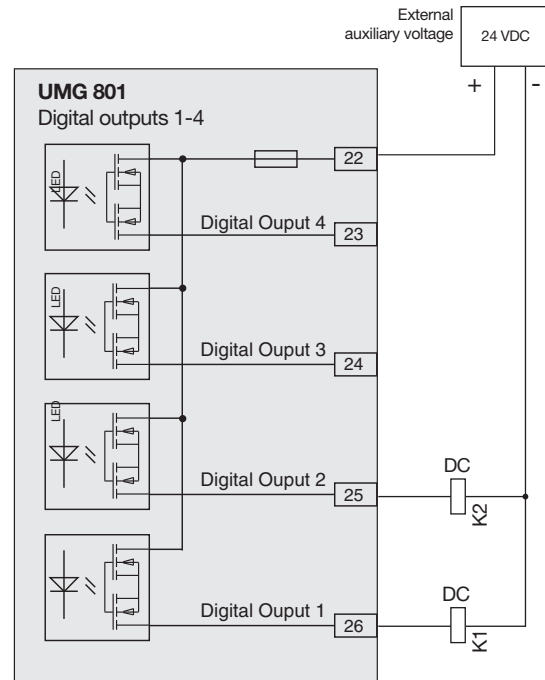
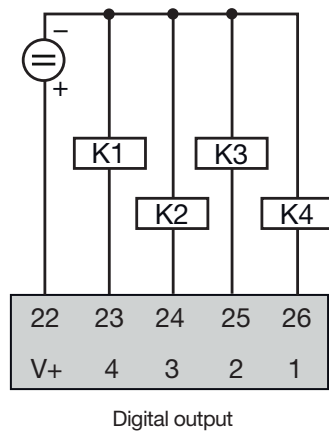

Fig. Connection example of two relays to the digital outputs

ATTENTION

Connection errors can damage the device and cause material damage.
 The digital outputs are not short-circuit proof! Connection errors can therefore lead to damage to the connections.
Make sure that the wiring is correct when connecting the outputs.

ATTENTION

Transmission error and material damage due to electrical malfunction.
 With a cable length of more than 30 m, there is an increased probability of transmission errors and damage to the device due to atmospheric discharge!
Use shielded cables for the connections to the digital inputs and outputs!

i INFORMATION

- For more information on configuring the digital outputs, see section „12. Digital inputs and outputs“ on page 74.
- Functions for the digital outputs can be configured easily and clearly in the GridVis® software (see www.janitza.de).
- To use the GridVis software®, your device requires a connection (interface) to a PC.
- When using the digital outputs as pulse outputs, measurement errors can occur due to residual ripple. For the supply voltage (DC) of the digital inputs and outputs, use power supplies whose residual ripple is less than 5% of the supply voltage.

9.7 Analog outputs

The device has a passive analog output which can output a current of 0 - 20 mA or 4 - 20 mA. An external power supply unit (24 V DC) is required for operation.

The connectable load must not exceed a resistance of 300 ohms. With larger resistors, the device limits the output range of the analog output to 20 mA.

You can configure the measured value assigned to the analog output, the start, average and end value as well as the output range 0 - 20 mA or 4 - 20 mA easily and clearly in the GridVis[®] software (**For further information on the configuration of the analog output, see section 13 on page 78**).

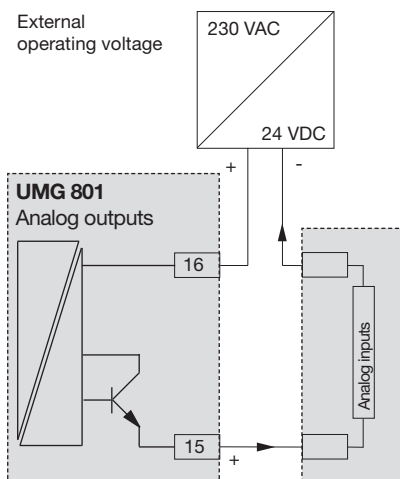
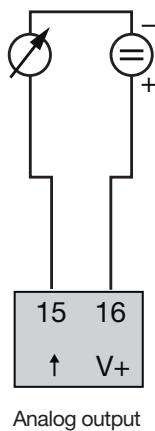

Fig. Connection example for the analog output

10. Operation and button functions

10.1 Controls

The device has a display and 6 function buttons to enable installation, commissioning and configuration without a PC. The 6 function buttons are used for:

- Selection of measured value displays.
- Navigation within the menus.
- Device configuration.

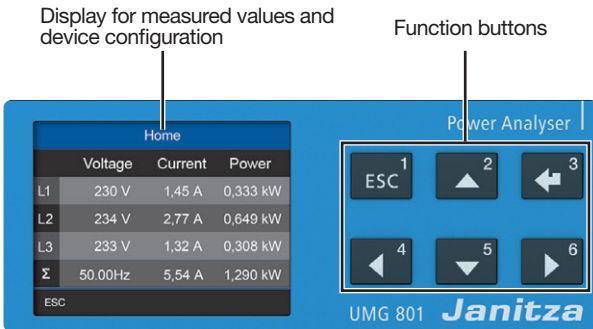

Fig. Measured value display UMG 801 "Home" and function buttons.

10.2 Function buttons

Button	Function
1 ESC	<ul style="list-style-type: none"> • Display menu. • One step back. • Cancel action (ESC) • Repeated actuation leads to the <i>Menu</i>.
2 ▲	<ul style="list-style-type: none"> • Select the menu or item (up, "▲"). • Change selection (digit +1).
3 ↵	<ul style="list-style-type: none"> • Confirm selection (Enter)
4 ◀	<ul style="list-style-type: none"> • Select position (to the left "◀").
5 ▼	<ul style="list-style-type: none"> • Select menu or item (down, "▼"). • Change selection (digit -1).
6 ▶	<ul style="list-style-type: none"> • Select position (to the right "▶").

Tab: Function buttons

After restoration of network power, the device starts with the measured value display *Home*. Pressing function button 1 *ESC* displays the *Menu*.

10.3 Measuring display

After restoration of network power, the device starts with the measured value display *Home*.

i INFORMATION

Note that the duration of the system start-up (booting) of the device may vary (e.g. depending on the number of modules connected). The "Booting indicator" appears during system startup.

Home			
	Voltage	Current	Power
L1	230 V	1.45 A	0.333 kW
L2	234 V	2.77 A	0.649 kW
L3	233 V	1.32 A	0.308 kW
Σ	50.00Hz	5,54 A	1,290 kW
ESC			

Fig. Measured value display "Home"

10.4 Menu

Pressing button 1 *ESC* opens the Menu containing the selection of the parameters and measured variables to be set (menu items).

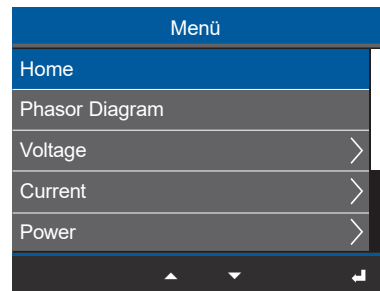

Fig. "Menu" window

10.5 PIN (password)

The “Configuration” of the device requires entry of a PIN (password). Default setting (factory setting) of the device PIN:

00000000

The “PIN” is used to protect against unauthorized access or accidental modification of the configuration data. The PIN configuration can be found at **Menu > Configuration > System > PIN**.

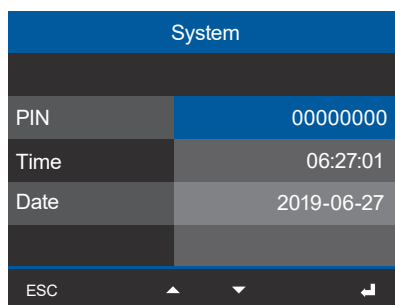

System	
PIN	00000000
Time	06:27:01
Date	2019-06-27
ESC ▲ ▼ ↵	

Display “System” > Entry “Password”

i INFORMATION

- To configure the PIN, please refer to section **11.7.1 on page 70**.
- For security and to protect against accidentally changing the device's configuration data, change your PIN!
- **Make a note of your PIN and keep it safe!**
- You cannot configure your device without a PIN!
If the PIN is lost, notify the manufacturer's Support!

10.6 Overview of menu displays

Menu

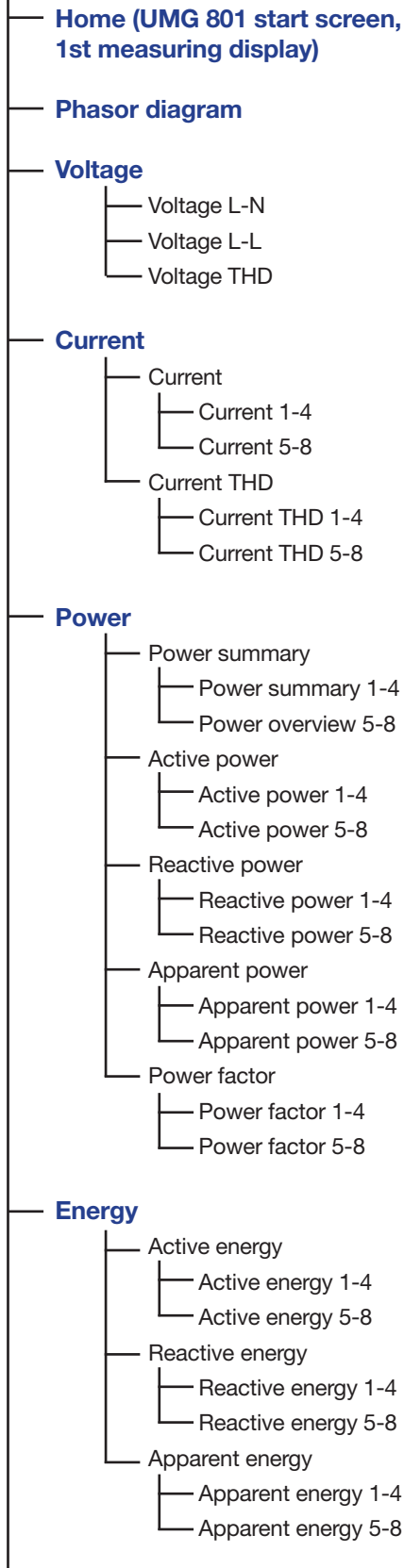

Multifunction channels

- Current measurement
- Temperature

Configuration

- Ethernet TCP/IP
 - IP configuration
 - IP address
 - Netmask
 - Gateway
- Field bus
 - Device address
 - Baud rate
 - Data frame
- Current transformer
 - Device
 - Current transformer 1..4 prim./sec.
 - Current transformer 5..8 prim./sec.
- Voltage transformer
 - Voltage transformer 1..4
- Display
 - Language
 - Brightness
 - Standby after
- System
 - Time
 - Password
- Reset
 - Standard factory settings
 - Restart
 - Min/max values

Diagnostics

- Identify all modules
- Identify one module

System Information

- Basic device
 - Serial number
 - MAC
 - IP address
 - Date
 - HW version
 - SW version
 - SW build
- Module 1
-
- Module n (up to 10 modules)

Select the menu item:

- Press button 1 *ESC*.
- The *Menu* window appears.
- Use the buttons 2 “▲” and 5 “▼” to select your menu item.
- Confirm your menu entry with button 3 *Enter*.
- The window of the selected menu item appears.
- Button 1 *ESC* undoes your step, or pressing it several times takes you back to the *Menu* window.

11. Configuration

11.1 The Configuration window

The Configuration menu of the device contains all parameters in which you make settings. The device requires the supply voltage for configuration. See section „14. Commissioning“ on page 80 on this.

- If you are in the measured value display *Home*, pressing button 1 *ESC* takes you to the *Menu* window.

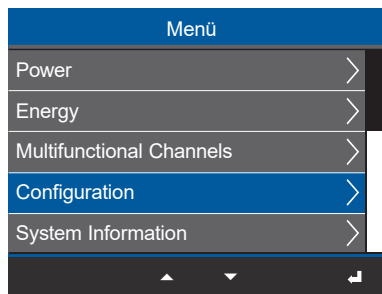

Fig. Window Menu -> Configuration item

- Use buttons 2 (▲) and 5 (▼) to select the menu item *Configuration* and confirm with button 3 *Enter*.
- The *Configuration* window appears.

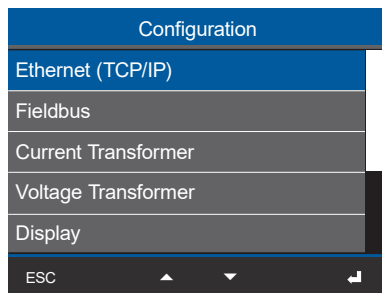

Fig. Configuration window

i INFORMATION

Password-protected devices require entry of a password before configuration! If your device is password protected, enter your password to open the Configuration window (see section „10.5 PIN (password)“ on page 61).

11.2 Configuring Ethernet (TCP/IP)

i INFORMATION

- **Consult your network administrator for the Ethernet network settings for your device.**
- Information on the connection and communication of your device with the software can be found in the online help for the GridVis® software.

After restoration of network power, the device starts with the measured value display *Home*.

- Press function button 1 *ESC* to open the menu.
- Use buttons 2 (▲) and 5 (▼) to select the menu item *Configuration* and confirm with button 3 *Enter*.
- The *Configuration* window with the entry *Ethernet (TCP/IP)* appears.
- Use buttons 2 (▲) and 5 (▼) to select the item

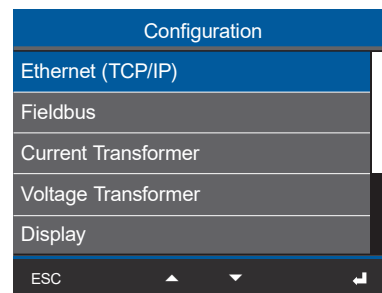

Fig. Window Configuration -> Ethernet (TCP/IP) item

Ethernet (TCP/IP) and confirm with button 3 *Enter*.

- The *Ethernet (TCP/IP)* window appears.

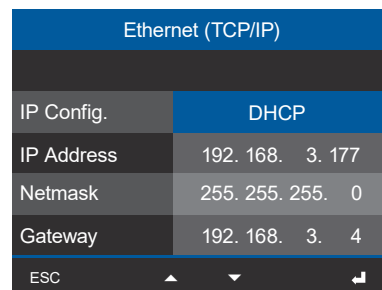

Fig. Ethernet (TCP/IP) window

11.2.1 Communication settings

The device has 2 types of address assignment for an Ethernet connection (TCP/IP):

1. Static (fixed IP address)

The user selects the IP address, netmask and gateway on the device. Use this mode for simple networks with no DHCP server.

2. DHCP

On start-up, the device is automatically given an IP address, netmask and gateway from the DHCP server.

The default setting of the device is DHCP!

Ethernet (TCP/IP)	
IP Config.	DHCP
IP Address	192. 168. 3. 177
Netmask	255. 255. 255. 0
Gateway	192. 168. 3. 4
ESC ▲ ▼ ↵	

Fig. Ethernet (TCP/IP) window

Configure your Ethernet (TCP/IP) settings via the function buttons (see chap. 10.2 on page 60) as follows:

- Select the item *IP configuration* (type of address assignment) and press button 3 *Enter*.
- The item *DHCP* (default setting) blinks “yellow”.
- If necessary, switch between the types of address assignment using buttons 2 (▲) and 5 (▼).
- Confirm your selection by pressing button 3 *Enter*.
- Go to the item *IP Address* (button 2 “▲” and 5 “▼”) and press button 3 *Enter*.
- The IP address entry blinks “yellow”.
- Use buttons 4 (◀) and 6 (▶) to change the position of the digit to be set and buttons 2 (▲) and 5 (▼) to change the digit (-1/+1).

Tip! Start by setting the right digit of each block of three.

- Finally, confirm your entry for the *IP address* with button 3 *Enter*.
- The configuration of the *Netmask* and the *Gateway* require the same procedure.
- When you have finished entering data, press button 1 *ESC* to return to the *Menu* window.

11.2.2 Communication via OPC UA

OPC UA is the standard for platform-independent data exchange. The data exchange via OPC UA takes place via the Ethernet interfaces of your device.

The Ethernet interface and data exchange using the OPC UA can be conveniently configured in the GridVis® software.

i INFORMATION

- Consult your network administrator for the correct Ethernet network settings for your device.
- Information on the connection and communication of your device with the software can be found in the online help for the GridVis® software.

11.3 Configuring the fieldbus (RS-485 interface)

After restoration of network power, the device starts with the default display *Home*.

- Press function button 1 *ESC* to open the menu.
- Use buttons 2 “▲” and 5 “▼” to select the menu item *Configuration* and confirm with button 3 *Enter*.
- The *Configuration* window with the entry *Fieldbus* appears.

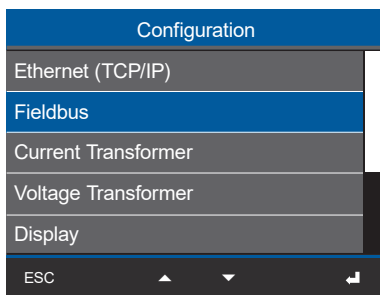

Fig. Window Configuration -> Fieldbus item

- Use buttons 2 “▲” and 5 “▼” to select the menu item *Fieldbus* and confirm with button 3 *Enter*.
- The window *Fieldbus* appears with the parameters:
 - Device address.
 - Baud rate.
 - Data frame.

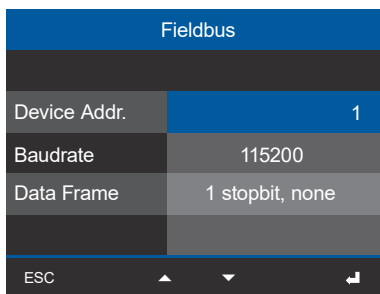

Fig. Fieldbus window

- Configure the parameters for the fieldbus (RS-485 interface) by selecting the respective entry and confirming with button 3 *Enter*.
- Depending on the parameter selected, the corresponding entry is shown in “yellow”.
- Use buttons 4 (◀) and 6 (▶) to change the position of the digit to be set and buttons 2 (▲) and 5 (▼) to change the digit (-1/+1).

- Confirm your entries with button 3 *Enter* or end the action by pressing button 1 *ESC*.
- When you have finished entering data, press button 1 *ESC* to return to the *Menu* window.

11.3.1 Communication settings

· **Device address:**

Select a device address for the device with which the device can be addressed in the bus structure. Each device address exists once in a bus structure! (see section „9.3 RS-485 interface (serial interface)“ on page 53)

Setting range: 1 - 247 (according to Modbus standard)

Default value: 1

· **Baud rate:**

Select a uniform baud rate for all devices in the bus structure!

Setting range: 9600, 19200, 38400, 57600, 115200 kbps.

Default value: 115200 kbps

· **Data frame:**

Select a uniform data framework for all devices in the bus structure. Setting range:

- "1 stop bit, odd" (parity odd, with 1 stop bit)
- "1 stop bit, even" (parity even, with 1 stop bit)
- "1 stop bit, none" (parity none, with 1 stop bit).
- "2 stop bits" (parity none, with 2 stop bits).
- **Default value: 1 stop bit, none (no parity).**

ATTENTION

Material damage due to incorrect network settings!

Incorrect network settings can cause malfunctions in the IT network.

Consult your network administrator for the correct network settings for your device.

11.4 Configuring current transformers

i INFORMATION

Before configuring the current transformer ratios, be certain to connect the transformers in compliance with the specifications on the device rating plate and the technical data!

- Press function button 1 *ESC* to open the menu.
- Use buttons 2 “▲” and 5 “▼” to select the menu item *Configuration* and confirm with button 3 *Enter*.
- The *Configuration* window appears.
- In the *Configuration* window, use buttons 2 “▲” and 5 “▼” to select the menu item *Current transformers* and confirm with button 3 *Enter*.
- The *Current transformers* window appears.

Configuration	
Ethernet (TCP/IP)	
Fieldbus	
Current Transformer	
Voltage Transformer	
Display	
ESC	▲ ▼ ↵

Fig. Window Configuration -> item Current transformer

- In the *Current transformers* window, choose the

Current Transformer		
Device	Main Device	
	Primary	Secondary
Transformer 1..4	5 A	5 A
Transformer 5..8	5 A	5 A
ESC	← ▲ ▼ ▶ ↵	

Fig. Window Current transformer -> item Device

- item *Device* and confirm with button 3 *Enter*.
- The *Device* item is shown in “blue”.
In the *Device* item, choose the basic device and possibly connected current measuring modules (up to 10 current measuring modules).
- Confirm the *Basic device* item with button 3 *Enter*.
- Use button 5 “▼” to go to the setting for the primary side of the current transformers (current measurement inputs I1..I4).

- The item for the primary side of the current transformers I1..I4 is marked in “blue”.

Current Transformer		
Device	Main Device	
	Primary	Secondary
Transformer 1..4	5 A	5 A
Transformer 5..8	5 A	5 A
ESC	← ▲ ▼ ▶ ↵	

Fig. Window Current transformer -> item Primary for current transformer 1..4.

- Press button 3 *Enter*.
 - The item for the primary side of the current transformers I1..I4 “blinks”.
 - Use buttons 4 (◀) and 6 (▶) to change the position of the digit to be set and buttons 2 (▲) and 5 (▼) to change the digit (-1/+1).
 - Confirm your entries with button 3 *Enter* or end the action by pressing button 1 *ESC*.
 - Use button 6 (▶) to go to the configuration of the secondary side of the current transformers I1..I4.
 - Configure the secondary side of the current transformers I1..I4 in the same way.
 - Confirm your entries with button 3 *Enter* or end the action by pressing button 1 *ESC*.
 - When you have finished entering data, press button 1 *ESC* to return to the *Menu* window.
- For the configuration of the **Current transformer ratios I5..I8**, press button 5 “▼” to go to the configuration of the primary side of the current transformers I5..I6.
 - Configure the **Current transformer ratios I5..I8** in accordance with the current transformer ratios I1..I4!

i INFORMATION

You can also configure current and voltage transformer ratios in the device configuration of the **Software GridVis®**. A description of the configuration in the software can be found in the corresponding online help and tutorials.

Current transformer settings (I1..I4 and I5..I8):

Current transformer (primary):
 Setting range 1 - 10000 A
Default value: 5 A

Current transformer (secondary):
 Setting range 1 - 5 A
Default value: 5 A

11.5 Configuring voltage transformers

***i* INFORMATION**

Before configuring the voltage transformer ratios, be certain to connect the transformers in compliance with the specifications on the device rating plate and the technical data!

- Press function button 1 ESC to open the *Menu* window.
- Use buttons 2 “▲” and 5 “▼” to select the menu item *Configuration* and confirm with button 3 Enter.
- The *Configuration* window appears.
- In the *Configuration* window, use buttons 2 “▲” and 5 “▼” to select the item *Voltage transformer* and confirm with button 3 Enter.

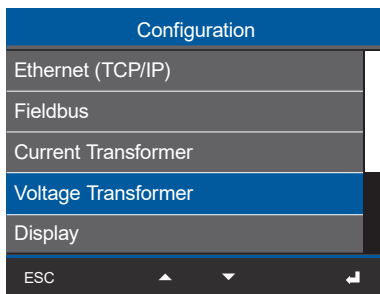

Fig. Window Configuration -> item Voltage transformer

- The *Voltage transformer* window appears with the item for the primary side 1..4 marked “blue”.

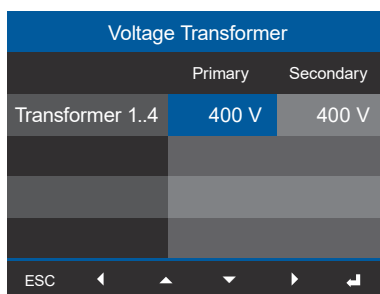

Fig. Window Voltage transformer -> item Primary for voltage transformer 1..4.

- Press button 3 *Enter*.
- The item for the primary side of the voltage transformers 1..4 “blinks”.
- Use buttons 4 (◀) and 6 (▶) to change the position of the digit to be set and buttons 2 (▲) and 5 (▼) to change the digit (-1/+1).
- Confirm your entries with button 3 *Enter* or end the action by pressing button 1 ESC.
- Use button 6 (▶) to go to the configuration of the secondary side of the voltage transformers 1..4.
- Configure the secondary side of voltage transformers 1..4 in the same way.
- Confirm your entries with button 3 *Enter* or end the action by pressing button 1 ESC.
- When you have finished entering data, press button 1 *ESC* to return to the *Menu* window.

Voltage transformer settings (1..4):

Voltage transformer (primary):
 Setting range 100 - 60000 V
Default value: 400 V

Voltage transformer (secondary):
 Setting range 100 - 400 V
Default value: 400 V

11.6 Configuring the display

Use the *Display* item of the meter to configure the following settings:

1. Language
2. Standby (after)
3. Brightness

11.6.1 Language

Using the *Language* item of the *Display* window, configure the language for the device's user interface:

- Press function button 1 *ESC* to open the *Menu* window.
- Use buttons 2 “▲” and 5 “▼” to select the menu item *Configuration* and confirm with button 3 *Enter*.
- The *Configuration* window appears.
- In the *Configuration* window, use buttons 2 “▲” and 5 “▼” to select the item *Display* and confirm with button 3 *Enter*.

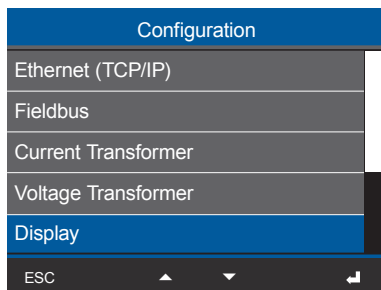

Fig. Window Configuration -> item Display

- The *Display* window appears with the *Language* item marked in “blue”.

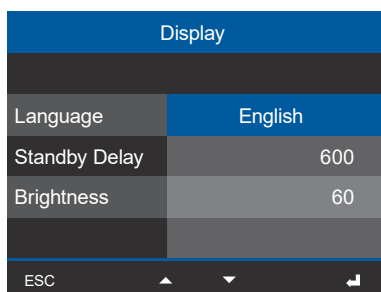

Fig. Window Display -> item Language

- Press button 3 *Enter*.
- The item *Language* appears in “yellow”.

- Use buttons 2 “▲” and 5 “▼” to select the language (**German** or **English**) and confirm with button 3 *Enter*.
- The user interface entries change to the selected language.
- Use button 1 *ESC* to return to the menu.

11.6.2 Standby (after)

Time in seconds after which the display brightness switches to the set brightness (Standby after).

Setting range: 10 s - 3600 s
Default value: 600 s

- Open the *Display* window as previously described.
- In the *Display* window, press button 5 “▼” to select the item *Standby (after)*. Press button 3 *Enter*.
- The item *Standby (after)* appears in “yellow”.

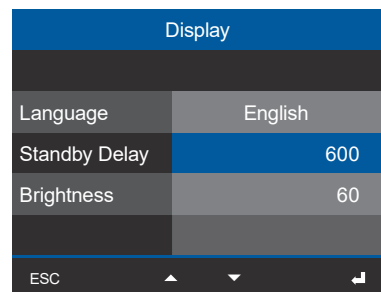

Fig. Window Display -> item Brightness

- Use buttons 4 (◀) and 6 (▶) to change the position of the digit to be set and buttons 2 (▲) and 5 (▼) to change the digit (-1/+1).
- Confirm your entries with button 3 *Enter* or end the action by pressing button 1 *ESC*.
- When you have finished entering data, press button 1 *ESC* to return to the *Menu* window.

11.6.3 Brightness

Use the item *Brightness* of the *Display* window to configure the brightness of the device display.

Setting range: 10% - 100%
 Default value: 60%
 Setting 10% = dark
 100% = very bright

- Open the *Display* window as previously described.
- In the *Display* window press button 5 “▼” to select the item *Brightness*.

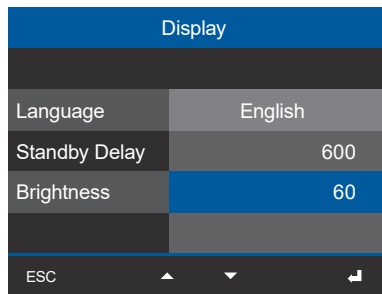

Fig. Window Display -> item Brightness

- Press button 3 *Enter*.
- The item *Brightness* appears in “yellow”.
- Use buttons 4 (◀) and 6 (▶) to change the position of the digit to be set and buttons 2 (▲) and 5 (▼) to change the digit (-1/+1).
- Confirm your entries with button 3 *Enter* or end the action by pressing button 1 *ESC*.
- When you have finished entering data, press button 1 *ESC* to return to the *Menu* window.

11.7 Configuring the system

Use the *System* item of the meter to configure the following settings:

1. PIN
2. Time
3. Date

11.7.1 PIN

The “*PIN*” function on the device is provided to protect the device's configuration data from unauthorized access or unintentional modification. The PIN consists of an 8-digit number combination. The default setting of the device PIN is:

00000000

Please note!

The PIN “00000000” allows open access to the device configuration (no PIN query)!

For security and to protect against accidentally changing the device's configuration data, change your PIN!

Setting a new PIN

- Open the *Configuration* window as previously described.
- In the *Configuration* window, use buttons 2 “▲” and 5 “▼” to select the item *System* and confirm with button 3 *Enter*.
- In the *System* window, use buttons 2 “▲” and 5 “▼” to select the item *PIN* (marked in “blue”) and confirm with button 3 *Enter*.

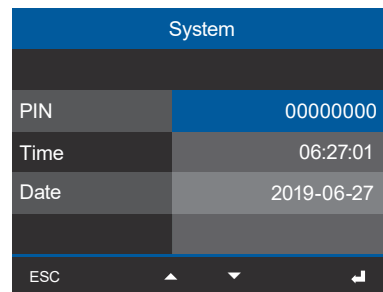

Fig. Window System -> item Password

- The item *PIN* appears in “yellow”.
- Use buttons 4 (◀) and 6 (▶) to change the position of the digit to be set and buttons 2 (▲) and 5 (▼) to change the digit (-1/+1).
- Confirm your entries with button 3 *Enter* or end the action by pressing button 1 *ESC*.

- The configuration data of the device are now protected with a **new PIN**.
- When you have finished entering data, press button 1 *ESC* to return to the *Menu* window.

i INFORMATION

- The meter's factory setting is **PIN 00000000**.
- For security and to protect against accidentally changing the device's configuration data, change your PIN!
- **Make a note of your PIN and keep it safe!**
- You cannot configure your device without a PIN!
If the PIN is lost, notify the manufacturer's Support!

11.7.2 Time

You can change the settings for the time, synchronization, and time zones using the **GridVis® software**.

The **Time display** can be accessed using **Menu > Configuration > System > Time**.

System	
PIN	00000000
Time	06:27:01
Date	2019-06-27
ESC ▲ ▼ ↩	

Fig. Window System -> item Time

11.7.3 Date

You can change settings for the date using the **GridVis® software**.

The **Date display** can be accessed using **Menu > Configuration > System > Date**.

System	
PIN	00000000
Time	06:27:01
Date	2019-06-27
ESC ▲ ▼ ↩	

Fig. Window System -> item Time

11.8 Reset

This function:

- Deletes your device settings (back to factory settings).
- Restarts the device.
- Deletes configured min. and max. values.

11.8.1 Standard factory settings

This function resets all settings, such as configurations and recorded data, to the factory settings.

- Open the Configuration window as previously described.
- In the *Configuration* window, use buttons 2 “▲” and 5 “▼” to select the item *Reset* and confirm with button 3 *Enter*.
- The *Reset* window appears.
- In the *Reset* window, use buttons 2 “▲” and 5 “▼” to select the item *Standard factory setting* (marked in “blue”) and confirm with button 3 *Enter*.

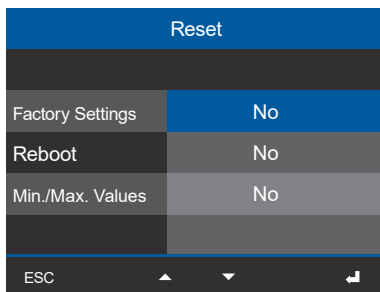

Fig. Window Reset - > item Factory settings

- The item *Standard factory setting* appears in “yellow”.
- Use the buttons 2 “▲” and 5 “▼” to select “Yes” or “No”.
- After confirming the entry “Yes” with button 3 *Enter*, a warning appears.
- Confirm the warning with button 3 *Enter* or end the action by pressing button 1 *ESC*.
- Pressing button 3 *Enter* boots the device and **resets it to the factory settings** (takes about 1 minute).
- The measured value display appears “Home”.

11.8.2 Restart

This function restarts the device.

- Open the Configuration window as previously described.
- In the *Configuration* window, use buttons 2 “▲” and 5 “▼” to select the item *Reset* and confirm with button 3 *Enter*.
- The *Reset* window appears.
- In the *Reset* window, use buttons 2 “▲” and 5 “▼” to select the item *Restart* (marked in “blue”) and confirm with button 3 *Enter*.

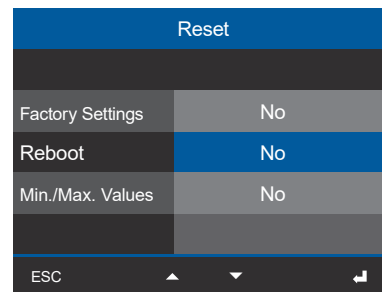

Fig. Window Reset -> item Restart

- The item *Restart* appears in “yellow”.
- Use the buttons 2 “▲” and 5 “▼” to select “Yes” or “No”.
- After confirming the entry “Yes” with button 3 *Enter*, a warning appears.
- Confirm the warning with button 3 *Enter* or end the action by pressing button 1 *ESC*.
- Pressing button 3 *Enter* **restarts the device** (takes about 1 minute).
- The measured value display appears “Home”.

11.8.3 Reset minimum, maximum and average values

With this function, the device user deletes all minimum, maximum and average values in the device simultaneously. It is not possible to select certain energy meters.

i INFORMATION

Before commissioning, delete any production-related contents of the energy meters, minimum, maximum and average values and records!

- Open the Configuration window as previously described.
- In the *Configuration* window, use buttons 2 “▲” and 5 “▼” to select the item *Reset* and confirm with button 3 *Enter*.
- The *Reset* window appears.
- In the *Reset* window, use buttons 2 “▲” and 5 “▼” to select the item *Min./max. values* (marked in “blue”) and confirm with button 3 *Enter*.

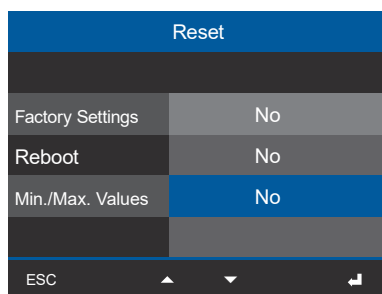

Fig. Window Reset -> item Min. / Max. values

- The item *Min. / Max. values* appears in “yellow”.
- Use the buttons 2 “▲” and 5 “▼” to select “Yes” or “No”.
- After confirming the entry “Yes” with button 3 *Enter*, a warning appears.
- Confirm the warning with button 3 *Enter* or end the action by pressing button 1 *ESC*.
- Pressing button 3 *Enter* **clears the minimum, maximum and average values of the device.**
- Press button 1 *ESC* to return to the *Menu* window.

11.9 Module identification / diagnostics

i INFORMATION

Before you start the module identification function (*Diagnostics* menu item) on the basic device, please make sure that the modules are mounted and connected correctly. Only correctly installed modules connected to the basic device guarantee the supply of power and data transmission.

The basic device has the option of extending the range of functions using current measuring modules (by up to 10 current measuring modules). The basic device recognizes the plugged in module automatically. The module identification can be configured via the *Diagnostics* menu item.

i INFORMATION

Detailed information about the modules, the *Diagnostics* menu item and on module identification can be found in the user manual of the modules.

12. Digital inputs and outputs

As described previously in the chapter „9. Peripherals“ on page 52, the device has 4 digital inputs and 4 digital outputs each.

You can configure the digital inputs and outputs easily and clearly in the GridVis® software. The GridVis® software is available for download from our website (www.janitza.de).

12.1 4 digital inputs

The digital inputs are used to send information from other devices with a digital output to your device (pulse counter).

In the “Peripherals” section of the “Configuration” window in the GridVis® software, an assistant guides you through the configuration of the 4 digital inputs with the following settings and functions:

1. **Value Type selection list** (of the incoming signal, e.g. electrical energy, gas/water/oil consumption, CO₂, etc.)
2. **Name of the user-defined value** - Depends on the value type. Optional name entry for the value type “User-defined values”.
3. **Unit of user-defined value** - Depends on the value type. Optional entry of the unit for the value type “User-defined values”.
4. **Scaling factor for the pulse/unit** - The unit depends on the configured value type. If the value type “User-defined values” is set, the pulse/unit selection list adopts the unit entered under “Unit of user-defined value”.

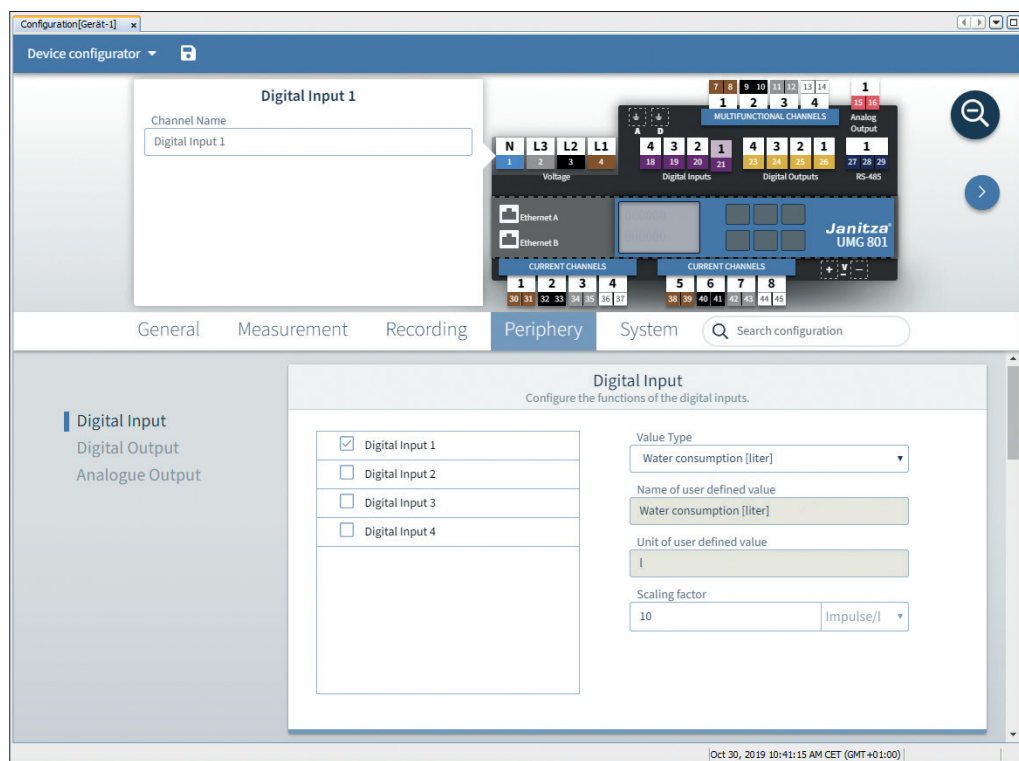

Fig. Assistant for configuring the digital inputs in the GridVis® software.

i INFORMATION

For detailed information on configuring the digital inputs of your device, refer to the online help for the GridVis® software.

Configuration of the digital inputs as pulse counters

All digital inputs can be operated with a frequency of 20 Hz. The pulse duration (pulse width) and the pulse pause must be greater than 20 ms. The typical pulse duration for S0 pulses is 30 ms.

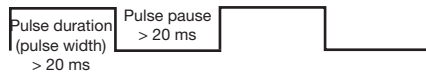

Fig. Pulse duration/pulse pause.

The maximum number of pulses per hour is calculated based on the minimum pulse duration and the minimum pulse pause:

Pulse duration (pulse width)	Pulse pause (pulse pause)	Max. pulses/h
20 ms	20 ms	90000 pul./h
30 ms	30 ms	60000 pul./h
50 ms	50 ms	36000 pul./h
100 ms	100 ms	18000 pul./h
500 ms	500 ms	3600 pul./h
1 s	1 s	1800 pul./h
10 s	10 s	180 pul./h

Fig. Examples of the maximum pulses per hour.

You configure the pulse counters with simultaneous measured-value or power calculation. The pulses are counted as a 64-bit number and the device has sufficient memory capacity for data acquisition.

Pulse valency

The pulse valency indicates what measured value or power value (e.g. energy) corresponds to a pulse. A pulse valency can be assigned to each digital input.

i INFORMATION

The pulse interval is proportional to the power within the selected settings.

Measured value calculation:

$$\text{Measured value} = \text{pulse} \times \text{pulse valency}$$

Power value calculation:

$$\text{Power value} = \frac{\text{Pulse} \times \text{pulse valency}}{\text{Time [s]}}$$

Since the pulse interval can be very large, continuous calculation of the measured or power values is not possible. Consequently, only average values are calculated. The calculation of the average values for the measured value calculation results from the number of pulses per period multiplied by the pulse valency. For the calculation of the mean power values, this value must be divided by a configurable time value.

The period is assigned to the respective digital input and can be set to between 1 and 60 minutes. After expiration of the period, the value can be accessed via the Modbus.

An external synchronization can be connected for each digital input, whereby one synchronization pulse completes a period and starts a new period. A catch time of 30 seconds is set for the external synchronization. If there is no synchronization pulse after the period has expired, the software takes over the synchronization after 30 seconds; also of the future periods.

Default setting for one period = 15 minutes

The calculation result of the S0 power value is available at the end of the period.

i INFORMATION

The programming in the GridVis® software shows a selection of energy values derived from the power values.

12.2 4 digital outputs

The 4 digital outputs of the device are used to produce pulses for counting the energy consumption. The current measuring channels of the basic device (or the selected module) are used as a reference in the form of measurement groups (measurement group 1 - I1 to I4, measurement group 2 - I5 to I8, measurement group 3 - multifunction channels).

In the “Peripherals” section of the “Configuration” window in the GridVis® software, an assistant guides you through the configuration of the 4 digital outputs with the following settings and functions:

1. **Segment selection list**
Selection of the device (basic device/modules).
2. **Measurement Group selection list** -
Selection of the measurement group of the respective device.
3. **Measured Value selection list** -
Selection of the measured value, e.g. active energy overall tariff, apparent energy overall tariff, reactive energy overall tariff, etc.
4. **Phase/Channel** -
Phase/channel whose pulse is used for the output.
5. **Pulse valency** -
See description for “Pulse output”.
6. **Pulse width (pulse duration)** -
See description „Pulse duration/pulse pause.“ on page 75.

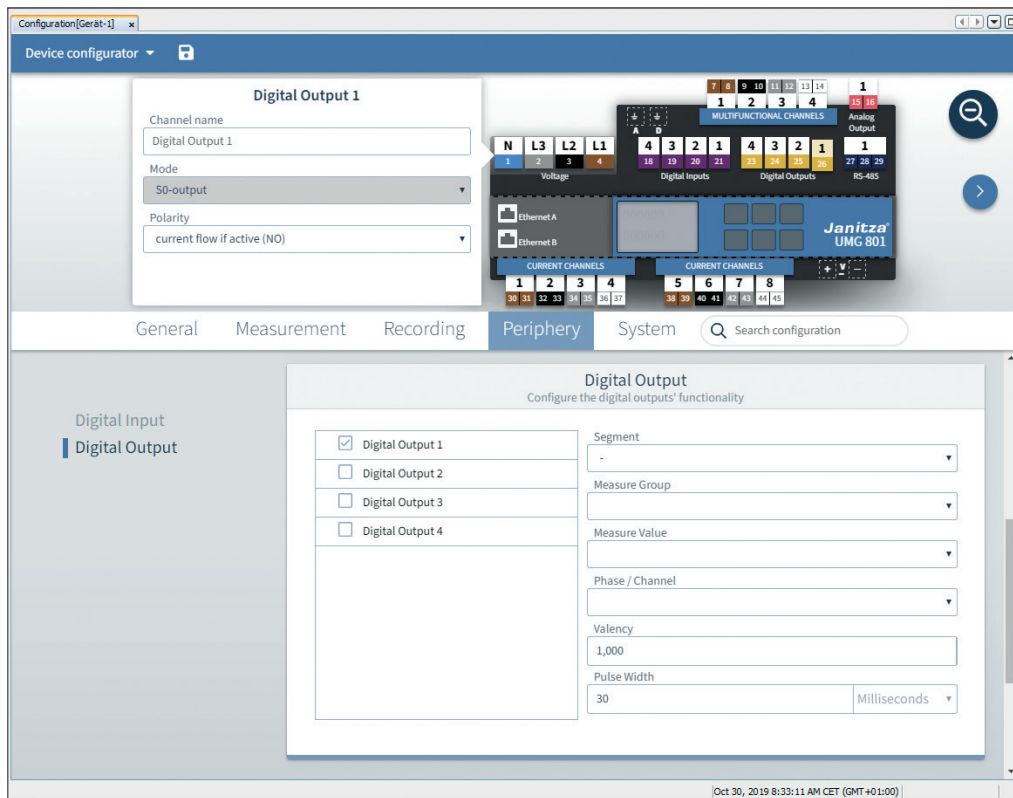

Fig. Assistant for configuring the digital outputs (GridVis® software)

i INFORMATION

For detailed information on configuring the digital outputs of your device, refer to the online help for the GridVis® software.

Pulse output

The digital outputs can be used to output pulses for counting the active energy, apparent energy and reactive energy. To do so, a pulse is generated at the output after a certain, configurable amount of energy has been reached.

To use a digital output as a pulse output, configure the corresponding settings in the configuration assistant of the GridVis® software:

- Output polarity: Normally open, normally closed
- Mode for the digital output: S0 output
- Pulse valency
- Pulse width

Pulse valency

The pulse valency indicates how much energy (Wh or varh) corresponds to one pulse.

The pulse valency is determined by the maximum connected load and the maximum number of pulses per hour.

If you indicate the pulse valency with:

- A positive sign, pulses are only output if the measured value also has a positive sign.
- A negative sign, pulses are only output if the measured value also has a negative sign.

i INFORMATION

Since the **Active energy meter** operates with a reverse running stop, the device only sends pulses when electrical energy is consumed.

Since the **Reactive energy meter** operates with a reverse running stop, the device only sends pulses when there is an inductive load.

1. Determine pulse valency

Set the pulse length according to the requirements of the connected pulse receiver. With a pulse duration of 30 ms, for example, the device can deliver a maximum number of 60000 pulses per hour (see table "Maximum pulses" on page 75).

2. Determine maximum connected load

Example:

Current transformer = 150/5 A
Voltage L-N = max. 300 V

Power per phase = 150 A x 300 V
= 45 kW

Power with 3 phases = 45 kW x 3
Max. Connected load = 135 kW

3. Calculate pulse valency

$$\text{Pulse valency} = \frac{\text{Max. connected load}}{\text{Max. number of pulses/h}} \quad [\text{Wh/pulse}]$$

Pulse valency = 135 kW / 60000 pulses/h

Pulse valency = 0.00225 kWh/pulse

Pulse valency = 2.25 Wh/pulse

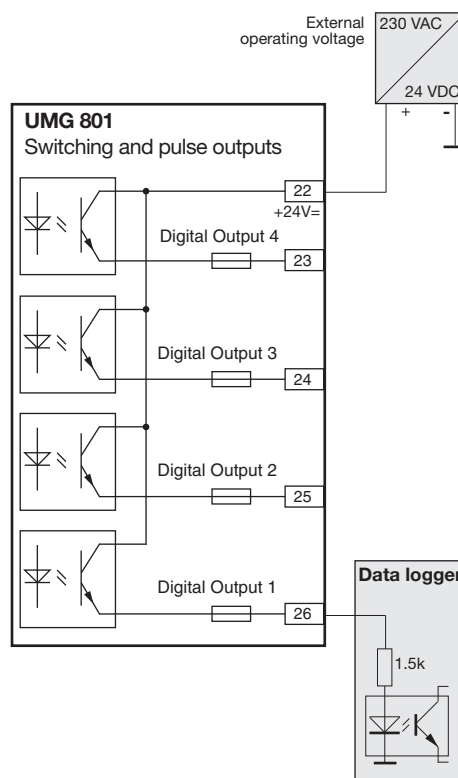

Fig. Connection example for wiring as a pulse output.

i INFORMATION

When using the digital outputs as pulse outputs, measurement errors can occur due to residual ripple. For the supply voltage (DC) of the digital inputs and outputs, use power supplies whose residual ripple is less than 5% of the supply voltage.

13. Analog outputs

The device has an analog output which:

- Supplies a current of up to 20 mA.
- Requires an external 24 V DC power supply for operation.

After activating the analog output, an assistant in the “Peripherals” section of the “Configuration” window in the GridVis® software, guides you through the configuration with the following settings and functions:

1. **Segment selection list**
Selection of the device (basic device/modules).
2. **Measurement Group selection list -**
Selection of the measurement group of the respective device.
3. **Measured Value selection list -**
Selection of the measured value.
4. **Phase/Channel -**
Phase/channel whose pulse is used for the output.
5. **Type of measured value -**
See description of “Pulse output”.
6. **Output signal**
4 - 20 mA or 0 - 20 mA.
7. **Start value**
See “Principle of analog output examples”.
8. **End value**
See “Principle of analog output examples”.

Principle of analog output examples:

Monitoring of **voltage** (output range 4 - 20 mA) :

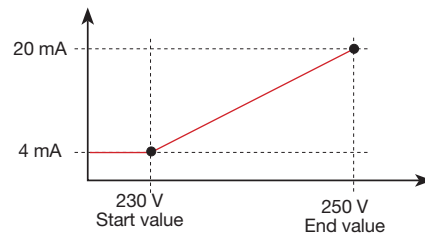

Allocation **active power L1** (output range 4 - 20 mA):

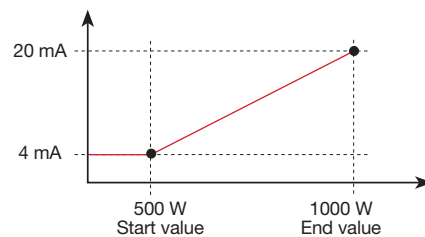

- With an active power of 500 W, the current at the analog output is 4 mA; with an active power of 1000 W --> 20 mA.
- The measured active power is proportional to the current at the analog output.

Allocation of the calculated **active power factor cos(math.)** (output range 4 - 20 mA):

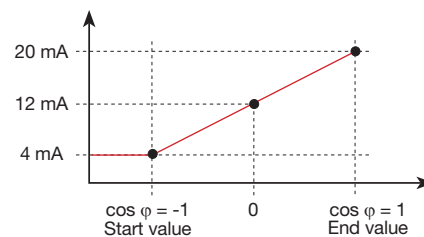

- Monitoring of the active power factor $\cos \varphi$ (math.) with:
 $\cos \varphi$ (math.) > 0 active power, applied.
 $\cos \varphi$ (math.) < 0 active power, delivered.

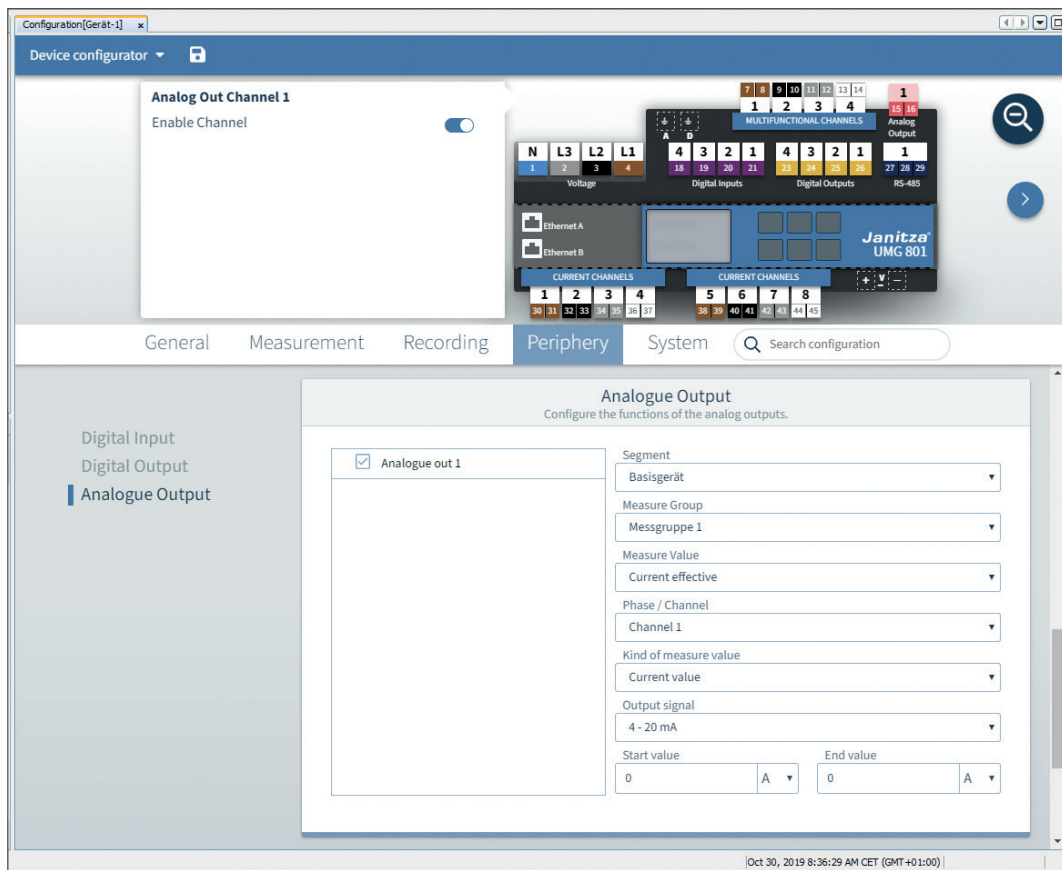

Fig. Assistant for configuration of the analog output (GridVis® software)

i INFORMATION

Information on configuring the analog output of your device can be found in the online help for the GridVis® software.

14. Commissioning

INFORMATION

Before commissioning, delete any production-related contents of the energy meters, minimum and maximum values as well as recordings (for further details see chapter „11.8 Reset“ on page 72).



WARNING

Material damage due to disregard of the connection instructions!

Voltages and currents outside the permissible measuring range can destroy the device.

Comply with the measuring range specifications from the technical data.

14.1 Supply voltage

Proceed as follows when applying the supply voltage:

1. Connect the supply voltage to terminals 46 and 47 of the device. The level of the supply voltage can be found on the rating plate or in the Technical Data section.
2. The standard display *Measured values* appears on the display.
3. If no display appears, check:
 - The connection of your device.
 - Whether the supply voltage is within the nominal voltage range.

INFORMATION

To connect the supply voltage, please observe all of the information in section „7.3 Supply voltage“ on page 33.

14.2 Measured voltage

Connect measured voltage:

1. Connect the measured voltage to the terminals provided for this purpose (see section „7.4 Voltage measurement“ on page 34).
2. After connecting the measured voltage, check the measured values displayed by the meter for the voltages L-N and L-L (take into account any voltage transformer factors that may have been set).

INFORMATION

- In networks that exceed the specified nominal voltages, make sure to connect the voltage measurement inputs via voltage transformers (see section „7.1 Nominal voltages“ on page 32)!
- The meter only measures if at least one voltage measurement input has an L-N voltage of $> 10 V_{\text{eff}}$ or an L-L voltage of $> 18 V_{\text{eff}}$ present.



WARNING

Risk of injury due to electrical voltage!

If the device is exposed to surge voltages above the permissible overvoltage category, safety-relevant areas of insulation in the device can be damaged. This means that the safety of the product can no longer be guaranteed.

Only use the device in environments in which the permissible overvoltage category is not exceeded (cf. section „19. Technical data“ on page 102).

14.3 Measured current

The device:

- Measures current exclusively via current transformers.
- Is designed for the connection of current transformers with secondary currents of $\dots/1$ A and $\dots/5$ A.
- Does not measure DC currents.
- Has current measurement inputs which can be loaded with 120 A (sinusoidal) for 1 second.

The factory-set current transformer ratio is 5/5 A and must be adapted to the current transformers used as needed.

The current transformers require a basic insulation according to IEC 61010-1:2010 for the nominal voltage of the circuit.

1. Short-circuit all current transformer outputs except one.
2. Compare the current displayed on the device with the applied input current.
 - The currents must match after taking the current transformer ratio into account.
 - In the short-circuited current measurement inputs, the device must indicate approx. 0 amperes.

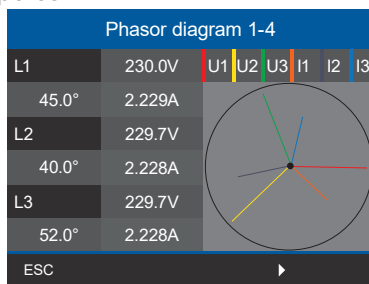
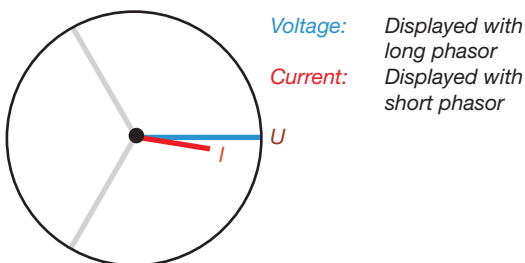

Fig. Phasor diagram

Sign of phase shift angle (U/I):

- Positive (+) with capacitive load.
- Negative (-) with inductive load.



i INFORMATION

For explanations of the phasor diagram, see section „14.6 Fundamentals on the phasor diagram“ on page 83.

14.4 Frequency measurement

For the measurement and calculation of measured values, the device requires the nominal or mains frequency. The mains frequency can either be specified by the user or determined automatically by the device.

- To determine the mains frequency, a voltage greater than 10 V_{eff} (4-conductor measurement) or a voltage L1-L2 greater than 18 V_{eff} (3-conductor measurement) must be applied to voltage measurement input V1.
- The mains frequency must be in the range from 40 Hz to 70 Hz.
- If the measured voltage is not sufficiently high, the device cannot determine the mains frequency and therefore cannot carry out a measurement.

14.5 Direction of rotary field

To determine the direction of the voltage rotating field, refer to the “Phasor diagram” display:

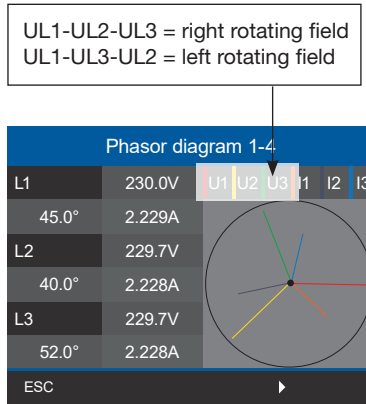

Fig. phasor diagram showing the phase sequence according to the direction of rotating field

- Press function button 1 ESC to open the menu.
- Use buttons 2 “▲” or 5 “▼” to select the menu item *Phasor diagram* and confirm with button 3 Enter.
- A submenu appears with the items *Phasor diagram 1-4* and *Phasor diagram 5-8*.

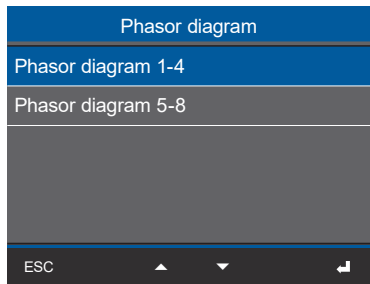

Fig. Submenu item Phasor diagram 1-4

- Use buttons 2 “▲” and 5 “▼” to select for example the menu item *Phasor diagram 1-4* and confirm with button 3 Enter.
- The *Phasor diagram 1-4* window appears.

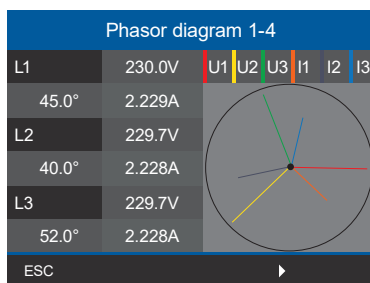

Fig. Window Phasor diagram 1-4

14.6 Fundamentals on the phasor diagram

The phasor diagram graphically describes the phase shift or phase angle between the voltage and the current. The phasors rotate at a constant angular speed – proportional to the frequency of the voltage and current – around an origin. The phasor diagram thus shows the momentary state of the variables in an AC circuit.

Representation of ohmic resistance:

- Voltage and current are in phase.

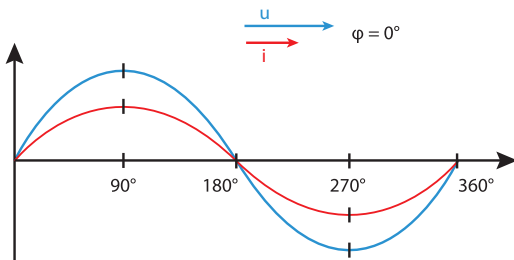

Representation of inductance:

- The voltage is ahead of the current.
- The phase shift for an “ideal coil” is 90° .

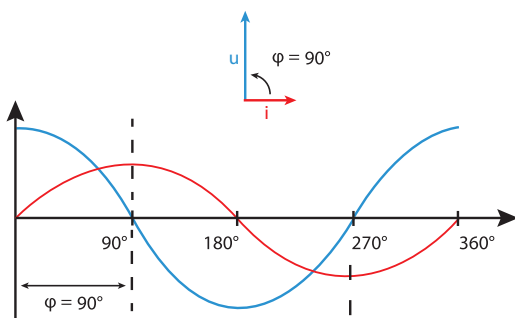

Representation of capacitance:

- The current is ahead of the voltage.
- The phase shift of an “ideal capacitor” is 90° .

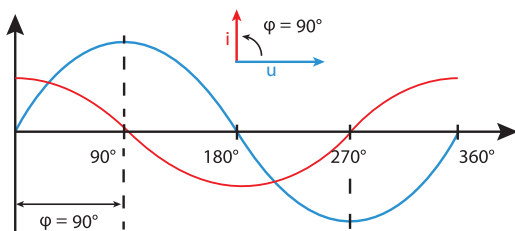

With a combination of the states, the phase angle “current to voltage” can assume values between -90° and $+90^\circ$.

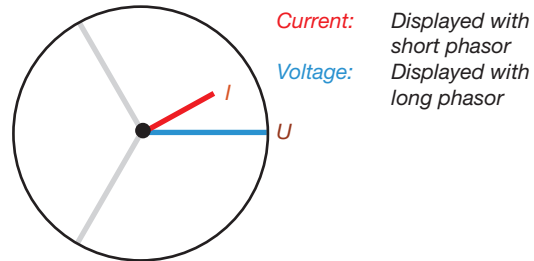

Example phasor diagram (3-phase)

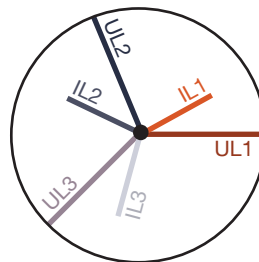

Current and voltage are shifted against each other. The current is ahead the voltage, i.e. the network is capacitively loaded.

14.7 Checking of voltage and current inputs by means of phasor diagram

The phasor diagram can be used to check incorrect connections at the voltage and current inputs.

Example 1

Primarily ohmic load.



Voltage and current have only a small deviation in the phase position.

- The current measurement input is assigned to the correct voltage measurement input

Example 2

Primarily ohmic load.



Voltage and current have a deviation of about 180° in the phase position.

- The measured current input is assigned to the correct voltage measurement input.
- In the current measurement under consideration, the connections k and l are reversed or there is a feedback into the supply network.

14.8 Checking the phase assignment

The assignment of the phase conductor to the current transformer is correct if a current transformer is short-circuited on the secondary side and the current indicated by the device in the associated phase conductor drops to 0 A.

14.9 Checking the power measurement

1. Short-circuit all current transformer outputs except one and check the indicated powers.
2. The device must only display power in the phase conductor with the current transformer output that is not short-circuited.
3. If this is not the case, check the connections of the measured voltage and the measured current.

If the amount of the measured active power is correct, but the sign is negative, this can have 2 causes:

1. Reversed connections S1(k) and S2(l) at current transformer or
2. Active energy is being delivered back into the grid.

14.10 Checking measurement

Correctly connected voltage and current measurement inputs result in correctly calculated and displayed individual and summation power readings.

14.11 Checking individual power

If a current transformer is assigned to the wrong phase, the corresponding power is measured and displayed incorrectly.

The phase conductor and current transformer are correctly assigned on the device if there is no voltage between the phase conductor and the associated current transformer (primary).

To ensure that a phase conductor at the voltage measurement input is assigned to the correct current transformer for the power measurement, the respective current transformer can be short-circuited on the secondary side. The apparent power displayed by the device must then be zero in this phase conductor.

If the apparent power is displayed correctly but the active power has a negative (“-”) sign, then the current transformer terminals are reversed or power is being supplied to the electric utility.

14.12 Checking summation power

If all voltages, currents and powers for the respective phase conductors are correctly displayed, the summation powers measured by the device are also correct. For confirmation, compare the summation power measured by the device with the work of the active and reactive power meters located in the power supply.

15. Overview of measured value and meter displays

i INFORMATION

The following measured-value and meter displays do not show a specific application and may differ depending on the connection of your measuring device and the measuring environment, e.g. for measurements in 3 or 4-conductor networks (TN, TT and IT networks) or for connected current measurement modules, etc.

Menu (Home)

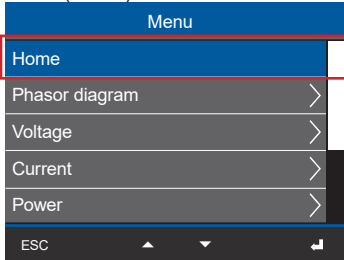

Network analysis (Start screen)

Home			
	Voltage	Current	Power
L1	230 V	1.45 A	0.333 kW
L2	234 V	2.77 A	0.649 kW
L3	233 V	1.32 A	0.308 kW
Σ	50.00Hz	5,54 A	1,290 kW

Display, Voltage L1, L2, L3; current L1, L2, L3; power L1, L2, L3; power factor; active and reactive energy L1-L3

Menu (Phasor diagram)

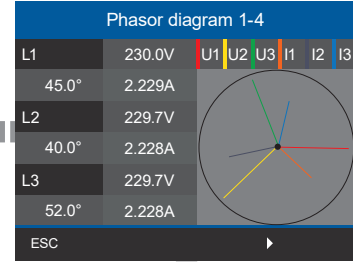
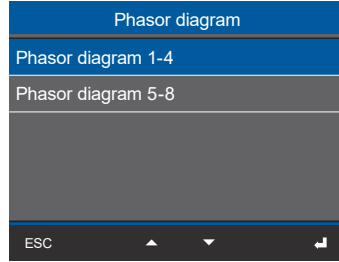
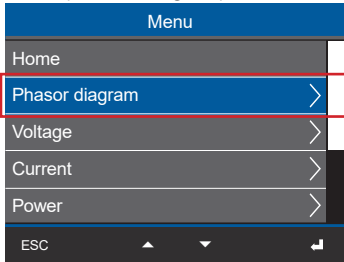

Display, Voltage L1, L2, L3; current L1, L2, L3; phase shift between voltage and current L1, L2, L3.

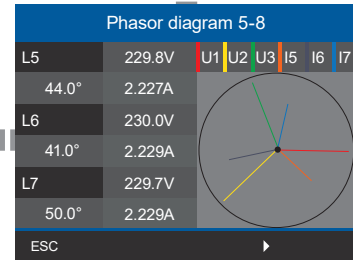
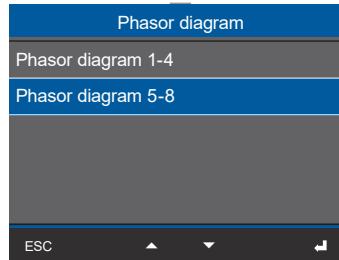

Display, Voltage L5, L6, L7; current L5, L6, L7; phase shift between voltage and current L5, L6, L7.

i INFORMATION

Depending on the measurement (4-conductor or 3-conductor measurement), the phasor diagrams (TN/TT network and IT network) will differ!

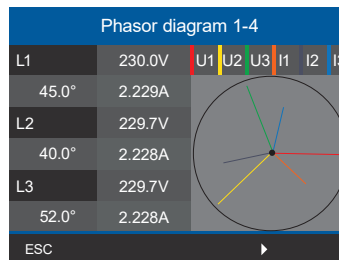

Fig. "Phasor diagram" of a 4-conductor measurement (e.g. TN or TT network)

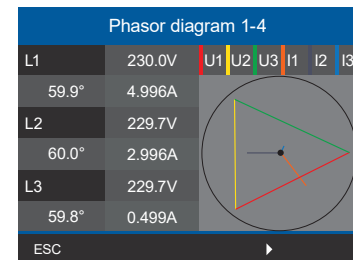
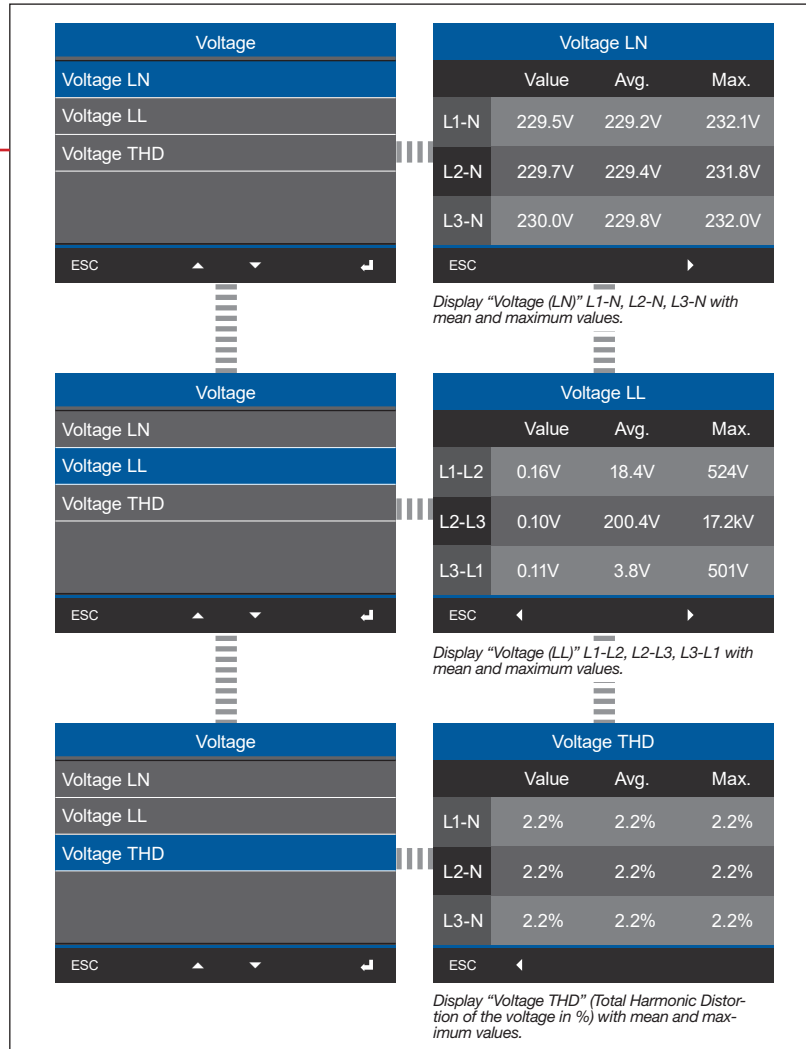

Fig. "Phasor diagram" of a 3-conductor measurement (IT network - ungrounded system)

Menu (Voltage)

Menu	
Home	
Phasor diagram	>
Voltage	>
Current	>
Power	>
ESC	▲ ▼ ▾



i INFORMATION

Total harmonic distortion (THD) shows the percentage of non-linear distortion in an electrical signal in % (comparison of the RMS value of all harmonics currents to the RMS value of the fundamental oscillation). THD-U is the distortion of the voltage and THD-I is the distortion of the current.

Menu (Current)

Menu	
Home	
Phasor diagram	>
Voltage	>
Current	>
Power	>
ESC	▲ ▼ ▾

Submenu (Current)

Current	
Current	>
THD I	>
ESC	▲ ▼ ▾

Submenu (THD-I)

Current	
Current	>
THD I	>
ESC	▲ ▼ ▾

Current	
Current 1-4	
Current 5-8	
ESC	▲ ▼ ▾

Current 1-4			
	Value	Avg.	Max.
L1	1.940A	1.940A	1.940A
L2	1.940A	1.940A	1.940A
L3	1.940A	1.940A	1.940A
L4	0.001A	0.001A	0.001A
ESC	▲ ▼ ▾		

Display "Current (1-4)" L1, L2, L3, L4 with mean and maximum values.

Current	
Current 1-4	
Current 5-8	
ESC	▲ ▼ ▾

Current 5-8			
	Value	Avg.	Max.
L5	1.930A	1.930A	1.930A
L6	1.930A	1.930A	1.930A
L7	1.930A	1.930A	1.930A
L8	0.001A	0.001A	0.001A
ESC	▲ ▼ ▾		

Display "Current (5-8)" L5, L6, L7, L8 with mean and maximum values.

THD I	
THD I 1-4	
THD I 5-8	
ESC	▲ ▼ ▾

THD I 1-4			
	Value	Avg.	Max.
L1	166.3%	166.3%	166.3%
L2	166.4%	166.4%	166.4%
L3	166.4%	166.4%	166.4%
L4	201.1%	207.0%	222.2%
ESC	▲ ▼ ▾		

Display "THD-I (1-4)" - L1, L2, L3, L4 (Total Harmonic Distortion of the current in %) with average and maximum values.

THD I	
THD I 1-4	
THD I 5-8	
ESC	▲ ▼ ▾

THD I 5-8			
	Value	Avg.	Max.
L5	166.3%	166.3%	166.3%
L6	166.4%	166.4%	166.4%
L7	166.4%	166.4%	166.4%
L8	209.3%	212.3%	227.6%
ESC	▲ ▼ ▾		

Display "THD-I (5-8)" - L5, L6, L7, L8 with mean and maximum values.

Menu (Power)

Menu	
Home	
Phasor diagram	>
Voltage	>
Current	>
Power	>
ESC	▲ ▼ ▾

Submenu (Power summary)

Power	
Power summary	>
Active power	>
Reactive power	>
Apparent power	>
Power factor	>
ESC	▲ ▼ ▾

Power summary	
Power summary 1-4	
Power summary 5-8	
ESC	▲ ▼ ▾

Power summary 1-4			
	P	Q	S
L1	0.10kW	-0.00kvar	0.19kVA
L2	0.10kW	-0.00kvar	0.19kVA
L3	0.10kW	-0.00kvar	0.19kVA
Σ	0.31kW	-0.00kvar	0.58kVA
ESC	▲ ▼ ▾ ▶		

Display "Summary of active, reactive and apparent power" for L1, L2, L3 and their sum.

Power summary	
Power summary 1-4	
Power summary 5-8	
ESC	▲ ▼ ▾

Power summary 5-8			
	P	Q	S
L5	0.11kW	-0.00kvar	0.20kVA
L6	0.11kW	-0.00kvar	0.20kVA
L7	0.11kW	-0.00kvar	0.20kVA
Σ	0.34kW	-0.00kvar	0.61kVA
ESC	◀ ▲ ▼ ▶		

Display "Summary of active, reactive and apparent power" for L5, L6, L7 and their sum.

Submenu (Active power)

Power	
Power summary	>
Active power	>
Reactive power	>
Apparent power	>
Power factor	>
ESC	▲ ▼ ▾

Active energy	
Active energy 1-4	
Active energy 5-8	
ESC	▲ ▼ ▾

Active power 1-4		
	Value	Avg.
L1	0.10kW	0.10kW
L2	0.10kW	0.10kW
L3	0.10kW	0.10kW
Σ	0.31kW	0.31kW
ESC	▲ ▼ ▾ ▶	

Display "Active power 1-4" for L1, L2, L3 with average values and sums.

Active power	
Active power 1-4	
Active power 5-8	
ESC	▲ ▼ ▾

Active power 5-8		
	Value	Avg.
L5	0.11kW	0.11kW
L6	0.11kW	0.11kW
L7	0.11kW	0.11kW
Σ	0.34kW	0.34kW
ESC	◀ ▲ ▼ ▶	

Display "Active power 5-8" for L5, L6, L7 with average values and sums.

Submenu (Reactive power)

Power	>
Power summary	>
Active power	>
Reactive power	>
Apparent power	>
Power factor	>
ESC	▲ ▼ ▾

Reactive power	
Reactive power 1-4	
Reactive power 5-8	
ESC	▲ ▼ ▾

Reactive power 1-4		
Value	Avg.	
L1	-0.02kvar	-0.01kvar
L2	-0.02kvar	-0.01kvar
L3	-0.02kvar	-0.01kvar
Σ	-0.06kvar	-0.02kvar
ESC	▲ ▼ ▾	▶

Display "Reactive power 1-4" for L1, L2, L3 with average values and sums.

Reactive energy	
Reactive energy 1-4	
Reactive energy 5-8	
ESC	▲ ▼ ▾

Reactive power 5-8		
Value	Avg.	
L5	-0.02kvar	-0.01kvar
L6	-0.02kvar	-0.01kvar
L7	-0.02kvar	-0.01kvar
Σ	-0.06kvar	-0.03kvar
ESC	▲ ▼ ▾	▶

Display "Reactive power 5-8" for L5, L6, L7 with average values and sums.

Submenu (Apparent power)

Power	>
Power summary	>
Active power	>
Reactive power	>
Apparent power	>
Power factor	>
ESC	▲ ▼ ▾

Apparent power	
Apparent power 1-4	
Apparent power 5-8	
ESC	▲ ▼ ▾

Apparent power 1-4		
Value	Avg.	
L1	0.19kVA	0.16kVA
L2	0.19kVA	0.16kVA
L3	0.19kVA	0.16kVA
Σ	0.58kVA	0.48kVA
ESC	▲ ▼ ▾	▶

Display "Apparent power 1-4" for L1, L2, L3 with average values and totals.

Apparent power	
Apparent power 1-4	
Apparent power 5-8	
ESC	▲ ▼ ▾

Apparent power 5-8		
Value	Avg.	
L5	0.20kVA	0.17kVA
L6	0.20kVA	0.17kVA
L7	0.20kVA	0.17kVA
Σ	0.61kVA	0.50kVA
ESC	▲ ▼ ▾	▶

Display "Apparent power 5-8" for L5, L6, L7 with average values and sums.

Submenu (Power factor)

Power	
Power summary	>
Active power	>
Reactive power	>
Apparent power	>
Power factor	>
ESC	▲ ▼ ▾ ▹

Power factor		
Power factor 1-4		
Power factor 5-8		
ESC ▲ ▼ ▾ ▹		

Power factor 1-4		
	cos(phi)	Power factor
L1	0.984	0.513
L2	0.985	0.513
L3	0.985	0.513
Σ	0.985	0.981
ESC ▲ ▼ ▾ ▹		

Display "Power factor 1-4" for L1, L2, L3 with cos(phi) and sums.

Power factor		
Power factor 1-4		
Power factor 5-8		
ESC ▲ ▼ ▾ ▹		

Power factor 5-8		
	cos(phi)	Power factor
L5	0.985	0.513
L6	0.985	0.513
L7	0.985	0.513
Σ	0.985	0.981
ESC ◀ ▲ ▼ ▾ ▹ ▶		

Display "Power factor 5-8" for L5, L6, L7 with cos(phi) and sums.

Menu (Energy)

Menu	
Power	>
Energy	>
Multifunctional channels	>
Configuration	>
Dagnostic	>
ESC ▲ ▼ ▾ ▹	

Submenu (Active energy)

Energy	
Active energy	>
Reactive energy	>
Apparent energy	>
ESC ▲ ▼ ▾ ▹	

Active energy	
Active energy 1-4	
Active energy 5-8	
ESC ▲ ▼ ▾ ▹	

Active energy 1-4	
Sum L1..L3	
Consumed	1.0kWh
Delivered	1.0kWh
ESC ▲ ▼ ▾ ▹	

Display "Active energy 1-4", sum L1..L3, applied and delivered.

Active energy	
Active energy 1-4	
Active energy 5-8	
ESC ▲ ▼ ▾ ▹	

Active energy 5-8	
Sum L1..L3	
Consumed	0.8kWh
Delivered	0.8kWh
ESC ◀ ▲ ▼ ▾ ▹ ▶	

Display "Active energy 5-8", sum L1..L3, applied and delivered.

Submenu (Reactive energy)

Energy	>
Active energy	>
Reactive energy	>
Apparent energy	>
ESC	▲ ▼ ▾

Submenu (Apparent energy)

Energy	>
Active energy	>
Reactive energy	>
Apparent energy	>
ESC	▲ ▼ ▾

<table border="1"> <tr><td>Reactive energy</td></tr> <tr><td>Reactive energy 1-4</td></tr> <tr><td>Reactive energy 5-8</td></tr> <tr><td>ESC</td></tr> </table>	Reactive energy	Reactive energy 1-4	Reactive energy 5-8	ESC	<table border="1"> <tr><td>Reactive energy 1-4</td></tr> <tr><td>Sum L1..L3</td></tr> <tr><td>Inductive 0.9kvarh</td></tr> <tr><td>Capacitive 0.9kvarh</td></tr> <tr><td>ESC</td></tr> </table>	Reactive energy 1-4	Sum L1..L3	Inductive 0.9kvarh	Capacitive 0.9kvarh	ESC
Reactive energy										
Reactive energy 1-4										
Reactive energy 5-8										
ESC										
Reactive energy 1-4										
Sum L1..L3										
Inductive 0.9kvarh										
Capacitive 0.9kvarh										
ESC										
<table border="1"> <tr><td>Reactive energy</td></tr> <tr><td>Reactive energy 1-4</td></tr> <tr><td>Reactive energy 5-8</td></tr> <tr><td>ESC</td></tr> </table>	Reactive energy	Reactive energy 1-4	Reactive energy 5-8	ESC	<table border="1"> <tr><td>Reactive energy 5-8</td></tr> <tr><td>Sum L1..L3</td></tr> <tr><td>Inductive 0.4kvarh</td></tr> <tr><td>Capacitive 0.4kvarh</td></tr> <tr><td>ESC</td></tr> </table>	Reactive energy 5-8	Sum L1..L3	Inductive 0.4kvarh	Capacitive 0.4kvarh	ESC
Reactive energy										
Reactive energy 1-4										
Reactive energy 5-8										
ESC										
Reactive energy 5-8										
Sum L1..L3										
Inductive 0.4kvarh										
Capacitive 0.4kvarh										
ESC										

Display "Reactive energy 1-4", sum L1..L3, inductive and capacitive.

Display "Reactive energy 5-8", sum L1..L3, inductive and capacitive.

<table border="1"> <tr><td>Apparent energy</td></tr> <tr><td>Apparent energy 1-4</td></tr> <tr><td>Apparent energy 5-8</td></tr> <tr><td>ESC</td></tr> </table>	Apparent energy	Apparent energy 1-4	Apparent energy 5-8	ESC	<table border="1"> <tr><td>Apparent energy 1-4</td></tr> <tr><td>Sum L1..L3</td></tr> <tr><td>Total 2.7kVAh</td></tr> <tr><td>ESC</td></tr> </table>	Apparent energy 1-4	Sum L1..L3	Total 2.7kVAh	ESC
Apparent energy									
Apparent energy 1-4									
Apparent energy 5-8									
ESC									
Apparent energy 1-4									
Sum L1..L3									
Total 2.7kVAh									
ESC									
<table border="1"> <tr><td>Apparent energy</td></tr> <tr><td>Apparent energy 1-4</td></tr> <tr><td>Apparent energy 5-8</td></tr> <tr><td>ESC</td></tr> </table>	Apparent energy	Apparent energy 1-4	Apparent energy 5-8	ESC	<table border="1"> <tr><td>Apparent energy 5-8</td></tr> <tr><td>Sum L1..L3</td></tr> <tr><td>Total 0.1kVAh</td></tr> <tr><td>ESC</td></tr> </table>	Apparent energy 5-8	Sum L1..L3	Total 0.1kVAh	ESC
Apparent energy									
Apparent energy 1-4									
Apparent energy 5-8									
ESC									
Apparent energy 5-8									
Sum L1..L3									
Total 0.1kVAh									
ESC									

Display "Apparent energy 1-4", sum L1..L3, total.

Display "Apparent energy 5-8", sum L1..L3, total.

Menu (Multifunction channels)

Menu	
Power	>
Energy	>
Multifunctional channels	>
Configuration	>
Diagnostic	>
ESC	▲ ▼ ▾

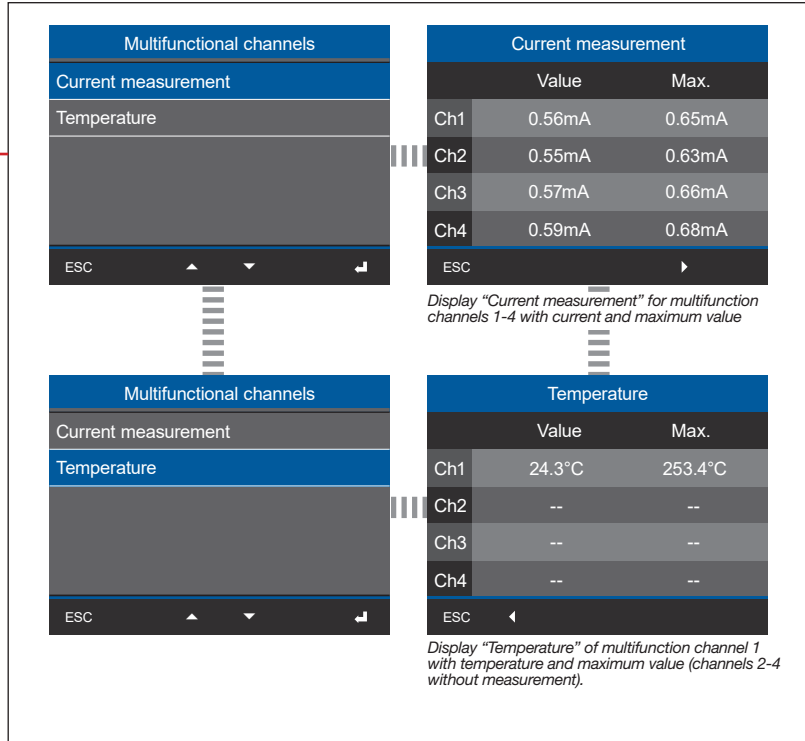

Menu (Configuration)

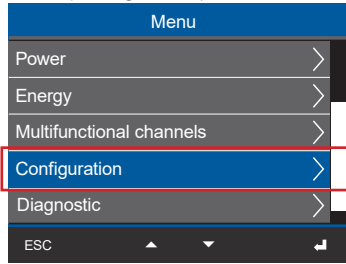

i INFORMATION

Descriptions of the configuration displays of the device can be found in section „11. Configuration“ on page 64.

Menu (Diagnostics)

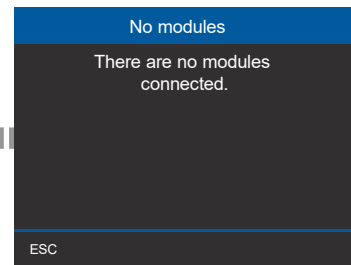
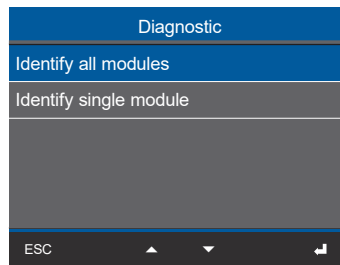
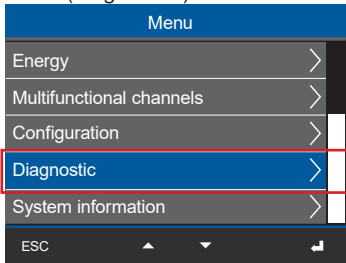

The display "Identify all modules" appears on the basic device only when modules are connected in series!

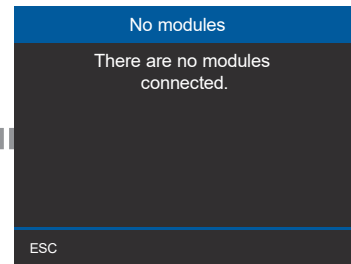
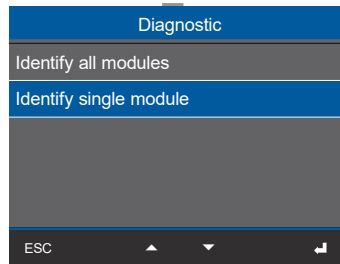

The display "Identify one module" appears on the basic device only with one module connected in series!

Menu (System information)

Menu	
Energy	>
Multifunctional channels	>
Configuration	>
Diagnostic	>
System informationen	>
ESC	▲ ▼ ▣



16. Connection example

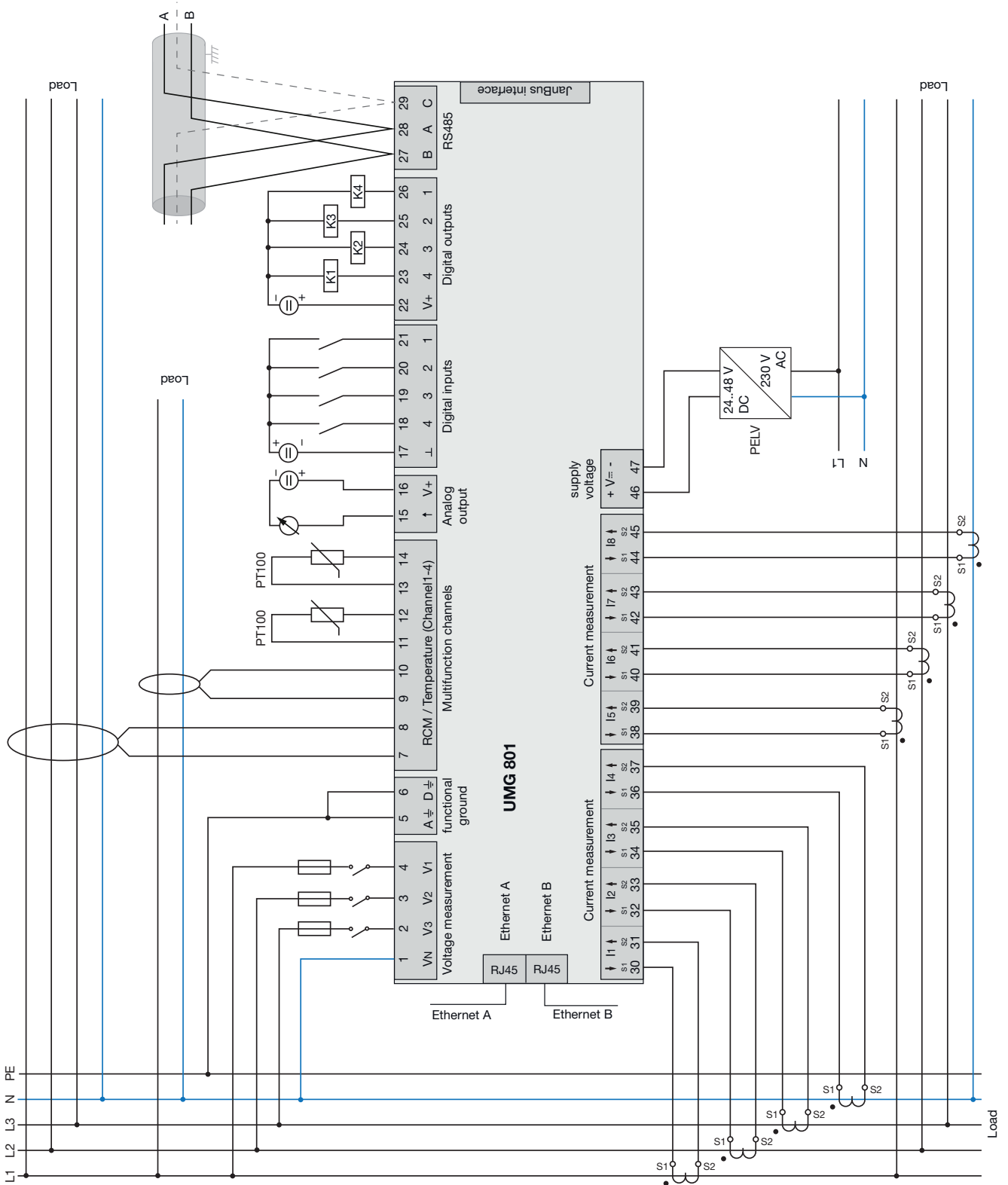

17. Service and maintenance

Prior to outbound delivery, the device is subjected to various safety tests and is marked with a seal.

INFORMATION

For opened devices (damaged or removed seal):

- New safety inspections are required for safe operation!
- The warranty expires!

The warranty is only valid for unopened devices!

17.1 Repair and calibration

Repair and calibration of the device must only be carried out by the manufacturer or an accredited laboratory!

The manufacturer recommends calibrating the device every 5 years!



WARNING

Warning of unauthorized tampering or improper use of the device.

Opening, dismantling or unauthorized manipulation of the device which goes beyond the mechanical, electrical or other operating limits indicated can lead to material damage or injury, up to and including death.

- **Only electrically qualified personnel are permitted to work on the devices and their components, assemblies, systems and current circuits!**
- **Always use your device or component only in the manner described in the associated documentation.**
- **In the event of visible damage, or for the purpose of repair and calibration, return the device to the manufacturer!**

17.2 Front panel foil and display

Please note the following for the care and cleaning of the front foil and the display:

ATTENTION

Material damage due to improper care and cleaning of the device.

The use of water or other solvents, such as denatured alcohol, acids, acidic agents for the front foil or the display can damage or destroy the device during cleaning. Water can, for example, penetrate into the device housing and destroy the device.

- **Clean the device, the front foil or the display with a soft cloth.**
- **Use a cloth moistened with clear water for heavy soiling.**
- **Clean the front foil and the display, e.g. of fingerprints, with a special LCD cleaner and a lint-free cloth.**
- **Do not use acids or acidic agents to clean the devices.**

17.3 Service

For questions not answered or described in this manual, please contact the manufacturer. Please be certain to have the following information ready to answer any questions:

- Device designation (see rating plate).
- Serial number (see rating plate).
- Software release (see system display).
- Measured voltage and supply voltage.
- An exact error description.

17.4 Device adjustment

The manufacturer adjusts the devices before delivery. No readjustment is required when the environmental conditions are complied with.

17.5 Firmware update

For a firmware update, connect your device to a computer and obtain access via the GridVis® software:

- Open the Firmware Update Assistant by clicking “Update device” in the “Extras” menu.
- Select your update file and perform the update.

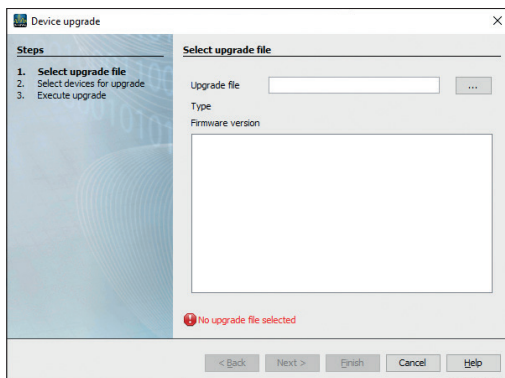

Fig. Updating the device firmware in the Grid Vis® software

17.6 Clock/Battery

The supply voltage supplies the internal clock of the meter. If the supply voltage fails, the battery takes over the supply of voltage to the clock. The clock provides date and time information, for example, for recordings, minimum/maximum values and events.

The life expectancy of the battery is at least 5 years at a storage temperature of +45 °C (113 °F). The typical life expectancy of the battery is 8 to 10 years.

17.7 Battery replacement

Have a battery replacement carried out by a qualified electrician and observe the following warnings:

⚠ WARNING

Risk of injury due to electrical voltage! Serious personal injury or death may occur due to:

- Touching bare or stripped leads that are energized.
- Device inputs that pose a hazard when touched.

Also observe the following when handling your device and when changing the battery, before starting work:

- Disconnect the system/device from the power supply!
- Secure it against being switched on!
- Check to be sure it is de-energized!
- Ground and short circuit!
- Cover or block off adjacent live parts!

⚠ CAUTION

Risk of injury due to fire or burns!
The battery used in the device may cause fire or burns if used improperly.

- **Only replace the battery with the same type or types recommended by Janitza!**
- **Observe the polarity when installing the battery!**
- **Remove batteries only with non-conductive tools (e.g. plastic tweezers)!**
- **Do not recharge, disassemble, burn or heat batteries above 100 °C (212 °F)!**
- **Do not dispose of batteries with household waste! Follow the disposal instructions in the respective device documentation!**
- **Keep batteries away from children and animals!**
- **In case of damage, return devices with a soldered battery to the manufacturer, observing proper transport conditions!**

i INFORMATION

Grease or dirt on the contact surfaces forms a contact resistance which shortens the service life of the battery. Touch the battery only at the edges or with non-conductive tools.

18. Error messages

18.1 Overrange

The measuring range is exceeded if at least one of the voltage or current measuring inputs lies outside its measuring range.

ATTENTION

Material damage due to disregard of the connection instructions!

Voltages and currents outside the permissible measuring range can destroy the device.

- Adhere to the measuring range specifications in section „19. Technical data“ on page 102!
- **If the measuring range is exceeded, check your installation and connections!**

If the measuring range is exceeded, the following warning appears in the instrument display, e.g. for the voltage, the warning “Overrange” with specification of the voltage circuit.

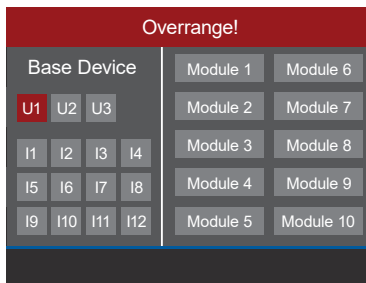

Fig. Example warning: Overvoltage U1

i INFORMATION

The device shows the overrange until it has been corrected! After elimination of the overrange, the corresponding measuring display appears.

Limit values for overrange conditions (200 ms effective values):

$$I = 6 A_{\text{eff}}$$

$$U_{L-N} = 720 V_{\text{eff}}$$

18.2 Procedure in the event of a malfunction

Failure mode	Cause	Remedy
No display	External fuse for the supply voltage has tripped.	Replace fuse.
No current display.	No measured voltage connected.	Connect measured voltage.
	No measured current connected.	Connect measured current.
Displayed current is too great or too small.	Current measurement on the wrong phase.	Check connection and correct if necessary.
	Current transformer factor incorrectly programmed.	Read and program the current transformer ratio on the current transformer.
	Current harmonic exceeds current peak value at measuring input.	Install current transformer with larger current transformer ratio.
	The current at the measuring input is too low.	Install current transformer with smaller current transformer ratio.
Displayed voltage is too high or too low.	Measurement on the wrong phase.	Check connection and correct if necessary.
	Voltage transformer programmed incorrectly.	Read the voltage transformer ratio on the voltage transformer and program.
Displayed voltage is too low.	Overrange.	Use a voltage transformer.
	The voltage peak value at the measuring input was exceeded due to harmonics current.	Attention! Make sure that the measuring inputs are not overloaded.
Incorrect display "Inductive/capacitive phase shift"	Current path assigned to the wrong voltage circuit.	Check connection and correct if necessary.
Active power consumed/delivered is reversed.	At least one current transformer connection is reversed.	Check connection and correct if necessary.
	One current path assigned to the wrong voltage circuit.	Check connection and correct if necessary.
Active power too small or too great.	Incorrectly programmed current transformer ratio.	Read and program the current transformer ratio on the current transformer.
	Current path assigned to the wrong voltage circuit.	Check connection and correct if necessary.
	Incorrectly programmed voltage transformer ratio.	Read the voltage transformer ratio on the voltage transformer and program.
An input/output is not responding.	Incorrectly programmed input/output.	Check programming and correct if necessary.
	Incorrectly connected input/output.	Check connection and correct if necessary.
"Overrange" display	The measuring range has been exceeded.	Check connection and correct if necessary. Correct current/voltage transformer ratio.
No connection to the device	OPC UA: - Incorrect IP address/port	- Correct the IP address/port.
	RS-485: - Incorrect device address - Different bus speeds (baud rate) and/or data frames. - Incorrect protocol. - No termination.	- Correct the device address. - Correct the speed (baud rate). Correct the data frame. - Correct the protocol. - Terminate bus with termination resistor.
Despite the above measures, the device does not function.	Device defective.	Send the device and error description to the manufacturer for inspection.

ATTENTION

Material damage due to overloaded measuring inputs!

Too high current and voltage values overload the measuring inputs and can damage the device.

- Adhere to the limit values specified on the rating plate and in the technical data starting on **page 102!**
- **Check your installation and connections!**

19. Technical data

19.1 Technical data

General	
Net weight	420 g (0.93 lb)
Device dimensions	Approx. B = 144 mm (5.67 in), H = 90 mm (3.54 in), D = 76 mm (2.99 in)
Battery	Type: Lithium CR2032, 3 V (UL1642 approval)
Integrated memory	4 GB
Backlight service life	40000 h (50% of the start brightness)
Mounting orientation	As desired
Fastening/mounting - Suitable DIN rails - 35 mm (1.38 in)	<ul style="list-style-type: none"> · TS 35/7.5 according to EN 60715 · TS 35/10 · TS 35/15 x 1.5
Impact resistance	IK07 according to IEC 62262

Transport and storage	
The following specifications apply for devices transported and stored in the original packaging.	
Free fall	1 m (39.37 in)
Temperature	-25° C (-13 °F) to +70° C (158 °F)
Relative humidity	5 to 95% RH at 25 °C (77 °F), no condensation

Environmental conditions during operation	
The device: <ul style="list-style-type: none"> • For weather-protected and stationary use. • Fulfills operating conditions according to DIN IEC 60721-3-3. • Has protection class II according to IEC 60536 (VDE 0106, part 1), a ground wire connection is not required! 	
Rated temperature range	-10 °C (14 °F) to +55 °C (131 °F)
Relative humidity	5 to 95% at 25 °C (77 °F), no condensation
Operating elevation/overvoltage category	2000 m (1.24 mi) above sea level Voltage measurement: 1000 V CATIII; 600 V CATIV Current measurement: 300 V CATII
	4000 m (2.49 mi) above sea level Voltage measurement: 600 V CATIII; Current measurement: 300 V CATII
Pollution degree	2
Ventilation	No forced ventilation required.
Protection against foreign matter and water	IP20 according to EN60529

Supply voltage	
Nominal range	DC: 24 V - 48 V, PELV
Operating range	+/-10% of nominal range
Power consumption	max. 4 W
Maximum power consumption with 10 modules	12 W (UMG 801 at 4 W plus 10 modules at 0.8 W each)
Recommended overcurrent protective device for line protection	2-6 A, (Char. B), IEC-/UL approval

Voltage measurement	
3-phase 4-conductor systems with rated voltages up to	480 V _{LN} / 830 V _{LL} (+/-10%) according to IEC 347 V _{LN} / 600 V _{LL} (+/-10%) according to UL
3-phase 3-conductor systems (grounded) with rated voltages up to	830 V _{L-L} (+/-10%) according to IEC 600 V _{L-L} (+/-10%) according to UL
3-phase 3-conductor systems (non-grounded) with rated voltages up to	690 V _{L-L} (+/-10%) according to IEC 600 V _{L-L} (+/-10%) according to UL
Overvoltage category	· 1000 V CAT III according to IEC · 600 V CAT III according to UL
Rated surge voltage	8 kV
Protection of the voltage measurement	1 - 10 A tripping characteristic B (with IEC/UL approval)
Measuring range L-N	0 ¹⁾ .. 720 V _{eff} (max. overvoltage 1000 V _{eff})
Measuring range L-L	0 ¹⁾ .. 1000 V _{eff} (max. overvoltage 1000 V _{eff})
Measuring range N-PE	up to 100 V
Resolution	16 bit
Crest factor	1.6 (referred to measuring range 600 V L-N)
Impedance	4 MΩ/phase
Power consumption	approx. 0.1 VA
Sampling frequency	51.2 kHz
Frequency of fundamental oscillation - Resolution	40 Hz .. 70 Hz 0.01 Hz
Harmonics	1 .. 127.

1) ... The device only measures if at least one voltage measurement input has an L-N voltage of > 10 V_{eff} or an L-L voltage of > 18 V_{eff} present.

Current measurement (../1 A) (../5 A)	
Nominal current	5 A
Channels	8 · 2 systems - L1, L2, L3, N (optional) · Single channels
Measurement range	0.005 .. 6 A _{eff}
Crest factor (relative to nominal current)	1.98
Overload for 1 s	120 A (sinusoidal)
Resolution	0.1 mA (color graphic display 0.01 A)
Overvoltage category	300 V CATII
Rated surge voltage	2.5 kV
Power consumption	approx. 0.2 VA (R _i = 5 mΩ)
Sampling frequency	25.6 kHz
Harmonics	1 .. 63

The device has, optionally, 4 multifunction channels, for use as

- Residual current measuring inputs and/or temperature measuring inputs (mixed),
- Additional system inputs (L1, L2, L3; N)

Residual current measurement (RCM)	
Nominal current	30 mA _{eff}
Measurement range	0 .. 40 mA _{eff}
Operating current	50 µA
Resolution	1 µA (color graphic display 0.01 A)
Crest factor	1.414 (relative to 40 mA)
Load	4 Ω
Overload for 20 ms	50 A
Overload for 1 s	5 A
Permanent overload	1 A
Norm	IEC/TR 60755 (2008-01), Type A, Type B and B+ (via corresponding current transformers)

Temperature measurement	
Update time	1 s
Total load (sensor and cable)	max. 4 kΩ
Cable	Up to 30 m (32.81 yd) not shielded Greater than 30 m (32.81 yd) shielded
Suitable sensor types	KTY83, KTY84, PT100, PT1000

Digital inputs 4 digital inputs, solid state relays, not short-circuit proof.	
Maximum counter frequency	20 Hz
Input signal applied	18 ... 28 V DC (typically 4 mA)
Input signal not applied	0 .. 5 V DC, current less than 0.5 mA

Digital outputs 4 digital outputs, solid state relays, not short-circuit proof.	
Switching voltage	Max. 60 V DC
Switching current	max. 50 mA _{eff} DC
Response time	approx. 500 ms
Digital output (energy pulses)	max. 20 Hz

Cable length (digital inputs/outputs)	
Up to 30 m (32.81 yd)	Unshielded
Greater than 30 m (32.81 yd)	Shielded

Analog outputs 1 channel	
External supply	max. 33 V DC
Current	0/4...20 mA DC
Update time	0.2 s
Load	max. 300 Ω
Resolution	10 bit

RS-485 interface 3-conductor connection with A, B, GND	
Protocol	Modbus RTU/Slave Modbus RTU/Gateway
Transmission rate	9.6 kbps, 19.2 kbps, 38.4 kbps, 57.6 kbps, 115.2 kbps
Termination	DIP switches

Ethernet interfaces	
Connection	2 x RJ45
Function	Modbus gateway
Protocols, services	OPC UA, DHCP, Modbus/TCP, NTP
Time synchronization	NTP

Connecting capacity of the terminals (supply voltage) Connectible conductors. Only connect one conductor per terminal point!	
Single core, multi-core, fine-stranded	0.2 - 2.5 mm ² , AWG 26-12
Wire ferrules (non-insulated) - Recommended stripping length	0.2 - 2.5 mm ² , AWG 26-12 10 mm (0.3937 in)
Wire ferrules (insulated) - Recommended stripping length	0.2 - 2.5 mm ² , AWG 26-12 13 mm (0.5118 in)
Wire ferrules: Length of the contact sleeve	10 mm (0.3937 in)

Connecting capacity of the terminals (current measurement) Connectible conductors. Only connect one conductor per terminal point!	
Single core, multi-core, fine-stranded	0.2 - 2.5 mm ² , AWG 26-12
Wire ferrules (non-insulated) - Recommended stripping length	0.2 - 2.5 mm ² , AWG 26-12 10 mm (0.3937 in)
Wire ferrules (insulated) - Recommended stripping length	0.2 - 2.5 mm ² , AWG 26-12 13 mm (0.5118 in)
Screw flange tightening torque	0.2 Nm (1.77 lbf in)
Wire ferrules: Length of the contact sleeve	10 mm (0.3937 in)

Connecting capacity of the terminals (voltage measurement)	
Connectible conductors. Only connect one conductor per terminal point!	
Single core, multi-core, fine-stranded	0.08 - 4 mm ² , AWG 28-12
Wire ferrules (insulated/non-insulated)	0.25 - 2.5 mm ² , AWG 24-14
Strip length	8-9 mm (0.3150 - 0.3543 in)

Connecting capacity of the terminals (functional earth A/D)	
Connectible conductors. Only connect one conductor per terminal point!	
Single core, multi-core, fine-stranded	0.2 - 4 mm ² , AWG 24-12
Wire ferrules (non-insulated)	0.2 - 4 mm ² , AWG 24-12
Wire ferrules (insulated)	0.2 - 2.5 mm ² , AWG 26-14
Tightening torque	0.4 - 0.5 Nm (3.54 - 4.43 lbf in)
Strip length	7 mm (0.2756 in)

Connecting capacity of the terminals - Multifunction channels (RCM, Temp.)	
Connectible conductors. Only connect one conductor per terminal point!	
Single core, multi-core, fine-stranded	0.2 - 1.5 mm ² , AWG 24-16
Wire ferrules (non-insulated)	0.2 - 1.5 mm ² , AWG 26-16
Wire ferrules (insulated)	0.2 - 1 mm ² , AWG 26-18
Tightening torque	0.2 - 0.25 Nm (1.77 - 2.21 lbf in)
Strip length	7 mm (0.2756 in)

Connecting capacity of the terminals (digital inputs/outputs, analog output)	
Single core, multi-core, fine-stranded	0.2 - 1.5 mm ² , AWG 24-16
Wire ferrules (non-insulated)	0.2 - 1.5 mm ² , AWG 26-16
Wire ferrules (insulated)	0.2 - 1 mm ² , AWG 26-18
Tightening torque	0.2 - 0.25 Nm (1.77 - 2.21 lbf in)
Strip length	7 mm (0.2756 in)

Connecting capacity of the terminals (RS-485)	
Single core, multi-core, fine-stranded	0.2 - 1.5 mm ² , AWG 24-16
Wire ferrules (non-insulated)	0.2 - 1.5 mm ² , AWG 26-16
Wire ferrules (insulated)	0.2 - 1 mm ² , AWG 26-18
Tightening torque	0.2 - 0.25 Nm (1.77 - 2.21 lbf in)
Strip length	7 mm (0.2756 in)

Potential isolation and electrical safety of the interfaces

The interfaces (RS-485, Ethernet) have:

- Double insulation to the inputs of the voltage and current measurement.
- Functional insulation relative to each other, to the supply voltage, to the measuring inputs for residual current and temperature, to the digital inputs/outputs and to the analog output.

The interfaces of the connected devices require double or reinforced insulation against mains voltages (according to IEC 61010-1: 2010).

Potential isolation and electrical safety of the multifunction channels (RCM, Temp.)

The inputs of the multifunction channels have:

- Double insulation to the inputs of the voltage and current measurement.
- No insulation to each other or to the supply voltage.
- Functional isolation to the Ethernet, RS-485 interfaces, to the digital inputs/outputs and to the analog output.

External sensors and/or transformers require double insulation relative to system components with dangerous touch voltages (according to IEC61010-1:2010).

Potential isolation and electrical safety of the digital inputs and outputs (I/Os) and the analog output

The digital inputs and outputs as well as the analog output are equipped with:

- Double insulation to the inputs of the voltage and current measurement.
- Functional isolation relative to each other, to the supply voltage, to the Ethernet, RS-485 and multifunction channel interfaces.

19.2 Performance characteristics of functions

Function	Symbol	Accuracy class	Measurement range	Display range
Frequency	f	0.05 (IEC61557-12)	40 .. 70 Hz	40.00 .. 70.00 Hz
Voltage	U_{L-N}	0.2 (IEC61557-12)	10 .. 720 V_{eff}	0 .. 999 kV
Voltage	U_{L-L}	0.2 (IEC61557-12)	18 .. 1000 V_{eff}	0 .. 999 kV
Voltage harmonics currents	I_h	Cl. 1 (IEC61000-4-7)	1 .. 127	0 .. 999 kV
THD of the voltage	THDu	1.0 (IEC61557-12)	0 .. 999%	0 .. 999%

Function	Symbol	Accuracy class - 5 A nominal current	Measurement range	Display range
Total active power	P	0.2 (IEC61557-12)	0 .. 12.6 kW	0 .. 999 GW
Total reactive power	QA, Qv	1 (IEC61557-12)	0..16.6 kvar	0 .. 999 Gvar
Total apparent power	SA, Sv	0.5 (IEC61557-12)	0 .. 12.6 kVA	0 .. 999 GVA
Total active energy	Ea	0.2 (IEC61557-12) 0.2S (IEC62053-22)	0 .. 999 GWh	0 .. 999 GWh
Total reactive energy	ErA, ErV	1 (IEC61557-12)	0 .. 999 Gvarh	0 .. 999 Gvarh
Total apparent energy	EapA, EapV	0.5 (IEC61557-12)	0 .. 999 GVAh	0 .. 999 GVAh
Phase current	I	0.2 (IEC61557-12)	0.005 .. 6 A_{eff}	0 .. 999 kA
Neutral conductor current calculated	INc	1.0 (IEC61557-12)	0.03 .. 25 A	0.03 .. 999 kA
Power factor	PFA, PFV	0.5 (IEC61557-12)	0.00 .. 1.00	0.00 .. 1.00
Current harmonics	I_h	Cl. 1 (IEC61000-4-7)	1 .. 63	0 .. 999 kA
THD of the current	THDi	1.0 (IEC61557-12)	0 .. 999%	0 .. 999%

Function	Symbol	Accuracy class - 1 A nominal current	Measurement range	Display range
Total active power	P	0.5 (IEC61557-12)	0 .. 12.6 kW	0 .. 999 GW
Total reactive power	QA, Qv	1 (IEC61557-12)	0 .. 16.6 kvar	0 .. 999 Gvar
Total apparent power	SA, Sv	0.5 (IEC61557-12)	0 .. 12.6 kVA	0 .. 999 GVA
Total active energy	Ea	0.5 (IEC61557-12) 0.5S (IEC62053-22)	0 .. 999 GWh	0 .. 999 GWh
Total reactive energy	ErA, ErV	1 (IEC61557-12)	0 .. 999 Gvarh	0 .. 999 Gvarh
Total apparent energy	EapA, EapV	0.5 (IEC61557-12)	0 .. 999 GVAh	0 .. 999 GVAh
Phase current	I	0.5 (IEC61557-12)	0.005 .. 6 A_{eff}	0 .. 999 kA
Neutral conductor current calculated	INc	1.0 (IEC61557-12)	0.03 .. 25 A	0.03 .. 999 kA
Power factor	PFA, PFV	1 (IEC61557-12)	0.00 .. 1.00	0.00 .. 1.00
Current harmonics	I_h	Cl. 1 (IEC61000-4-7)	1 .. 63	0 .. 999 kA
THD of the current	THDi	1.0 (IEC61557-12)	0 .. 999%	0 .. 999%

19.3 Parameter and Modbus address list

INFORMATION

A standard Modbus address list with explanations of measured values and a formulary can be found in the download area at www.janitza.de.

19.4 Information on saving measured values and configuration data

INFORMATION

The device stores the following measured values every 5 minutes at the latest:

- S0 meter readings
- Min. / max. / average values
- Energy values (work values)

The device saves configuration data immediately (1-2 s)!

20. Dimensional drawings

- The figures are for illustration purposes only and are not to scale.
- All dimensions in mm (in).

Rear view

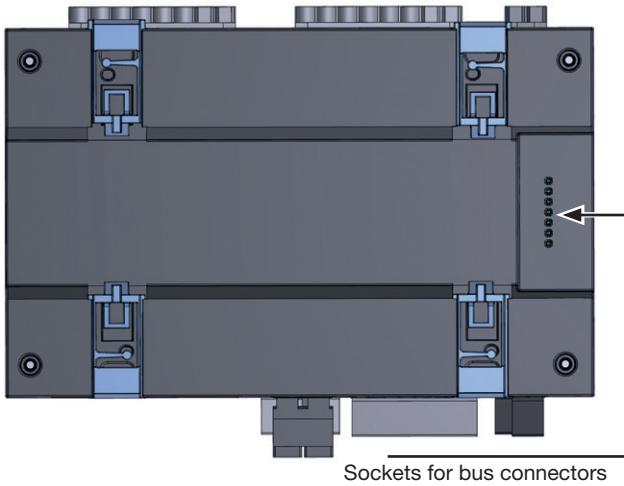

Bus connector

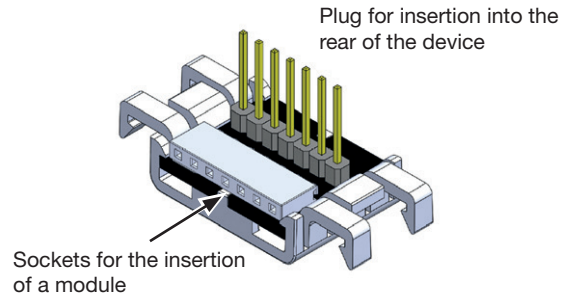

Bottom view

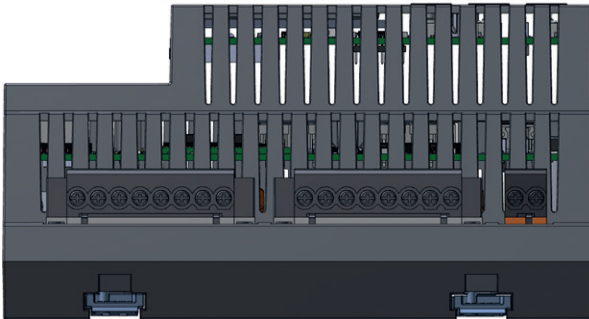

Top view

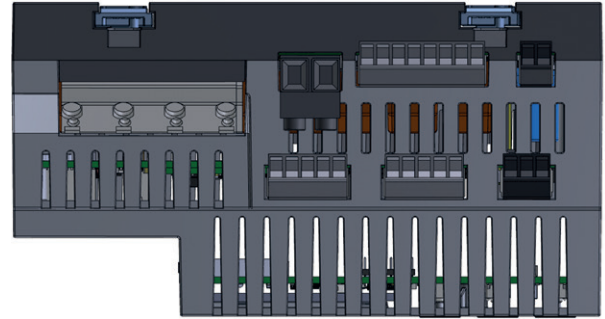

Front view

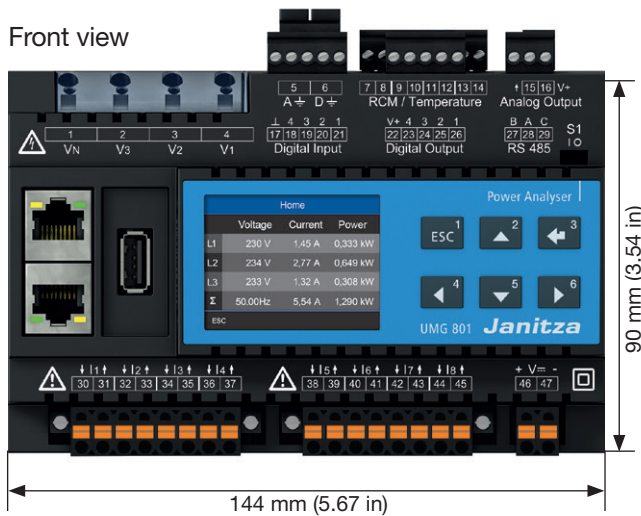

View from left

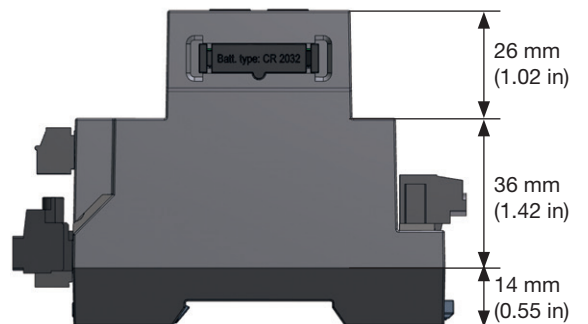

Janitza[®]

Janitza electronics GmbH
Vor dem Polstück 6
D-35633 Lahnau

Support tel. +49 6441 9642-22
Email: info@janitza.de
info@janitza.de | www.janitza.de