



Product designation	Miniature circuit breaker (MCB)
Product type designation	P1 MB
Number of poles	3P
Number of DIN modules	3
Compliance	IEC / UL1077

Electrical features			
Rated insulation voltage U_i IEC/EN	V		440
Rated impulse withstand voltage U_{imp}	kV		4
Rated operational voltage AC (IEC)	VAC		230/400
Rated frequency	Hz		50/60
Rated current (I_n)	A		1
Tripping curve			C
Short circuit rating (IEC)	kA		10
Electrical life	cycles		10000
Power dissipation per pole max	W		1.07

Ambient conditions			
Operating temperature	min	°C	-40
	max	°C	+70
Storage temperature	min	°C	-40
	max	°C	+80
Max altitude		m	2000

Mechanical features				
Operating position		normal	Vertical plan	
Fixing			35mm DIN rail	
Tightening torque for terminals	min	Nm	1.8	
	max	Nm	2	
	min	Ibin	16	
	max	Ibin	17.7	
Terminals tool			Pz 2	
Conductor section	IEC	min	mm ²	1
		max	mm ²	35
	AWG/Kcmil	min		14
		max		6
	Mechanical life		cycles	20000
	Weight		g	345
Frontal IP degree			IP20	
Pollution degree			2	

Dimensions

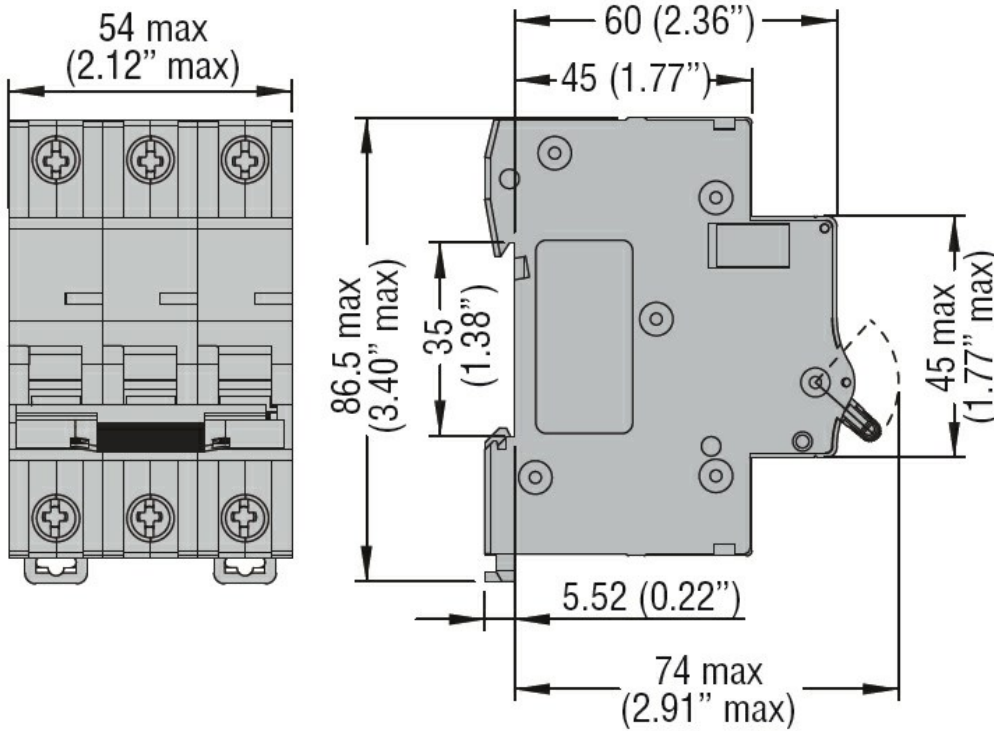

Wiring diagrams

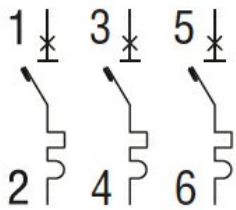

Certifications and compliance

Compliance

CSA C22.2 n°235. UR "UL Recognized" per Canada e USA.
IEC/EN 60898-1
IEC/EN 60947-2
UL 1077

Certifications

cURus
EAC
TÜV-Rheinland

ETIM classification

ETIM 8.0

EC000042 -
Miniature circuit
breaker (MCB)