

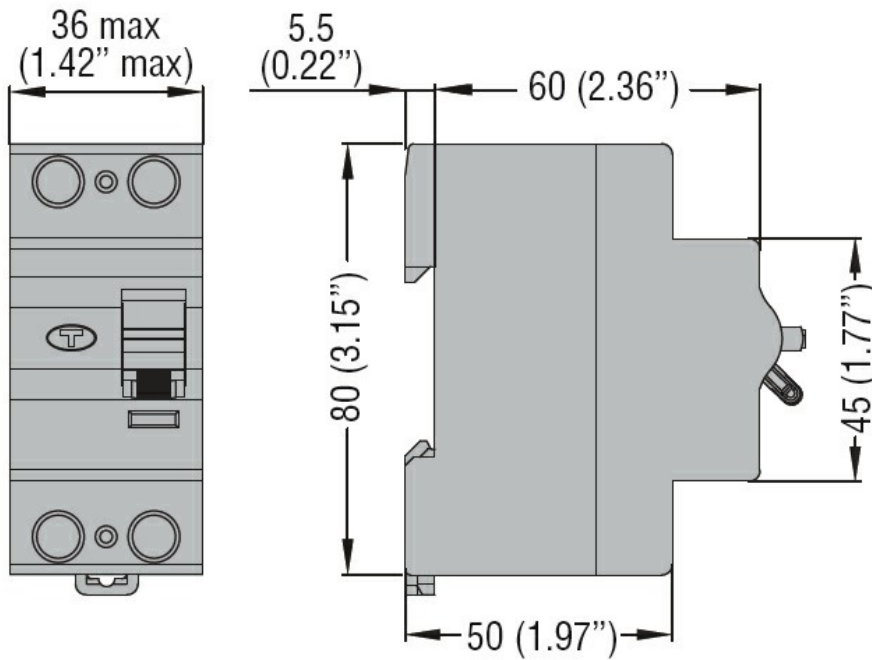

Product designation	Residual current circuit breakers (RCCB)			
Product type designation	P1 RC			
Number of poles	2P			
Number of DIN modules	2			
Compliance	IEC			
<b>Electrical features</b>				
Rated insulation voltage $U_i$ IEC/EN	V	400		
Rated impulse withstand voltage $U_{imp}$	kV	4		
Rated operational voltage AC (IEC)	VAC	230		
Rated frequency	Hz	50/60		
Rated current ( $I_n$ )	A	40		
Residual operation characteristic		AC		
Rated residual current	mA	30		
Power dissipation per pole max	W	1.6		
<b>Ambient conditions</b>				
Operating temperature	min	°C	-35	
	max	°C	70	
Storage temperature	min	°C	-40	
	max	°C	80	
Max altitude	m	2000		
<b>Mechanical features</b>				
Operating position	normal	Vertical plan		
Fixing		35mm DIN rail		
Tightening torque for terminals	min	Nm	1.8	
	max	Nm	2	
	min	lbin	16	
	max	lbin	17.7	
Terminals tool		Pz 2		
Conductor section	IEC	min	mm <sup>2</sup>	2.5
		max	mm <sup>2</sup>	35
	AWG/Kcmil	min		14
		max		2
Weight		g	185	
Frontal IP degree		IP20		
Pollution degree		2		
<b>Dimensions</b>				



**Certifications and compliance**

Compliance

IEC/EN/BS 61008-1

Certifications

EAC

TÜV-SUD

**ETIM classification**

ETIM 8.0

EC000003 -  
Residual current  
circuit breaker  
(RCCB)