



ORIENT

ORIENT ELECTRONICS

<http://www.orientelec.co.kr>

SPECIFICATIONS

Product.	Noise Filter	Date.	2012. 09. 19
Model.	TMS-5S	Rev.	A
Customer.	STANDARD	Page.	3 / 4

MODEL		Unit.	TMS-5006	TMS-5010	TMS-5020	TMS-5030
INPUT	Voltage	[V]	3 Φ , AC 500 or DC 500			
	Frequency	[Hz]	50 / 60			
	Rated Current *1)	[A]	6	10	20	30
Voltage Drop		[V]	0.3V Max			
Test voltage		[V]	2,500VAC (at cut off current 100mA / 1Min)			
Isolation Resistance		[M Ω]	100M Ω Min (500VDC / 1Min)			
Leakage Current (60Hz)	250V	[mA]	2.5mA Max			
	500V	[mA]	5.0mA Max			
DC Resistance (Max)		[m Ω]	290	120	50	26
Temperature Rise		[$^{\circ}$ C]	50 $^{\circ}$ C Max			
Environment	Operating temp. & Humidity	-	-25 ~ +85 $^{\circ}$ C, 20 ~ 95% RH (Refer to Derating Curve)			
	Storage temp. & Humidity	-	-40 ~ +85 $^{\circ}$ C, 20 ~ 95% RH (Non Condensing)			
	Vibration	-	10~55Hz at 2G 3minutes period, 1hour each X,Y and Z			
Dimension	Size(WxHxD)	[mm]	210*55*95		240*60*105	
	Weight(Typ)	[g]	910g		1,400g	
Safety Standards		-	Approved by standard UL1283, CSA C22.2 No.8(C-UL), IEC/EN60939-2			

비 고 :

- Derating Curve

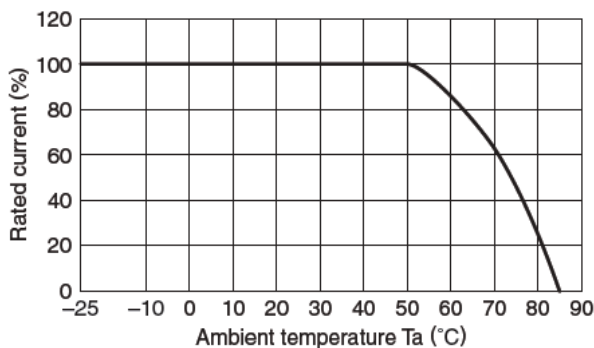

- Circuit Diagram

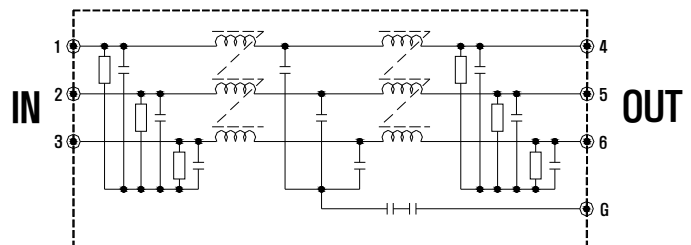

= NOTES =

*1. Value for Ta less than 50 $^{\circ}$ C

For Ta more than 50 $^{\circ}$ C, According to the derating curve as above

SPECIFICATIONS

Product.	Noise Filter	Date.	2012. 09. 19
Model.	TMS-5S	Rev.	A
Customer.	STANDARD	Page.	4 / 4

MODEL		Unit.	TMS-5040	TMS-5050	TMS-5060
INPUT	Voltage	[V]	3 Φ , AC 500 or DC 500		
	Frequency	[Hz]	50 / 60		
	Rated Current *1)	[A]	40	50	60
Voltage Drop		[V]	0.3V Max		
Test voltage		[V]	2,500VAC (at cut off current 100mA / 1Min)		
Isolation Resistance		[M Ω]	100M Ω Min (500VDC / 1Min)		
Leakage Current (60Hz)	250V	[mA]	2.5mA Max		
	500V	[mA]	5.0mA Max		
DC Resistance (Max)		[m Ω]	20	14	10
Temperature Rise		[$^{\circ}$ C]	50 $^{\circ}$ C Max		
Environment	Operating temp. & Humidity	-	-25 ~ +85 $^{\circ}$ C, 20 ~ 95% RH (Refer to Derating Curve)		
	Storage temp. & Humidity	-	-40 ~ +85 $^{\circ}$ C, 20 ~ 95% RH (Non Condensing)		
	Vibration	-	10~55Hz at 2G 3minutes period, 1hour each X,Y and Z		
Dimension	Size(WxHxD)	[mm]	278 * 70 * 128		
	Weight(Typ)	[g]	2,800g		
Safety Standards		-	Approved by standard UL1283, CSA C22.2 No.8(C-UL), IEC/EN60939-2		

비 고 :

- Derating Curve

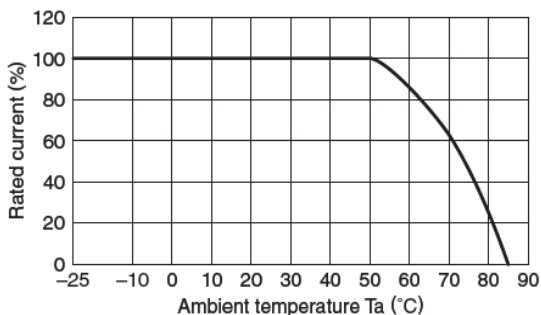

- Circuit Diagram

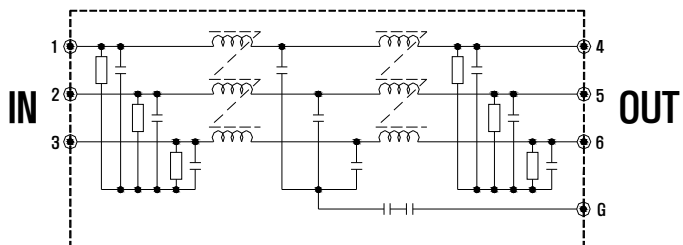

= NOTES =

- *1. Value for Ta less than 50 $^{\circ}$ C
For Ta more than 50 $^{\circ}$ C, According to the derating curve as above

User Guide

1. INSTALLATION CONDITION

1-1. NOISE FILTER 결선

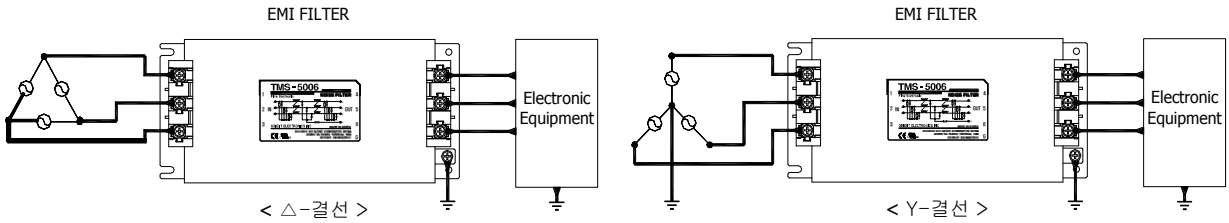

1-2. Terminal Connection

Marking	Pin Connection		Function
1	INPUT	AC R상	Noise Filter AC 입력 Terminal
2		AC S상	
3		AC T상	
4	OUTPUT	AC R상	Noise Filter AC 출력 Terminal
5		AC S상	
6		AC T상	
G	Flame ground		CASE 접지

1-3. Applicable Electric Cable

허용전류(A)	최소 선경	
	단면적(mm ²)	AWG SIZE
6	0.75	18
10	1.0	16
16	1.5	14
20	2.5	12
30	4.0	10
40	6.0	8
50	10.0	6
60	10.0	6

1-4. Recommended Clamping Torque

Screw	Torque	비고
M4	1.27N·m	
M5	2.50N·m	

2. ELECTRICAL CHARACTERISTICS

2-1. Rated Voltage : 3상, 250VAC or 500VAC

2-2. Rated Current

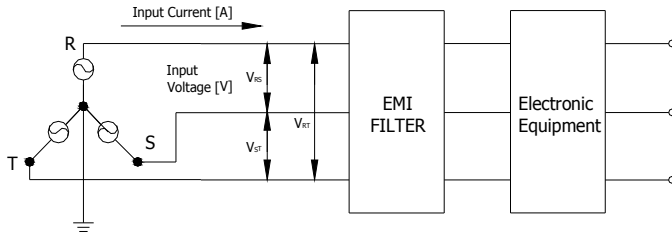

$$\text{Input Current [A]} = \frac{\text{Input Capacity of the Equipment [VA]}}{\text{Input Voltage [V]} \times \sqrt{3}}$$

$$\text{Rated Current [A]} \geq \text{Input Current [A]}$$

2-3. Withstand Voltage Test

AC 입, 출력과 접지간 절연내압이 AC 2500V에서 1분간 Current 100mA 이하이다.

2-4. Isolation Resistance Test

AC 입, 출력과 접지간 절연저항이 DC 500V에서 1분간 100MΩ이상이다.

2-5. Leakage Current Test

Input Voltage	Leakage Current	Note
0 ~ 250VAC	2.5mA Max	입력 전압 인가시 LINE-GND간 최대 누설전류량
251 ~ 500VAC	5.0mA Max	

3. ENVIRONMENT CONDITION

3-1. Operating Temperature Test

아래의 온, 습도에서 정격입출력 상태로 8시간 운영 시험에서 제반 전기적 특성 및 기구적 특성을 만족하여야 한다.

(1) 온도 : -25℃ ~ +85℃

(2) 상대습도 : 20 ~ 90% RH

3-2. Heat Cycle Test

주위온도 -40℃ ~ +85℃에서 아래의 Cycle을 기준으로 50Cycle 후 제반 전기적 특성 및 기구적 특성을 만족하여야 한다.

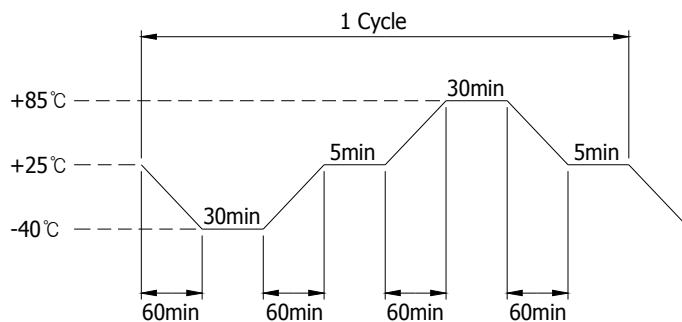

3-3. Vibration Test

아래의 진동 조건에 따라 1시간 진동 시험 후 제반 전기적 특성 및 기구적 특성을 만족하여야 한다.

(1) Vibration Frequency : 10~55Hz, 2G

(2) Vibration Period : 3minutes

4. ORDERING INFORMATION

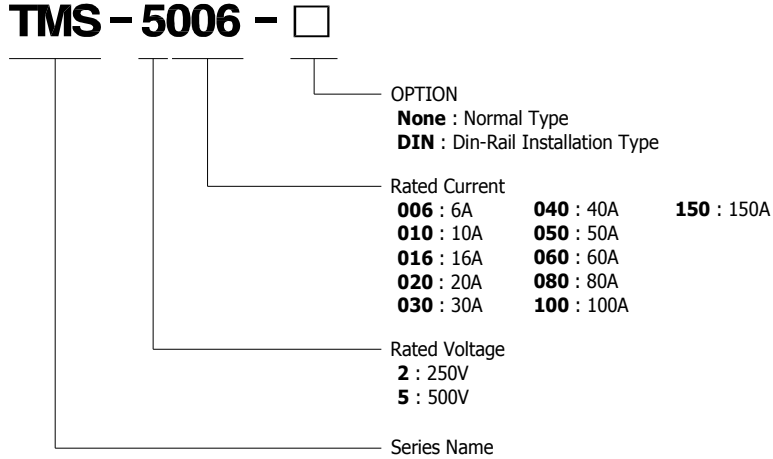

5. 사용시 주의 사항

- 5-1. 제품에 명시된 허용 전압, 허용 전류, 사용온도조건에 맞게 사용한다.
- 5-2. Noise Filter와 연결하는 단자 및 케이블은 제품 허용 전압/전류 이상의 것을 사용한다.
- 5-3. 접지시 케이블을 가능한한 굵고 짧게 사용한다.
- 5-4. 제품의 입출력 단자 체결시 무리한 힘을 가하여 파손되지 않도록 주의한다.
- 5-5. 제품 설치 및 사용시 상간 단락이 되지 않도록 주의한다.
- 5-6. 통전 중에는 단자부위에 손이나 기타 신체부위가 접촉되지 않도록 주의한다.

6. 품질 보증

- 6-1. 계약자는 계약상 별도로 규정하지 않은 본 규격서에 명시된 모든 성능과 특성을 자체 또는 공인 시험 기관의 검사 시설을 이용하여 시험검사를 할 수 있다.
- 6-2. 본 규격서 상에서 규정한 필요조건에 대한 확인 검사 이외에 제품의 품질을 확인하기 위하여 필요한 검사를 할 수 있다.

7. 주 기

- 7-1. 본 규격서 상에 명시되지 않은 사항은 본 품의 신뢰도와 호환성 및 성능에 지장이 없는 범위 내에서만 이를 허용한다.

Attenuation Characteristics

1. METHOD OF MEASURING ATTENUATION

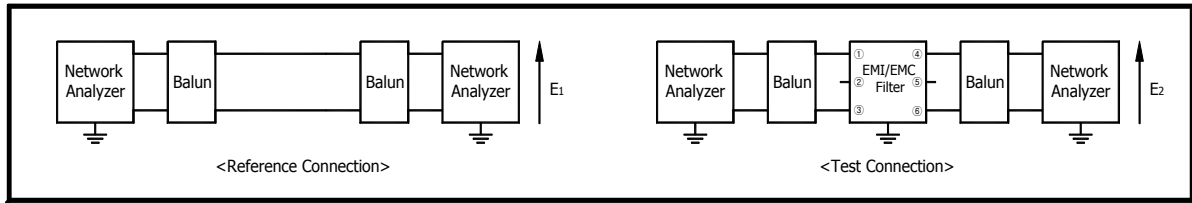

Fig.3.1 Differential Mode Attenuation Measurement Diagram

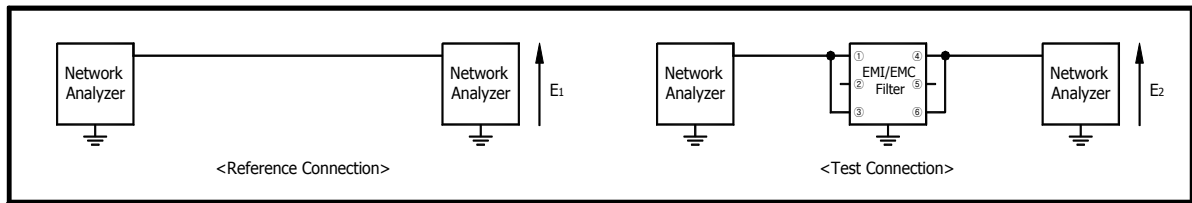
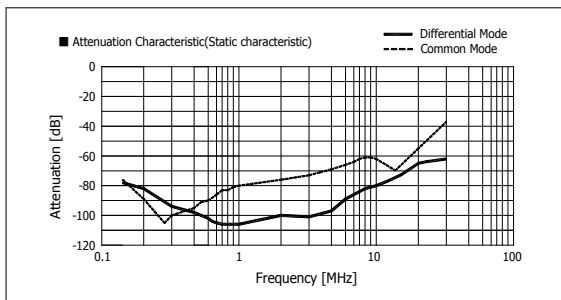

Fig.3.2 Common Mode Attenuation Measurement Diagram

2. ATTENUATION CHARACTERISTICS

2-1. TMS-Series (Rated Current : 6~30A)

TMS-5006



TMS-5010

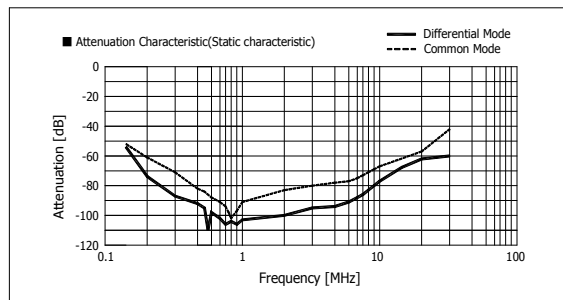

TMS-5020

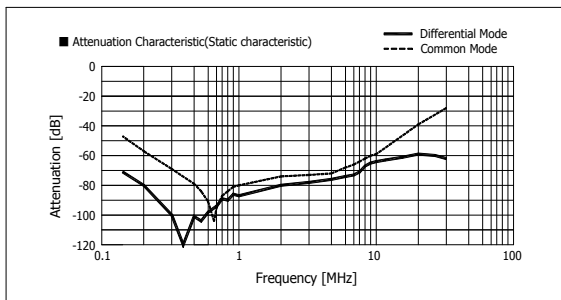

TMS-5030

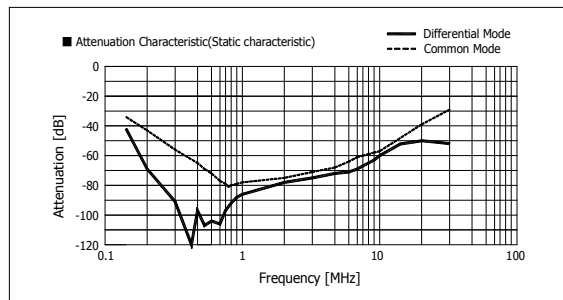

Attenuation Characteristics

2-2. TMS-Series (Rated Current : 40~60A)

TMS-5040

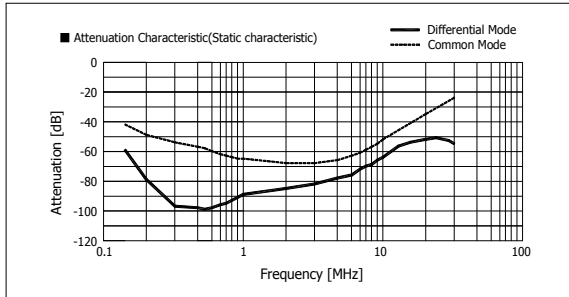

TMS-5050

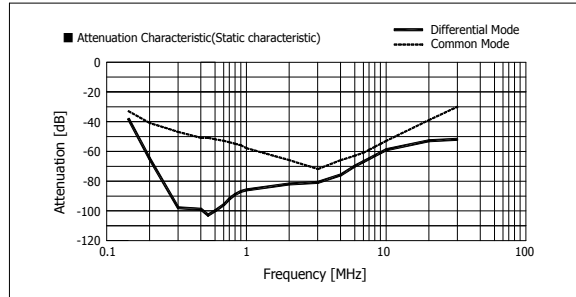

TMS-5060

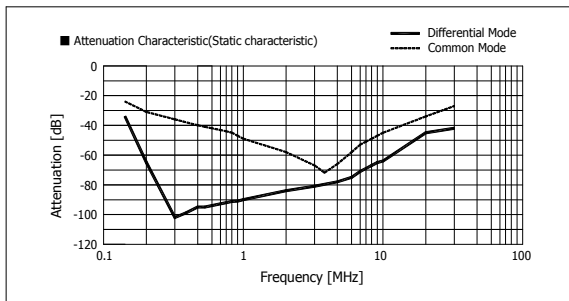

■ Attenuation[dB] = $-20\log(E_1/E_2)$

E₁ = Voltage in state without filter
 E₂ = Voltage in state with filters

Dimension

TMS-5006/5010

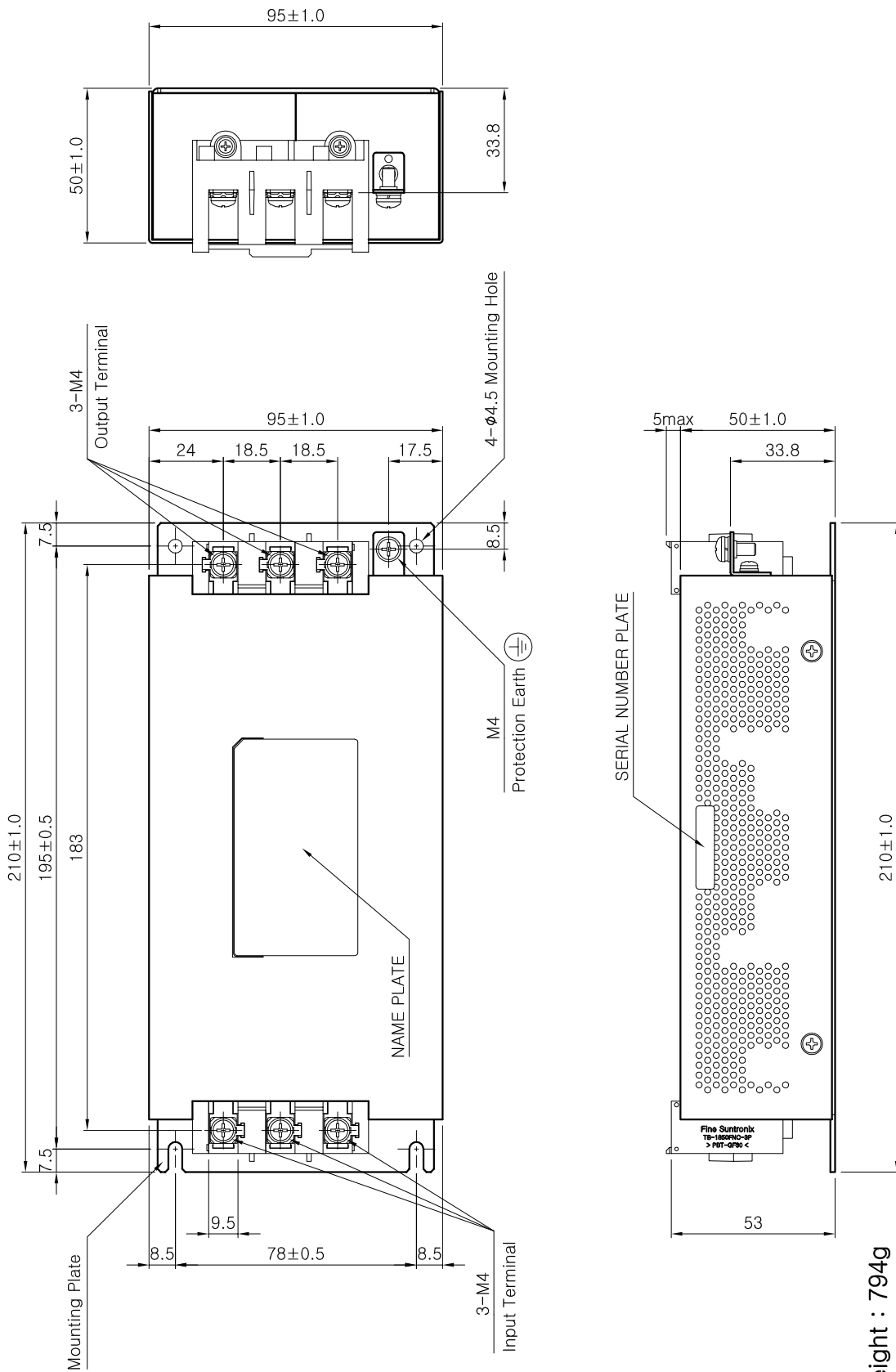

- * Weight : 794g
- * Tolerance : ± 1
- * Dimensions in mm

Dimension

TMS-5020/5030

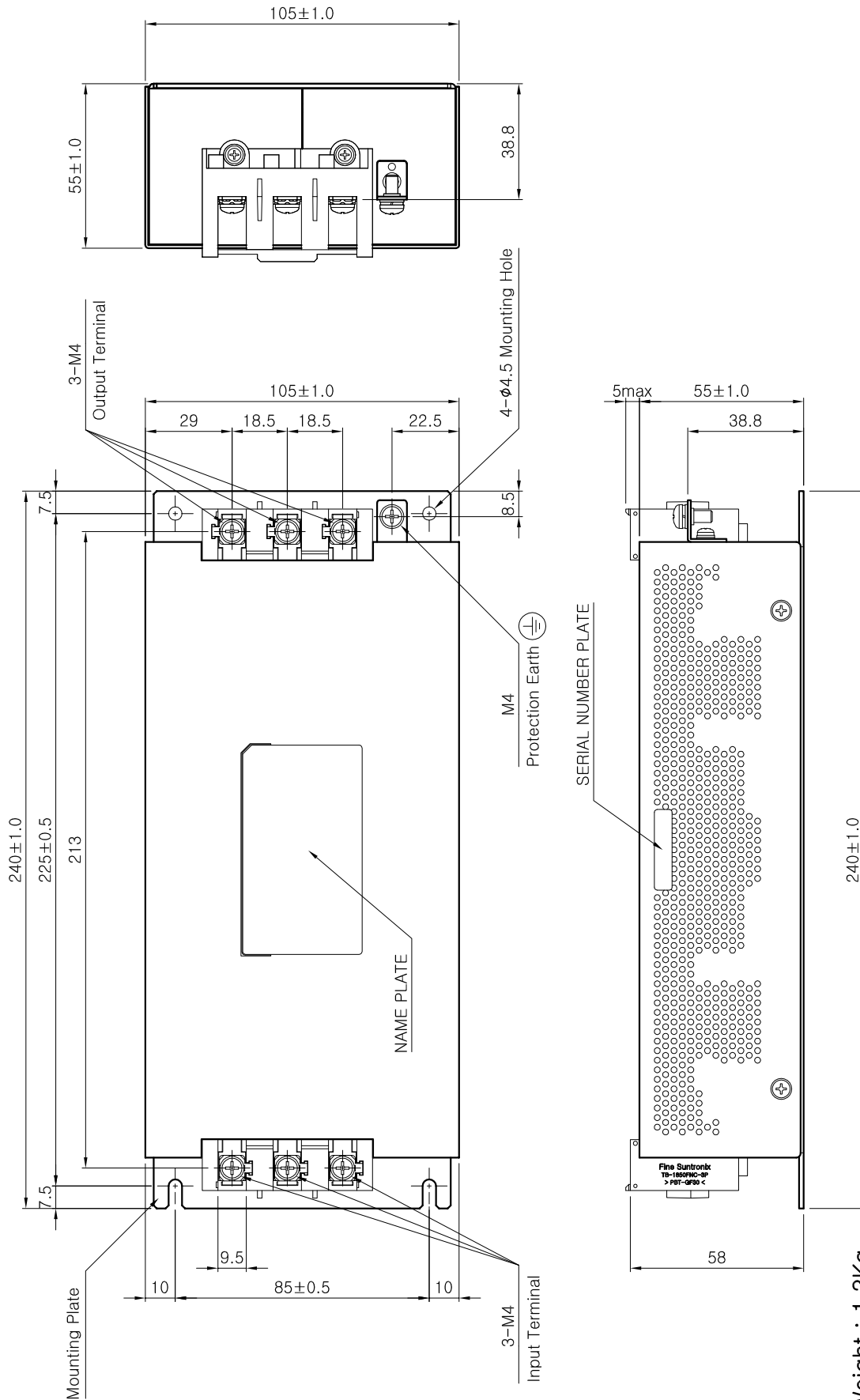

- * Weight : 1.3Kg
- * Tolerance : ± 1
- * Dimensions in mm

Dimension

TMS-5040/5050/5060

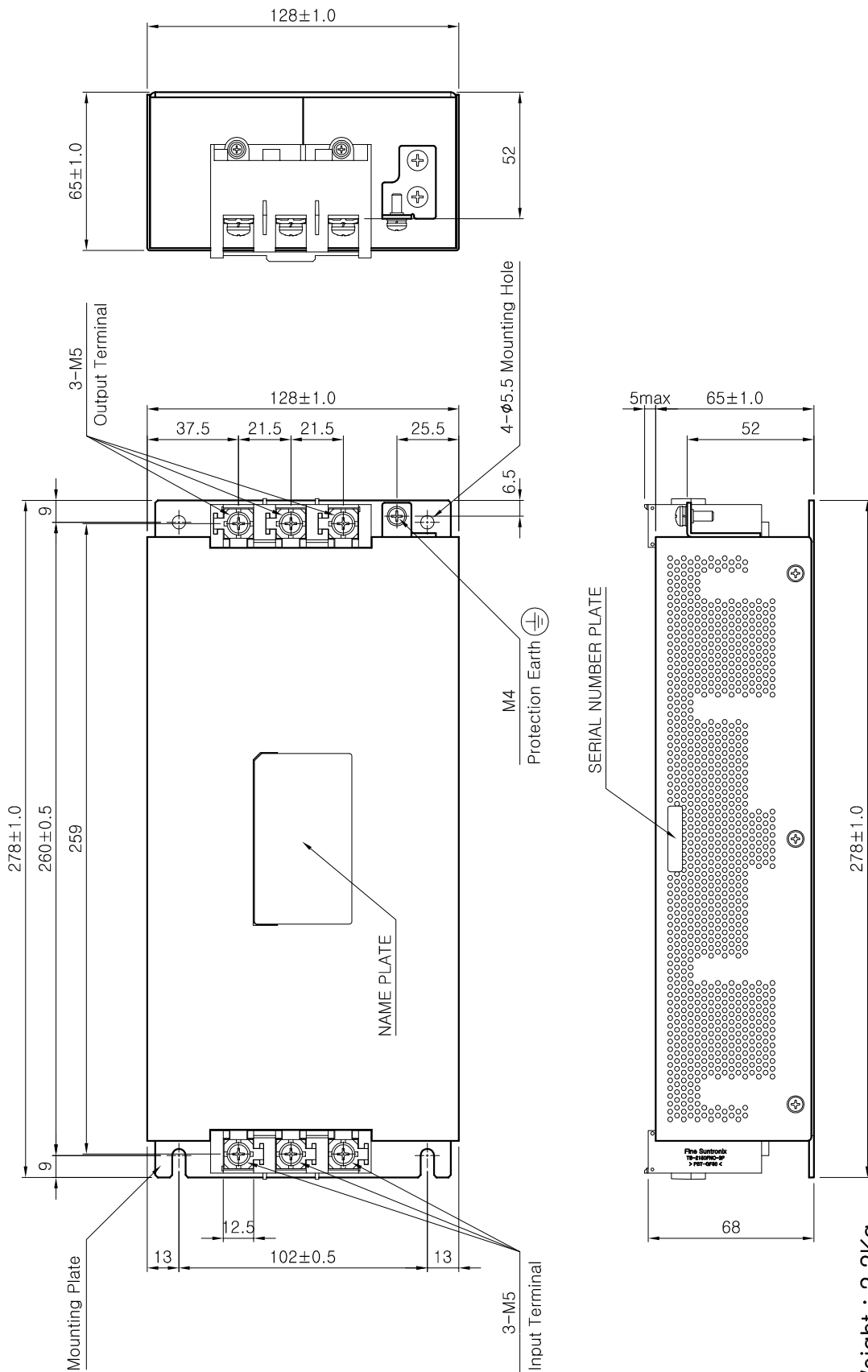

* Weight : 2.2Kg

* Tolerance : ± 1

* Dimensions in mm

www.orientelec.co.kr

Orient Electronics Inc.

143-1, Sangdaewon-Dong, Jungwon-Gu, Seongnam-Si, Gyeonggi-Do, Korea

Head office & Factory

Telephone +82-31-737-0200 Telefax +82-31-737-0233

()

143-1

: 031-737-0200

: 031-737-0233

ORIENT ELECTRONICS