





72 x 72mm

Features:

- Analog style bargraph indication
- True RMS measurement
- CT primary programable up to 5000A
- For 3 phase 4 wire electrical connection
- Page selection using selector switch

Certifications:  

Display Specifications

Display	Single row, Liquid Crystal Display
Digits	4
Digit Height	0.56" (14.2mm)
Display Range	0 – 6200A
Bargraph	Analog style bargraph indication

Input Specifications

Electrical Connection	3Ø- 4 wire
Input Type	AC
Input Current Range	50mA - 5A
Continuous Max. Input Rating	6.2A
Overrange Indication	"Or" for input > 6.2A
Frequency	50 / 60Hz
Resolution	0.001, 0.01, 0.1, 1A (Depending upon CT Primary Setting)
Accuracy	±0.5% of CT Primary Setting
Burden	0.5 VA per phase at 5 A
Sampling Rate	3 samples / second
Dielectric withstand Voltage	2kV AC between auxiliary supply & measuring input
Rated Impulse withstand Voltage	2kV (1.2/50µS)

Auxiliary Supply Specifications

Auxiliary Supply	240V AC ±20%, (50 / 60Hz) 110V AC ±20%, (60Hz)
Power Consumption	12VA max

Settable Parameters

CT Primary Settings	5, 10, 15, 20, 25, 30, 40, 50, 60, 75, 80, 100, 125, 150, 175, 200, 250, 300, 400, 500, 600, 630, 750, 800, 1000, 1200, 1500, 1600, 2000, 2250, 2500, 3000, 3200, 4000, 5000.
CT Secondary Settings	5A Fixed

Environmental Specifications

Temperature	Operating: -10 to +55°C (14 to 131°F) Storage: -20 to +75°C (-4 to 167°F)
Humidity (non-condensing)	Upto 95% RH

Mechanical Specifications

Mounting	Panel mount
Weight	163 gms

Compliance

Applicable EMI / EMC Standards		
Product Standard : IEC 61326-1		
Category		Standards Compliance
ESD Immunity	IEC 61000-4-2	Level IV (Air discharge : 15kV), (Contact Discharge : -8kV)
Surge Immunity	IEC 61000-4-5	+/- 2kV common mode, (Line to ground) +/- 1kV differential mode, (Line to Line)
Radiated Susceptibility	IEC 61000-4-3	Level III, 80 to 1000MHz (10V/m) Level II, 1.4GHz to 2GHz (3V/m) Level I, 2GHz to 2.7GHz (1V/m)
Conducted Susceptibility	IEC 61000-4-6	Level II (3V/m)
Voltage Dips and Interruptions	IEC 61000-4-11	Dips : 0% residual voltage / 1 cycle (Criteria B), 40% residual voltage / 10 cycles 50Hz / 12 cycles 60Hz (Criteria C) 70% residual voltage / 25 cycles 50Hz / 30 cycles 60Hz (Criteria C) Interruptions : 0% residual voltage / 250 cycles 50Hz / 300 cycles 60Hz (Criteria C)
Conducted Emission	CISPR-11	
Radiated Emission	CISPR-11	
Electrical Fast Transient	IEC 61000-4-4	Level III (2kV)

Dimensions

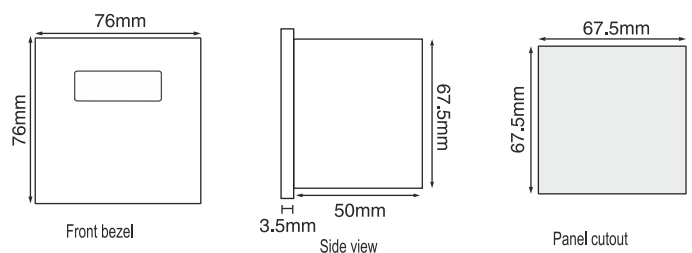

Terminal Connections

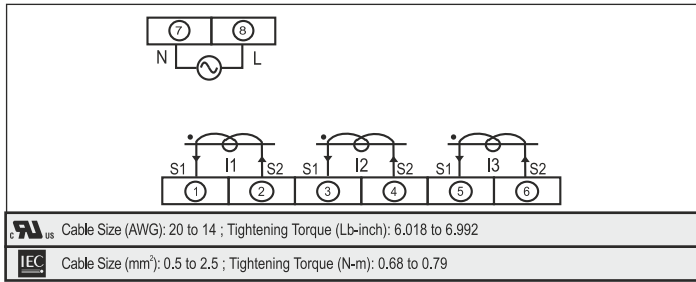

Ordering Information

Part No.	Supply Voltage		Certification	
	110V AC	240V AC	CE	UL LISTED
MA2301		■		
MA2301-230V-CE		■	■	
MA2301-110V-CU	■		■	■

Note: CT Type-There is an internal CT with CT setting (5-5000A). For current input >5A, external CT is required.



SPECIFICATIONS

AC MODEL (CT INPUT)						
Product Name	MA12	MA202	MA302	MA501	MA201	MA2301
Description	1 Ø Digital Ammeter			3 Ø Digital ammeter		
Display	4 digit 7 segment LED display			4 digit LCD with analog style bargraph indication		
Display range	0 to 4960A			0 to 6200A		
Input range	50mA to 5A AC					
Input Frequency	50 / 60Hz					
Max continuous Input range	6.2A					
Over range indication	"Or" for input > 6.2A					
CT primary setting	5 to 4000 (programmable in steps)			5 to 5000 (programmable in steps)		
CT secondary setting	5A fixed					
Resolution	0.001, 0.01, 0.1, 1A (depending upon CT primary setting)					
Electrical connection	1 Ø - 2 wire			3 Ø - 4 wire		
Supply Voltage	240V AC (± 20%), 50 / 60Hz ; 110V AC (± 20%), 60Hz					
Power consumption	5VA max.			12VA max.		
Weight	170gm	180gm	180gm	113gm	138gm	163gm
CE and UL Certification	YES	YES	CE ONLY	YES	YES	YES

DC MODEL (SHUNT / DIRECT INPUT)						AC MODEL (AUTO RANGING TYPE)	
Product Name	MA12-50mV-DC MA12-75mV-DC MA12-100mV-DC	MA12-DC-2mA	MA12-DC-20mA	MA12-DC-200mA	MA12-DC-2A	MA12-AC-2 / 20mA	MA12-AC-200 / 2000mA
Description	1 Ø Digital Ammeter						
Display	4 Digit 7 Segment LED Display	3 ½ digit 7 Segment LED Display					
Display range	0 to 4960A	-1.999mA to +1.999mA	-19.99mA to +19.99mA	-199.9mA to +199.9mA	-1999mA to +1999mA	0 to 1.999 / 19.99mA	0-199.9 / 1999mA
Input range	MA12-50mV DC : 0 to 50mV MA12-75mV DC : 0 to 75mV MA12-100mV DC : 0 to 100mV	0 to ±2mA	0 to ±20mA	0 to ±200mA	0 to ±2000mA	0 to 2/20mA	0 to 200/ 2000mA
Input Frequency	50 / 60Hz						
Measurement range	0 to 6.2A	0 to ±1.999mA	0 to ±19.99mA	0 to ±199.9mA	0 to ±1999mA	0 to 19.99mA	0 to 1999mA
Max continuous Input range	6.2A	±1.999mA	±19.99mA	±199.9mA	±1999mA	1.999 / 19.99mA	199.9 / 1999mA

DC MODEL (SHUNT / DIRECT INPUT)						AC MODEL (AUTO RANGING TYPE)	
Product Name	MA12-50mV-DC MA12-75mV-DC MA12-100mV-DC	MA12-DC-2mA	MA12-DC-20mA	MA12-DC-200mA	MA12-DC-2A	MA12-AC-2 / 20mA	MA12-AC-200 / 2000mA
Over range Indication	"Or" for input > 6.2A	"Or" for input > ±1.999mA	"Or" for input > ±19.99mA	"Or" for input > ±199.9mA	"Or" for input > ±1999mA	"Or" for input > 19.99mA	"Or" for input > 1999mA
Shunt setting	5 to 4000						
Resolution	0.001, 0.01, 0.1, 1A (depending upon shunt setting)	0.001	0.01	0.1	1	0.001/0.01	0.1/1
Electrical connection	1 Ø - 2 wire						
Power consumption	5VA max.						
Supply Voltage	240V AC (± 10%), 50 / 60Hz ; 110V AC (± 10%), 60Hz						
Input type	Shunt	Direct					
Weight	170gm	170gm	170gm	170gm	170gm	170gm	170gm
CE and UL Certification	YES	YES	YES	YES	YES	YES	YES

- Accuracy** : ± 0.5% of full scale
- Measurement Method** : True RMS
- Sampling Rate** : 3 samples / second
- Burden** : 0.5VA at 5A AC (CT input)
- Environmental Conditions**
 - Temperature : Operating : -10°C to 55°C
Storage : -20°C to 75°C
 - Humidity : Up to 95% RH (non condensing)
 - Altitude : Up to 2000 meters
 - Pollution degree : II
- Installation Category** : II (300V)
- Protection Class** : II
- Mounting** : Panel mounting

Ordering Information

Note : For CE and UL certified product, Add-CE ; -CU suffix to order code.
For example MA12-CU ; MA302-CE
For 110V Supply add -110V in order code
For example MA12-110V-CU ; MA302-110V-CE

WIRING GUIDELINES

WARNING

1. To prevent the risk of electric shock, power supply to the equipment must be kept OFF while doing the wiring arrangement.
2. Wiring shall be done strictly according to the terminal layout. Confirm that all connections are correct.
3. Use lugged terminals.
4. To reduce electromagnetic interference use of wires with adequate ratings and twists of the same in equal size shall be made with shortest connections.
5. Layout of connecting cables shall be away from any internal EMI source.
6. Cable used for connection to power source, must have a cross section of 0.5mm² to 2.5mm² (20 to 14AWG; 75°C(min)). These wires shall have current carrying capacity of 6A.
7. Copper cable should be used (Stranded Or Single core cable)
8. Before attempting work on device, ensure absence of voltages using appropriate voltage detection device.

INSTALLATION GUIDELINES

CAUTION

1. This equipment, being built-in-type, normally becomes a part of main control panel and in such case the terminals do not remain accessible to the end user after installation and internal wiring.
2. Conductors must not come in contact with the internal circuitry of the equipment or else it may lead to a safety hazard that may in turn endanger life or cause electrical shock to the operator.
3. Circuit breaker or mains switch must be installed between power source and supply terminals to facilitate power 'ON' or 'OFF' function. However this switch or breaker must be installed in a convenient position normally accessible to the operator.
4. Before disconnecting the secondary of the external current transformer from the equipment, make sure that the current transformer is short circuited to avoid risk of electrical shock and injury.
5. The equipment shall not be installed in environmental conditions other than those mentioned in this manual.
6. The equipment does not have a built-in-type fuse. Installation of external fuse of rating 275V AC / 0.5Amp for electrical circuitry / battery is highly recommended.

SAFETY PRECAUTIONS

All safety related codifications, symbols and instructions that appear in this operating manual or on the equipment must be strictly followed to ensure the safety of the operating personnel as well as the instrument.

If the equipment is not used in a manner specified by the manufacturer it might impair the protection provided by the equipment.

- Do not use the equipment if there is any mechanical damage.
- Ensure that the equipment is supplied with correct voltage.

CAUTION

1. Read complete instructions prior to installation and operation of the unit.
2. Risk of electric shock.
3. The equipment in its installed state must not come in close proximity to any heating sources, caustic vapors, oils, steam, or other unwanted process by products.

MECHANICAL INSTALLATION

For installing the meter

1. Prepare the panel cutout with proper dimensions as shown below.

	Outline Dimensions (in mm)		Panel cutout Dimensions (in mm)	
MA12				
MA501				
MA20XX				
MA302				

2. Push the meter into the panel cutout. Secure the meter in its place by pushing the clamp on the rear side. The clamps must be secured in diagonally opposite slots.
3. For proper sealing, tighten the screws evenly with required torque.
Terminal screw tightening torque :
0.68 N-m to 0.79 N-m (6.018 In-Lb to 6.992 In-Lb)
Screw clamp tightening torque : 0.1N-m (0.885 Lb-inch)

MAINTENANCE

1. The equipment should be cleaned regularly to avoid blockage of ventilating parts.
2. Clean the equipment with a clean dry or damp cloth.
Do not use any cleaning agent other than water.

TERMINAL CONNECTIONS

MA12-AC / MA302	AC MODELS (CT INPUT)	
	AC MODELS (DIRECT INPUT)	
MA12-DC	DC MODELS (SHUNT INPUT)	
	DC MODELS (DIRECT INPUT)	

MA501	
MA201	
MA2301	
MA202	

WIRING DIAGRAM

Case for MA12 AC Models (CT Input) / Case for MA302

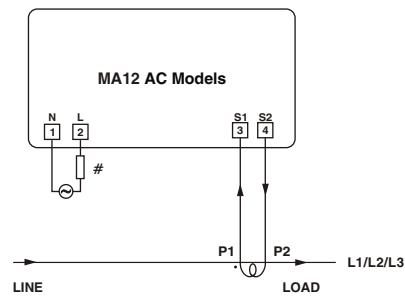

Case for MA12 AC Models (Direct Input)

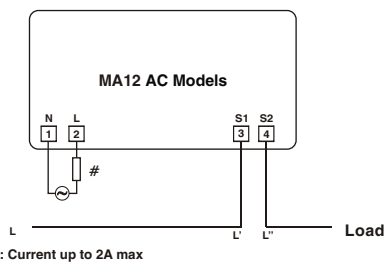

Case for MA12 DC Models (Shunt Input)

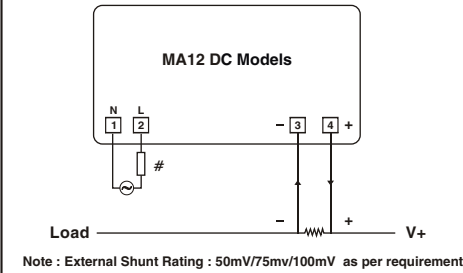

Case for MA12 DC Models (Direct Input)

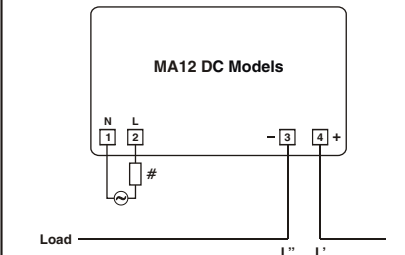

Case for MA2301

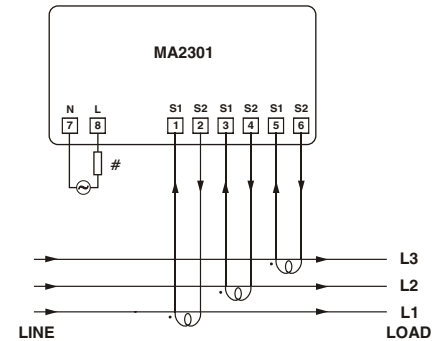

Case for MA201

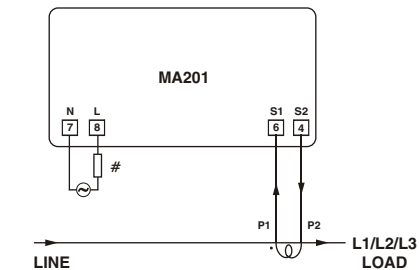

Case for MA501

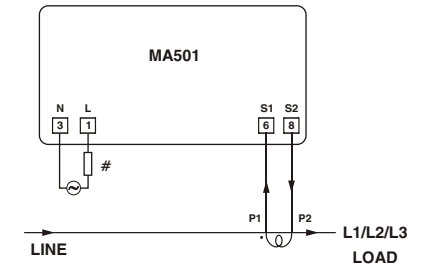

Case for MA202

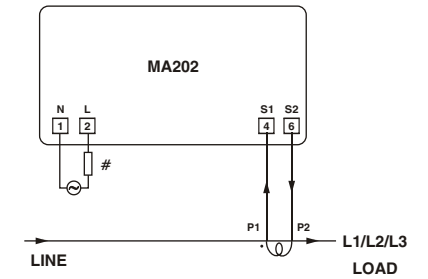

All fuse types : 0.5A class CC UL type ; 0.5A fast acting 600V

NOTE :

To enter into configuration mode : Press (●) switch for 5sec. after which,

- 1) For CT type models : "ctr" will be displayed initially.
CT settings can be done in steps with every press of the tact key at rear side of the product.
- 2) For shunt type models : "prg" will be displayed initially.
Shunt settings can be done in steps with every press of the tact key at rear side of the product.
CT / Shunt settings : 5, 10, 15, 20, 25, 30, 40, 50, 60, 75, 80, 100, 125, 150, 175, 200, 250, 300, 400, 500, 600, 630, 750, 800, 1000, 1200, 1500, 1600, 2000, 2250, 2500, 3000, 3200, 4000, 5000
(Note : The settings highlighted above are available only in MA201 / MA2301 / MA501)

To exit from configuration mode : switch OFF the unit and then switch ON or the unit will Auto Exit after 100sec. if no key is pressed.

Page scrolling can be done through different phase current pages with every press of the selector switch in MA2301.

(Specifications subject to change as development is a continuous process.)

Selec Controls Pvt. Ltd., India

Factory Address :

EL-27/1, Electronic Zone, TTC Industrial Area,
MIDC, Mahape, Navi Mumbai - 400 710, INDIA.
Tel. No. : +91-22-28476443 / 1882
Fax No. : +91-22-28471733 | Toll free : 1800 227 353
Website: www.selec.com | Email: sales@selec.com