

# Electronic Timer - Series Micon® 225 Signal Based Multi - Function

- Multi-function with Signal Start and Supply Start.
- 16 Timing Functions selected by DIP switch.
- Two independent relay outputs with either both relays timed or one timed and one instantaneous.
- Wide Input Signal & Supply range - 24-240V AC/DC.
- Wide Timing Range - 0.1 s to 120 days.
- High timing Accuracy.
- LED indicators for Power Supply & Relay Status.
- 22.5mm DIN Mount Housing.



## Ordering Information

Cat. No.	Description
2A8DT6	24-240 VAC / DC, Signal Based Multi - Function, 1 C/O (Delayed) & 1 C/O (Configurable as either Delayed or Instant)

# Electronic Timer - Series Micon® 225

## Signal Based Multi - Function



Cat. No.		2A8DT6
<b>Parameters</b>		
Timer Description		<b>Multi-function with Signal Start and Supply Start</b>
Supply Voltage (ϕ)		24-240 VAC / DC
Supply Variation		- 20% to +10% (of ϕ)
Frequency		50/60 Hz
Power Consumption (Max.)		3 VA
Initiate Time		100 ms (Max.)
Reset Time		200 ms (Max.)
Signal Voltage	Low Range (B1L-A2)	24-60V AC/DC
	High Range (B1H-A2)	85-265V AC, 100-265V DC
Signal Sensing Time		For AC Signals: 50 ms Max. For DC Signals: 20 ms Max.
Signal stabilization Delay		100 ms (Applicable at Power ON Only)
Setting Accuracy		± 5% of Full scale
Repeat Accuracy		± 1%
Output	Relay Output	1 C/O (Delayed) & 1 C/O (Configurable as either Delayed or Instant)
	Contact Rating	5A @ 240 VAC / 28 VDC (Resistive)
	Contact Material	AgNi
	Electrical Life	1x10 <sup>5</sup>
	Mechanical Life	1x10 <sup>7</sup>
Set Time (Ts)		0,1 seconds to 120 Days
Functions		Refer page no. 28 & 29
LED Indication on front panel		Green LED ON: Power ON, Amber LED ON :Relay ON for Delayed contact
Mounting		Base / DIN Rail
Max. Operating Altitude		2000 m
Housing		Flame retardant (UL 94-V0)
Operating Temperature		-10°C to +60°C
Storage Temperature		-20°C to +70°C
Humidity (Non Condensing)		95% (Rh)
LED Indication		Green LED → Power ON, Red LED → Relay ON
Enclosure		Flame Retardant UL94-V0
Dimension (W x H x D) (in mm)		22.5 X 83 X 100.5
Weight (unpacked)		130 g
Pollution Degree		II
Certification		  
Degree of Protection		IP 20 for Terminals, IP 40 for Enclosure

### EMI / EMC

Harmonic Current Emissions	IEC 61000-3-2
ESD	IEC 61000-4-2
Radiated Susceptibility	IEC 61000-4-3
Electrical Fast Transients	IEC 61000-4-4
Surges	IEC 61000-4-5
Conducted Susceptibility	IEC 61000-4-6
Voltage Dips & Interruptions (AC)	IEC 61000-4-11
Conducted Emission	CISPR 14-1
Radiated Emission	CISPR 14-1

### Safety:

Test Voltage between I/P and O/P	IEC 60947-5-1
Test Voltage between all terminals & enclosure	IEC 60947-5-1
Impulse Voltage between I/P and O/P	IEC 60947-5-1
Single Fault	IEC 61010-1
Insulation Resistance	UL 508
Leakage Current	UL 508
Product Reference Standard	IEC 61812-1

### Environmental

Cold Heat	IEC 60068-2-1
Dry Heat	IEC 60068-2-2
Vibration	IEC 60068-2-6
Repetitive Shock	IEC 60068-2-27
Non-Repetitive Shock	IEC 60068-2-27



# Electronic Timer - Series Micon® 225

## Signal Based Multi - Function

### FUNCTIONAL DIAGRAMS

⏻ : Supply Voltage, S: Input Signal, R: Relay Output, R(I): Instant Relay, R(D): Delayed Relay  
 T: Preset Time, TON: Preset ON Time, TOFF: Preset OFF Time, T-a: Timing Break Before completion

#### ON DELAY (Non Signal Based)

When supply is applied, timing starts and after the preset time duration 'T', output switches ON and remains ON till the supply is present.

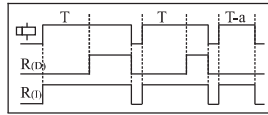

#### SIGNAL ON DELAY TYPE 1

When the input supply & signal are applied, timing starts and after preset time duration 'T' output switches ON & remains ON till the supply is present. Changing the state of signal during 'T' does not affect the output.

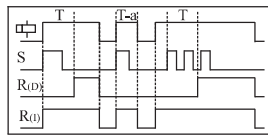

#### SIGNAL ON DELAY

Time commences as supply and signal is present. When input signal is opened, the timing resets. The output is switched ON at the end of the preset time duration 'T'. When output is ON if signal is opened then the output switches OFF.

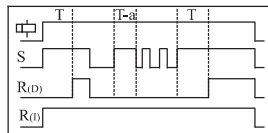

#### INVERTED SIGNAL ON DELAY

When supply is applied and signal is opened, preset time duration 'T' starts. On completion of the 'T', output switches ON. If the signal is closed during timing 'T', timing resets.

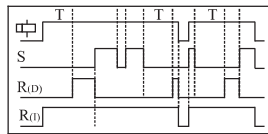

#### INTERVAL

When supply voltage is applied & signal is closed, output switches ON & timing function starts. If signal is opened and closed during the preset time, the timing restarts. After preset time 'T' has elapsed, the output switches OFF.

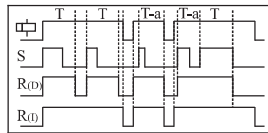

#### LEADING EDGE IMPULSE

When the supply applied and signal is closed, the output switches ON for preset time 'T'. After the completion of preset time 'T', the output switches OFF. If signal closed or opened during preset time duration 'T', the output remains unaffected.

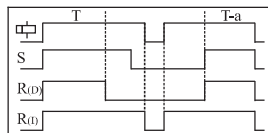

#### TRAILING EDGE IMPULSE

When supply voltage is applied and signal is opened, output switches ON for the preset time duration 'T'. After completion of preset time 'T', output switches OFF. If the signal is closed during preset timing 'T', output switches OFF & timing stops.

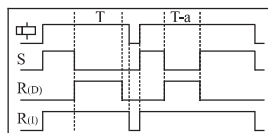

#### CYCLIC OFF/ON

When the supply applied and signal is closed, output switches OFF for the preset time duration 'T' and then switches ON for preset time duration 'T'. This cycle repeats while the supply is present. Changing the state of signal during 'T' does not affect the output.

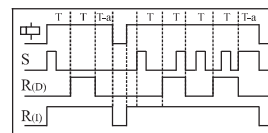

#### CYCLIC ON/OFF

When the supply applied and signal is closed, output switches ON for the preset time duration 'T' and then switches OFF for preset time duration 'T'. This cycle repeats while the supply is present. Changing the state of signal during 'T' does not affect the output.

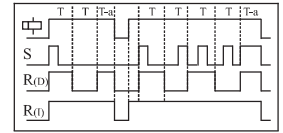

#### SIGNAL ON/ OFF Delay

Signal ON/OFF Delay: When the supply is applied and signal is closed, outputs switches ON after preset time 'T'. During the timing 'T' if signal is opened, the output switches ON immediately and OFF delay starts. Once this time period has elapsed the output switches OFF. During this OFF delay if signal is closed, the output switches OFF immediately and ON Delay restarts.

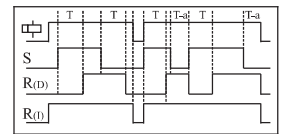

#### IMPULSE ON/OFF

When supply is applied and if signal closed or opened, output switches ON for Preset time duration 'T'. During time period 'T', changing state of input signal does not affect the output but resets the timing.

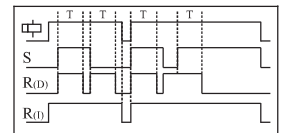

#### ACCUMULATIVE DELAY ON SIGNAL

Accumulative Delay ON Signal: On application of the supply voltage, the preset timing commences. Whenever signal is closed, timing pauses & resumes back only when the input signal is opened. The output switches ON at the end of the preset time duration 'T'.

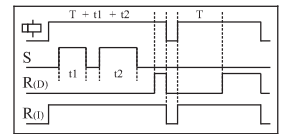

#### DELAYED IMPULSE

Delayed Impulse: When supply voltage is applied and signal is closed, output switches ON at the end of the preset time 'TOFF'. Then the preset ON time 'TON' starts irrespective of the signal state and remains ON till the completion of preset time duration 'TON'. If signal closed during the timing 'TOFF', the timing restarts but the output state remains unaffected. The signal change does not have any effect during the timing period 'TON'.

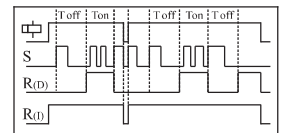

#### ONE SHOT

One Shot: When the supply voltage is applied and signal is closed, timing starts and after the preset time duration 'T', output switches ON for One sec. only.

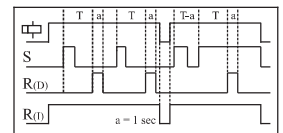

#### STEP MODE

Step Mode: When the supply voltage is applied and signal closed, output switches ON for preset time duration 'T', removal of the input signal during this time duration 'T' does not affect the output state. But if the signal is closed during time duration 'T', output switches OFF.

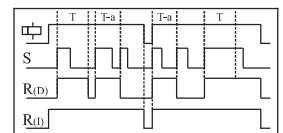

#### SIGNAL OFF DELAY

Signal OFF Delay: When the supply is applied and signal is closed, output switches ON. When signal is opened, the preset timing commences and output is switches OFF at the end of time duration 'T'. If signal is closed during timing period, then timing stops and restarts when signal.

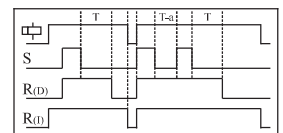



# Electronic Timer - Series Micon® 225

## Signal Based Multi - Function

Selection of Function: Operating Mode & timing can be selected by using DIP switches

Function		Function	
1	2 3 4	1	2 3 4
<input checked="" type="checkbox"/>	<input checked="" type="checkbox"/>	<input checked="" type="checkbox"/>	<input checked="" type="checkbox"/>
On Delay (Non Signal)		Signal OFF Delay	
<input checked="" type="checkbox"/>	<input checked="" type="checkbox"/>	<input checked="" type="checkbox"/>	<input checked="" type="checkbox"/>
Signal On Delay Type 1		Step Mode	
<input checked="" type="checkbox"/>	<input checked="" type="checkbox"/>	<input checked="" type="checkbox"/>	<input checked="" type="checkbox"/>
Signal On Delay		One Shot	
<input checked="" type="checkbox"/>	<input checked="" type="checkbox"/>	<input checked="" type="checkbox"/>	<input checked="" type="checkbox"/>
Inverted Signal On Delay		Delayed Impulse	
<input checked="" type="checkbox"/>	<input checked="" type="checkbox"/>	<input checked="" type="checkbox"/>	<input checked="" type="checkbox"/>
Interval		Accumulative Delay On Signal	
<input checked="" type="checkbox"/>	<input checked="" type="checkbox"/>	<input checked="" type="checkbox"/>	<input checked="" type="checkbox"/>
Leading Edge Impulse		Impulse ON / OFF	
<input checked="" type="checkbox"/>	<input checked="" type="checkbox"/>	<input checked="" type="checkbox"/>	<input checked="" type="checkbox"/>
Trailing Edge Impulse		Signal ON / OFF Delay	
<input checked="" type="checkbox"/>	<input checked="" type="checkbox"/>	<input checked="" type="checkbox"/>	<input checked="" type="checkbox"/>
Cyclic OFF / ON		Cyclic ON / OFF	
11 + 1D or 2D Selection		Timing Multiplier Selection	
5		6	
<input type="checkbox"/>	11 + 1D Operation	<input checked="" type="checkbox"/>	Timing = 'T' X 't' X 1
<input checked="" type="checkbox"/>	2 Delayed Operation	<input checked="" type="checkbox"/>	Timing = 'T' X 't' X 12

### MOUNTING DIMENSION (mm)

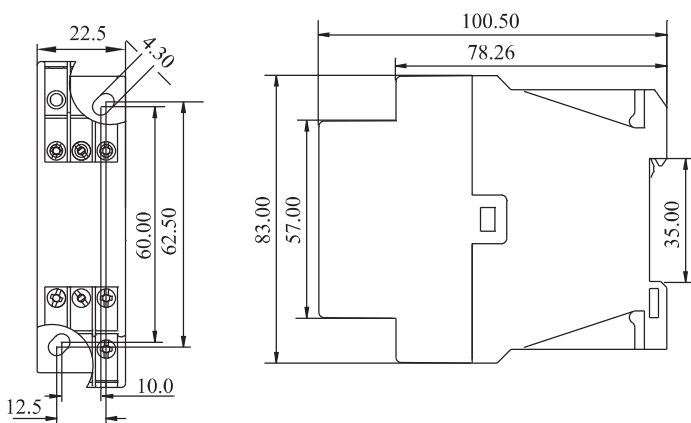

### CONNECTION DIAGRAM

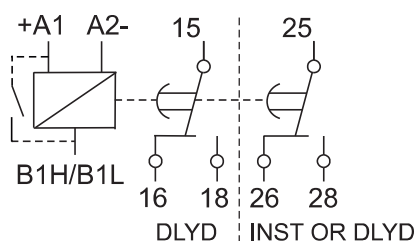

### TERMINAL TORQUE & TERMINAL CAPACITY

	0.60 N.m (6 Lb.in)
Ø 3.5 mm...4.0mm	1 x 4.0 mm <sup>2</sup> Solid/Stranded Wire
AWG	1 x 20 to 10