

Mini PLC PL - 100

- Supports up to 112 IOs
- Relay Base & MOSFET Low Side Base modules
- Stacking using FRC cable up to maximum 6 Expansion Modules
- Isolated Digital Inputs with sourcing & sinking capability
- Isolated Digital Transistorized Outputs (Low Side and High side driver)
- High Speed Inputs - Single / Quadrature (1x/2x/4x)
- High Speed Outputs (PTO / PWM / S-Profile)
- Analog Voltage/Current Inputs and Outputs of 0-10 V / 4-20 mA
- PC Software for programming, online & offline simulation
- Standard RS232/RS485 port with RJ11 for HMI/SCADA Interface
- Modbus RTU support
- 128 Weekly, Monthly & Yearly Time Switches each
- Multiple Timers, Counters including retentive counters, Hour meters & many more function blocks



Ordering Information

Cat. No.	Description
Base Models:	
PC10BD16001D1	DC Base with 8 Digital I/Ps, 8 Relay Outputs
PC10BD14002D1	DC Base with 8 Digital I/Ps (6 normal I/Ps + 2 high speed I/Ps), 6 Transistor Low Side Outputs (4 Normal O/Ps + 2 high speed O/Ps)
Extension Models:	
PC10ED08001N	Extension with 8 Digital Inputs
PC10ED08002N	Extension with 8 Relay Outputs
PC10ED16003N	Extension with 8 Digital Inputs and 8 Relay Outputs
PC10ED08004N	Extension with 8 Transistor Low Side Outputs
PC10ED08005N	Extension with 8 Transistor High Side Outputs
PC10EA04001N	Extension with 4 Analog Inputs (Max. 24, 0-10V / 4-20mA)
PC10EA02002N	Extension with 2 Analog Outputs (Max. 12, 0-10V / 4-20mA)
Application Software:	
PC10SN000N	PL-Soft
Accessories:	
28D33B0	Accessory, USB 2.0 Cable, Type A Male to B Male
PC10AC2	RS232 Communication Cable, PL-100 to HMI / SCADA
PC10AC3	RS485 Communication Cable, PL-100 to HMI / SCADA (DB9 Female to RJ-11)
PC10AC4	RS485 Communication Cable, PL-100 to HMI / SCADA (DB9 Male to RJ-11)

Mini PLC PL - 100



Cat. No.	PC10BD16001D1	PC10BD14002D1
Parameters		
Power Supply		
Supply Voltage (Φ)	24 VDC	
Supply Tolerance	- 20% to +10%	
Internal Current Consumption	65mA @ 24 VDC	60mA @ 24 VDC
Inrush Current	2.5A @ 24VDC	
Battery Backup (In Event of Power failure)	30 Days	
Separate Power Supply For Output	Not required	19.2 To 26.4 VDC (External fuse of 10A is recommended)
Digital Inputs		
No. of Inputs	8	6+2 High Speed
Grouping	(4+1 Common)*2	
Type of Inputs	Sinking / Sourcing	
Input Voltage Range	0 - 26.4 VDC	
Level (Logic 0)	Max. 7VDC	
Level (Logic 1)	Min. 16VDC	
Max. Input Current	1.2 mA per input	
Hardware Delay	5 msec	
Digital Filter Time (Sampling Time)	28 msec	
Min. Pulse Width	(Hardware Delay + Digital Filter Time) OR (System Loop Time) whichever is higher.	
Max. I/P frequency	10 Hz (for worst case condition)	
High Speed Level (Logic 0)	-	Max 1 VDC
High Speed Level (Logic 1)	-	Min 3 VDC
Max Input Current	-	1.2 mA per Input
Max High Speed Input Current	-	3 mA per Input
Min. Pulse width for High Speed Inputs (for 'low to high' or 'high to low' transition)	-	50 µSec (Min.)
Max. I/P frequency for high speed inputs.	-	Single Phase Mode - 10 kHz. Quadrature Mode 1X - 10 KHz, 2X - 5 KHz, 4X - 2.5 KHz
Digital Outputs		
No. of Outputs	8	4+2 High Speed
Grouping	(4+1 Common)*2	NA
Output Hardware	Relay (NO)	MOSFET Low Side Driver
Rated Load	5 A (Res.) @ 230 VAC / 30 VDC	24 VDC, 500 mA
Max load per common	10 A	
Max operations	1x10 ⁵	
Protection	External Fuse	Internally Protected (Max 3 A Per output)
Min. load for High Speed Output	-	10% of Rated Load (24 VDC, 500 mA)
HSD frequency	-	25 kHz max. for High Speed Outputs
Isolation		
Between Output & Supply	2KV	
Between Input & Supply	2KV	
Communication		
PC Port (USB)	USB Port (Type B) for PC Communication	
Isolation for USB Port	2KV between communication lines and internal circuit	
HMI Port (RS-232 / RS-485)	RJ11 Port for HMI (or any MODBUS Device)	
Communication parameters	Software selectable for HMI Port	
HMI port comm. Protocol	MODBUS Slave / MODBUS Master	
Functional		
Programming language	Ladder	
Scan Time	50 mS max.	
User Program memory	32 k	
User Data memory	1 k	
Maximum no. of I/O s	100	
Maximum no. of Extension modules	6	

Details continued on next page

Mini PLC PL - 100



Cat. No.	PC10BD16001D1	PC10BD14002D1
Indication		
Input	Yes (Green LED)	
Output	Yes (Red LED)	
RUN	Yes (Green LED)	
STOP	Yes (Red LED)	
ERROR	Yes (Red LED Blinking)	
Operating Temperature	0°C to 55°C	
Storage Temperature	-20°C to 70°C	
Relative Humidity	20-90% RH (Without condensation)	
Environmental Air	No excessive dust or corrosive gas allowed	
Dimension (W x H x D) (in mm)	72 x 90 x 58	
Weight (unpacked) Approx.	220g	
Mounting	DIN Rail (35 mm)	
Enclosure Material	UL 94 V0	
Degree of Protection	IP 20 for Terminals, IP 40 for Enclosure	
Certification		

EMI / EMC

ESD	IEC 61000-4-2
Radiated Susceptibility	IEC 61000-4-3
Electrical Fast Transients	IEC 61000-4-4
Surge	IEC 61000-4-5
Conducted Susceptibility	IEC 61000-4-6
Power Frequency Magnetic Field Test	IEC 61000-4-11
Conducted Emission	CISPR 14-1
Radiated Emission	CISPR 14-1

Safety Compliance

Test Voltage between I/P and O/P	IEC 60947-5-1
Impulse Voltage between I/P and O/P	IEC 60947-5-1
Single Fault	IEC 61010-1
Insulation Resistance	UL 508
Leakage Current	UL 508

Environmental Compliance

Cold Heat	IEC 60068-2-1
Dry Heat	IEC 60068-2-2
Vibration	IEC 60068-2-6
Repetitive Shock	IEC 60068-2-27
Non-repetitive Shock	IEC 60068-2-27

TERMINAL TORQUE & CAPACITY

 Ø 3.5	0.54 N.m (6 Lb.in)
	1 x 2.5 mm ² Solid Wire/Stranded
AWG	1 x 24 to 12

Mini PLC PL - 100



FUNCTION BLOCKS:

Sr. No.	Contact Blocks	Max. Available*
1	Positive Edge Contact	128
2	Negative Edge Contact	128
3	Not Contact	128
4	First Scan Contact	1
5	Auxiliary Relay State change	512
6	Auxiliary Relay Level change	512
7	Auxiliary Relay Bistable Set Reset	512

Sr. No.	Special I/O	Max. Available*
1	Timed I/O	1
2	Interrupt I/O	1

Sr. No.	Arithmetic Functions	Max. Available*
1	Arithmetic ADD	128
2	Arithmetic SUB	128
3	Arithmetic MUL	128
4	Arithmetic DIV	128
5	Arithmetic INC	128
6	Arithmetic DEC	128
7	Arithmetic MOD	128

Sr. No.	High Speed Output	Max. Available*
1	High Speed Output (PTO01)	1
2	High Speed Output (PTO02)	1
3	High Speed Output (PWM01)	1
4	High Speed Output (PWM02)	1
5	High Speed Output (SPO01)	1

Sr. No.	Move & Convert Functions	Max. Available*
1	Move	128
2	Block Move	8
3	Block Set	8
4	Compare	128
5	Convert	128
6	Scale Converter	16
7	Shift Left (SHL)	128
8	Shift Right (SHR)	128

Sr. No.	Timer & Time Switch Blocks	Max. Available*
1	ON Delay Timer	128
2	OFF Delay Timer	128
3	Cyclic ON/Off	128
4	Cyclic OFF/ON	128
5	Accumulative Delay ON Signal Timer	128
6	Accumulative Impulse ON Signal Timer	128
7	Impulse ON/OFF Timer	128
8	Signal OFF/ON Timer	128
9	Leading Edge Impulse 1 Timer	128
10	Leading Edge Impulse 2 Timer	128
11	Trailing Edge Impulse 1 Timer	128
12	Trailing Edge Impulse 2 Timer	128
13	Delayed Impulse Timer	128
14	Retentive ON Delay Timer	128
15	Retentive OFF Delay Timer	128
16	Time switch Weekly	128
17	Time switch Monthly	128
18	Time switch Yearly	128

Sr. No.	Logical Functions	Max. Available*
1	NOT	128
2	AND	128
3	OR	128
4	EXOR	128

Sr. No.	Hour & Counter blocks	Max. Available*
1	Up counter	128
2	Down counter	128
3	Up-Down counter	128
4	Retentive Up counter	128
5	Retentive Down counter	128
6	Retentive Up-Down counter	128
7	Hour meter	128
8	High Speed Counter 1	1
9	High Speed Counter 2	1

Sr. No.	MODBUS Functions	Max. Available*
1	MODBUS UNIT (Slave / Master)	1
2	MODBUS MASTER	16
3	Variable	1024**

*Maximum number of blocks that can be used in ladder depends on the user program memory.

**No of variables can be varied according to defined variable types.

i. Byte / SByte Type Variables - 1024. ii. Word / Sword Type Variables - 512. iii. Dword / SDword Type Variables - 256.

iv. Maximum size of Byte / Sbyte Type Array - 999

Mini PLC PL - 100



CONNECTION DIAGRAM

Connecting Power Supply to PL-100 Units

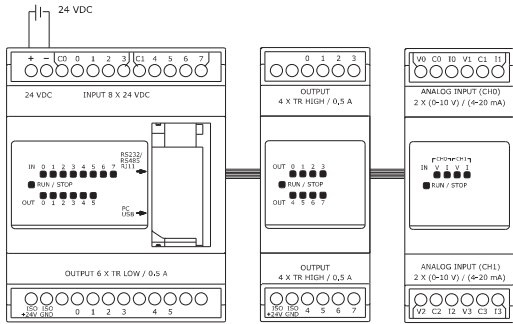

Connecting Positive Common

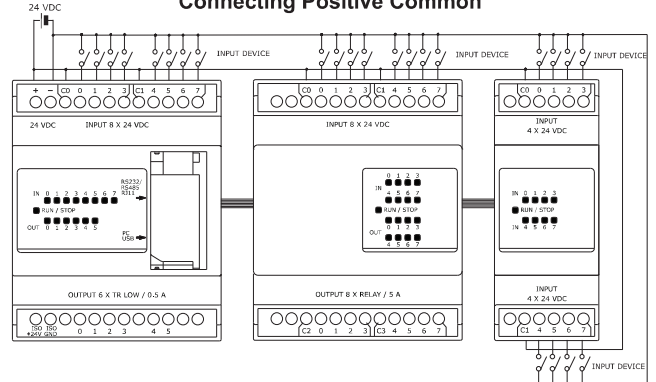

Connecting Negative Common

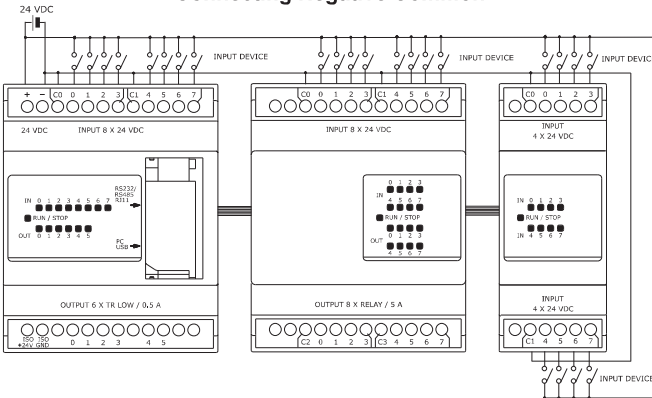

Connecting DC Relay Output

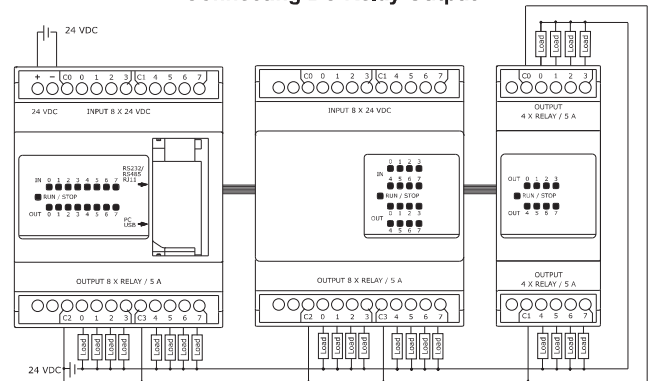

Connecting AC Relay Output

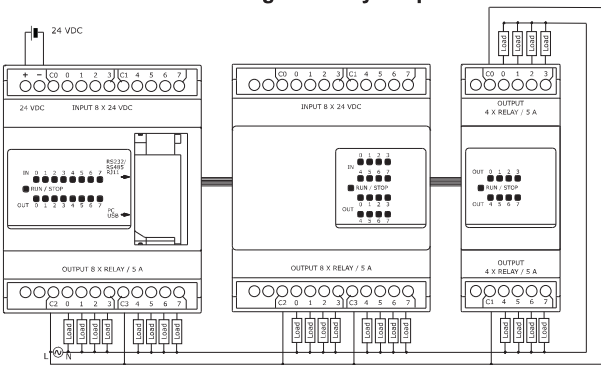

Connecting Low Side Output

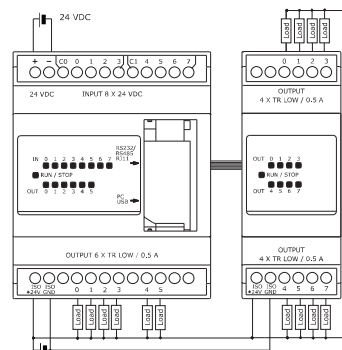

Connecting High Side Output

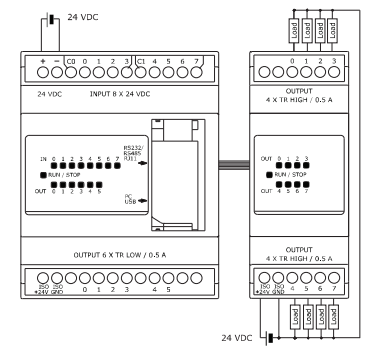

Connecting Analog Input Model

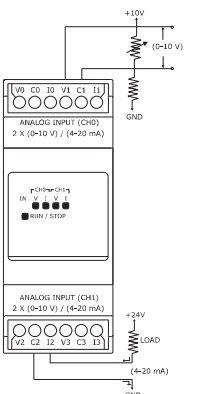

Connecting Analog Output Model

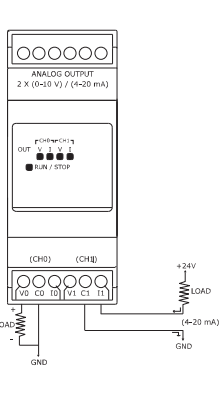

MOUNTING DIMENSIONS (mm)

