

Technical data sheet

MultiBase base

Item no. 5096680



- Suitable for V25-B+C, V20-C and V10-C
- Pre-mounted and ready for connection
- For TN systems
- Multifunction terminals for easy circuit of series-mounted devices
- Upper parts can be rotated through 180 degrees



Dimensions

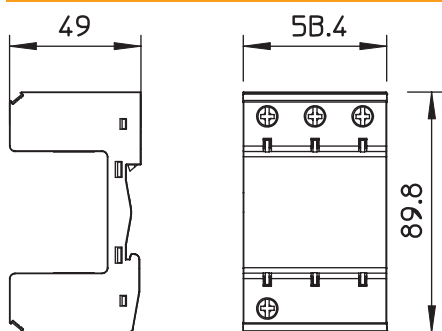

Master data

Item no.	5096680
Type	MB 4
Description 1	MultiBase
Description 2	4-pole
Dimension	4-polig
Smallest sales unit (VG)	1,00 Piece
Weight	21,00 kg/100 pc.

Technical data sheet

MultiBase base

Item no. 5096680



Technical data

Temperature range	-40+80 °C
Pole version	4
Version	4-pole
Version	4-pole
Mounting type	Hat rail 35 mm
Installation type	DIN rail 35 mm
Protection rating	IP20
Protection rating	IP 20
Division unit TE (17.5 mm)	4
Connection cross-section, flexible	2,50 - 25,00 mm ²
Connection cross-section, rigid	2,50 - 35,00 mm ²
Connection cross-section, multi-wire	2,50 - 35,00 mm ²
Signalling on device	None