

# Cylindrical Proximity Sensor E2B

*Reliable performance for standard industrial environments.*

- Four sizes: M8, M12, M18 and M30
- Single and double sensing distance
- Normally open (NO), Normally closed (NC)
- IP67 for protection in wet environments
- 360° visible LED for operation control
- Standard temperature range -25°C to 70°C
- A choice of Short or Long bodies in Connector or Pre-wired designs



## Ordering Information

Double sensing distance, DC 3-wire models

Size		Sensing distance	Connection	Body material	Body length	Output	Operation mode NO	Operation mode NC
M8	Shielded	2 mm	Pre-wired	Stainless steel	Short	PNP	E2B-S08KS02-WP-B1 2M	E2B-S08KS02-WP-B2 2M
						NPN	E2B-S08KS02-WP-C1 2M	E2B-S08KS02-WP-C2 2M
					Long	PNP	E2B-S08LS02-WP-B1 2M	E2B-S08LS02-WP-B2 2M
						NPN	E2B-S08LS02-WP-C1 2M	E2B-S08LS02-WP-C2 2M
			M8 connector (3-pin)		Short	PNP	E2B-S08KS02-MC-B1	E2B-S08KS02-MC-B2
						NPN	E2B-S08KS02-MC-C1	E2B-S08KS02-MC-C2
					Long	PNP	E2B-S08LS02-MC-B1	E2B-S08LS02-MC-B2
						NPN	E2B-S08LS02-MC-C1	E2B-S08LS02-MC-C2
	Non-Shielded	4 mm	Pre-wired		Short	PNP	E2B-S08KN04-WP-B1 2M	E2B-S08KN04-WP-B2 2M
						NPN	E2B-S08KN04-WP-C1 2M	E2B-S08KN04-WP-C2 2M
					Long	PNP	E2B-S08LN04-WP-B1 2M	E2B-S08LN04-WP-B2 2M
						NPN	E2B-S08LN04-WP-C1 2M	E2B-S08LN04-WP-C2 2M
			M8 connector (3-pin)		Short	PNP	E2B-S08KN04-MC-B1	E2B-S08KN04-MC-B2
						NPN	E2B-S08KN04-MC-C1	E2B-S08KN04-MC-C2
					Long	PNP	E2B-S08LN04-MC-B1	E2B-S08LN04-MC-B2
						NPN	E2B-S08LN04-MC-C1	E2B-S08LN04-MC-C2
M12	Shielded	4 mm	Pre-wired	Brass	Short	PNP	E2B-M12KS04-WP-B1 2M	E2B-M12KS04-WP-B2 2M
						NPN	E2B-M12KS04-WP-C1 2M	E2B-M12KS04-WP-C2 2M
					Long	PNP	E2B-M12LS04-WP-B1 2M	E2B-M12LS04-WP-B2 2M
						NPN	E2B-M12LS04-WP-C1 2M	E2B-M12LS04-WP-C2 2M
			M12 connector (4-pin)		Short	PNP	E2B-M12KS04-M1-B1	E2B-M12KS04-M1-B2
						NPN	E2B-M12KS04-M1-C1	E2B-M12KS04-M1-C2
					Long	PNP	E2B-M12LS04-M1-B1	E2B-M12LS04-M1-B2
						NPN	E2B-M12LS04-M1-C1	E2B-M12LS04-M1-C2
	Non-Shielded	8 mm	Pre-wired		Short	PNP	E2B-M12KN08-WP-B1 2M	E2B-M12KN08-WP-B2 2M
						NPN	E2B-M12KN08-WP-C1 2M	E2B-M12KN08-WP-C2 2M
					Long	PNP	E2B-M12LN08-WP-B1 2M	E2B-M12LN08-WP-B2 2M
						NPN	E2B-M12LN08-WP-C1 2M	E2B-M12LN08-WP-C2 2M
			M12 connector (4-pin)		Short	PNP	E2B-M12KN08-M1-B1	E2B-M12KN08-M1-B2
						NPN	E2B-M12KN08-M1-C1	E2B-M12KN08-M1-C2
					Long	PNP	E2B-M12LN08-M1-B1	E2B-M12LN08-M1-B2
						NPN	E2B-M12LN08-M1-C1	E2B-M12LN08-M1-C2

Size		Sensing distance	Connection	Body material	Body length	Output	Operation mode NO	Operation mode NC
M18	Shielded	8 mm	Pre-wired	Brass	Short	PNP	E2B-M18KS08-WP-B1 2M	E2B-M18KS08-WP-B2 2M
						NPN	E2B-M18KS08-WP-C1 2M	E2B-M18KS08-WP-C2 2M
					Long	PNP	E2B-M18LS08-WP-B1 2M	E2B-M18LS08-WP-B2 2M
			NPN			E2B-M18LS08-WP-C1 2M	E2B-M18LS08-WP-C2 2M	
			M12 connector (4-pin)		Short	PNP	E2B-M18KS08-M1-B1	E2B-M18KS08-M1-B2
						NPN	E2B-M18KS08-M1-C1	E2B-M18KS08-M1-C2
	Long	PNP			E2B-M18LS08-M1-B1	E2B-M18LS08-M1-B2		
		NPN	E2B-M18LS08-M1-C1		E2B-M18LS08-M1-C2			
	Non-Shielded	16 mm	Pre-wired		Short	PNP	E2B-M18KN16-WP-B1 2M	E2B-M18KN16-WP-B2 2M
						NPN	E2B-M18KN16-WP-C1 2M	E2B-M18KN16-WP-C2 2M
					Long	PNP	E2B-M18LN16-WP-B1 2M	E2B-M18LN16-WP-B2 2M
			NPN			E2B-M18LN16-WP-C1 2M	E2B-M18LN16-WP-C2 2M	
M12 connector (4-pin)			Short	PNP	E2B-M18KN16-M1-B1	E2B-M18KN16-M1-B2		
				NPN	E2B-M18KN16-M1-C1	E2B-M18KN16-M1-C2		
	Long	PNP	E2B-M18LN16-M1-B1	E2B-M18LN16-M1-B2				
NPN		E2B-M18LN16-M1-C1	E2B-M18LN16-M1-C2					
M30	Shielded	15 mm	Pre-wired	Brass	Short	PNP	E2B-M30KS15-WP-B1 2M	E2B-M30KS15-WP-B2 2M
						NPN	E2B-M30KS15-WP-C1 2M	E2B-M30KS15-WP-C2 2M
					Long	PNP	E2B-M30LS15-WP-B1 2M	E2B-M30LS15-WP-B2 2M
			NPN			E2B-M30LS15-WP-C1 2M	E2B-M30LS15-WP-C2 2M	
			M12 connector (4-pin)		Short	PNP	E2B-M30KS15-M1-B1	E2B-M30KS15-M1-B2
						NPN	E2B-M30KS15-M1-C1	E2B-M30KS15-M1-C2
	Long	PNP			E2B-M30LS15-M1-B1	E2B-M30LS15-M1-B2		
		NPN	E2B-M30LS15-M1-C1		E2B-M30LS15-M1-C2			
	Non-Shielded	30 mm	Pre-wired		Long	PNP	E2B-M30LN30-WP-B1 2M	E2B-M30LN30-WP-B2 2M
						NPN	E2B-M30LN30-WP-C1 2M	E2B-M30LN30-WP-C2 2M
					M12 connector (4-pin)	Long	PNP	E2B-M30LN30-M1-B1
			NPN				E2B-M30LN30-M1-C1	E2B-M30LN30-M1-C2

\*1. Material specifications for stainless steel housing case: 1.4305 (W.-No.), SUS 303 (AISI), 2346 (SS).

Single sensing distance, DC 3-wire models





Size		Sensing distance	Connection	Body material	Body length	Output	Operation mode NO	Operation mode NC
M8	Shielded	1 mm	Pre-wired	Stainless steel	Short	PNP	E2B-S08KS01-WP-B1 2M	E2B-S08KS01-WP-B2 2M
						NPN	E2B-S08KS01-WP-C1 2M	E2B-S08KS01-WP-C2 2M
					Long	PNP	E2B-S08LS01-WP-B1 2M	E2B-S08LS01-WP-B2 2M
			NPN			E2B-S08LS01-WP-C1 2M	E2B-S08LS01-WP-C2 2M	
			M8 connector (3-pin)		Short	PNP	E2B-S08KS01-MC-B1	E2B-S08KS01-MC-B2
						NPN	E2B-S08KS01-MC-C1	E2B-S08KS01-MC-C2
	Long	PNP			E2B-S08LS01-MC-B1	E2B-S08LS01-MC-B2		
		NPN	E2B-S08LS01-MC-C1		E2B-S08LS01-MC-C2			
	Non-Shielded	2 mm	Pre-wired		Short	PNP	E2B-S08KN02-WP-B1 2M	E2B-S08KN02-WP-B2 2M
						NPN	E2B-S08KN02-WP-C1 2M	E2B-S08KN02-WP-C2 2M
					Long	PNP	E2B-S08LN02-WP-B1 2M	E2B-S08LN02-WP-B2 2M
			NPN			E2B-S08LN02-WP-C1 2M	E2B-S08LN02-WP-C2 2M	
M8 connector (3-pin)			Short	PNP	E2B-S08KN02-MC-B1	E2B-S08KN02-MC-B2		
				NPN	E2B-S08KN02-MC-C1	E2B-S08KN02-MC-C2		
	Long	PNP	E2B-S08LN02-MC-B1	E2B-S08LN02-MC-B2				
NPN		E2B-S08LN02-MC-C1	E2B-S08LN02-MC-C2					
M12	Shielded	2 mm	Pre-wired	Brass	Short	PNP	E2B-M12KS02-WP-B1 2M	E2B-M12KS02-WP-B2 2M
						NPN	E2B-M12KS02-WP-C1 2M	E2B-M12KS02-WP-C2 2M
					Long	PNP	E2B-M12LS02-WP-B1 2M	E2B-M12LS02-WP-B2 2M
			NPN			E2B-M12LS02-WP-C1 2M	E2B-M12LS02-WP-C2 2M	
			M12 connector (4-pin)		Short	PNP	E2B-M12KS02-M1-B1	E2B-M12KS02-M1-B2
						NPN	E2B-M12KS02-M1-C1	E2B-M12KS02-M1-C2
	Long	PNP			E2B-M12LS02-M1-B1	E2B-M12LS02-M1-B2		
		NPN	E2B-M12LS02-M1-C1		E2B-M12LS02-M1-C2			
	Non-Shielded	5 mm	Pre-wired		Short	PNP	E2B-M12KN05-WP-B1 2M	E2B-M12KN05-WP-B2 2M
						NPN	E2B-M12KN05-WP-C1 2M	E2B-M12KN05-WP-C2 2M
					Long	PNP	E2B-M12LN05-WP-B1 2M	E2B-M12LN05-WP-B2 2M
			NPN			E2B-M12LN05-WP-C1 2M	E2B-M12LN05-WP-C2 2M	
M12 connector (4-pin)			Short	PNP	E2B-M12KN05-M1-B1	E2B-M12KN05-M1-B2		
				NPN	E2B-M12KN05-M1-C1	E2B-M12KN05-M1-C2		
	Long	PNP	E2B-M12LN05-M1-B1	E2B-M12LN05-M1-B2				
NPN		E2B-M12LN05-M1-C1	E2B-M12LN05-M1-C2					

Single sensing distance, DC 3-wire models

Size	Sensing distance	Connection	Body material	Body length	Output	Operation mode NO	Operation mode NC
M18	Shielded	Pre-wired	Brass	Short	PNP	E2B-M18KS05-WP-B1 2M	E2B-M18KS05-WP-B2 2M
					NPN	E2B-M18KS05-WP-C1 2M	E2B-M18KS05-WP-C2 2M
				Long	PNP	E2B-M18LS05-WP-B1 2M	E2B-M18LS05-WP-B2 2M
		NPN			E2B-M18LS05-WP-C1 2M	E2B-M18LS05-WP-C2 2M	
		M12 connector (4-pin)		Short	PNP	E2B-M18KS05-M1-B1	E2B-M18KS05-M1-B2
					NPN	E2B-M18KS05-M1-C1	E2B-M18KS05-M1-C2
	Long			PNP	E2B-M18LS05-M1-B1	E2B-M18LS05-M1-B2	
		NPN		E2B-M18LS05-M1-C1	E2B-M18LS05-M1-C2		
	Non-Shielded	Pre-wired		Short	PNP	E2B-M18KN10-WP-B1 2M	E2B-M18KN10-WP-B2 2M
					NPN	E2B-M18KN10-WP-C1 2M	E2B-M18KN10-WP-C2 2M
				Long	PNP	E2B-M18LN10-WP-B1 2M	E2B-M18LN10-WP-B2 2M
		NPN			E2B-M18LN10-WP-C1 2M	E2B-M18LN10-WP-C2 2M	
		M12 connector (4-pin)	Short	PNP	E2B-M18KN10-M1-B1	E2B-M18KN10-M1-B2	
				NPN	E2B-M18KN10-M1-C1	E2B-M18KN10-M1-C2	
	Long		PNP	E2B-M18LN10-M1-B1	E2B-M18LN10-M1-B2		
		NPN	E2B-M18LN10-M1-C1	E2B-M18LN10-M1-C2			
M30	Shielded	Pre-wired	Brass	Short	PNP	E2B-M30KS10-WP-B1 2M	E2B-M30KS10-WP-B2 2M
					NPN	E2B-M30KS10-WP-C1 2M	E2B-M30KS10-WP-C2 2M
				Long	PNP	E2B-M30LS10-WP-B1 2M	E2B-M30LS10-WP-B2 2M
		NPN			E2B-M30LS10-WP-C1 2M	E2B-M30LS10-WP-C2 2M	
		M12 connector (4-pin)		Short	PNP	E2B-M30KS10-M1-B1	E2B-M30KS10-M1-B2
					NPN	E2B-M30KS10-M1-C1	E2B-M30KS10-M1-C2
	Long			PNP	E2B-M30LS10-M1-B1	E2B-M30LS10-M1-B2	
		NPN		E2B-M30LS10-M1-C1	E2B-M30LS10-M1-C2		
	Non-Shielded	Pre-wired		Short	PNP	E2B-M30KN20-WP-B1 2M	E2B-M30KN20-WP-B2 2M
					NPN	E2B-M30KN20-WP-C1 2M	E2B-M30KN20-WP-C2 2M
				Long	PNP	E2B-M30LN20-WP-B1 2M	E2B-M30LN20-WP-B2 2M
		NPN			E2B-M30LN20-WP-C1 2M	E2B-M30LN20-WP-C2 2M	
		M12 connector (4-pin)	Short	PNP	E2B-M30KN20-M1-B1	E2B-M30KN20-M1-B2	
				NPN	E2B-M30KN20-M1-C1	E2B-M30KN20-M1-C2	
	Long		PNP	E2B-M30LN20-M1-B1	E2B-M30LN20-M1-B2		
		NPN	E2B-M30LN20-M1-C1	E2B-M30LN20-M1-C2			

Accessories (Order separately)

Connector cables

Size	Appearance	Cable Type	Model
M8	Straight 	2 m	XS3F-M8PVC3S2M
		5 m	XS3F-M8PVC3S5M
	Angle 	2 m	XS3F-M8PVC3A2M
		5 m	XS3F-M8PVC3A5M
M12	Straight 	2 m	XS2F-M12PVC4S2M
		5 m	XS2F-M12PVC4S5M
	Angle 	2 m	XS2F-M12PVC4A2M
		5 m	XS2F-M12PVC4A5M

## Connectivity

E2B sensors are available with the following connectors and cable materials:

### Pre-wired models



Standard cable lengths are 2 m and 5 m.  
Standard cable material: PVC (dia 4 mm)-WP

### Connector models



Standard connectors: M12, M8

## Model number legend

**E2B**-□□□□□□-□-□□□□

1 2 3 4 5 6 7 8 9 10

**Example:** E2B-M12LS04-M1-B1

E2B-S08KN04-WP-B1 5M

Standard, M12, long barrel, shielded, Sn=4 mm, M12 connector, PNP-NO

Standard, M8 stainless steel, short barrel, non-shielded, Sn=4 mm, pre-wired PVC cable, PNP-NO, cable length=5 m

### 1. Basic name

E2B

### 2. Housing shape and material

M: Cylindrical, metric threaded, brass

S: Cylindrical, metric threaded, stainless steel

### 3. Housing size

08: 8 mm

12: 12 mm

18: 18 mm

30: 30 mm

### 4. Barrel length

K: Standard length

L: Long body

### 5. Shield

S: Shielded

N: Non-shielded

### 6. Sensing distance

Numeral: Sensing distance: e.g. 02=2 mm, 16=16 mm

### 7. Type of connection

WP: pre-wired, PVC, dia 4mm (standard)

M1: M12 connector (4 pin)

MC: M8 connector (3 pin)

### 8. Power source and output

B: DC, 3-wire, PNP open collector

C: DC, 3-wire, NPN open collector

### 9. Operation mode

1: Normally open (NO)

2: Normally closed (NC)

### 10. Cable length

Blank: Connector type

Numeral: Cable length

Specifications

Double sensing distance, DC 3-wire models

Item	Size Type	M8		M12	
		Shielded	Non-shielded	Shielded	Non-shielded
		E2B-S08KS02-__-B1 E2B-S08KS02-__-C1	E2B-S08KN04-__-B1 E2B-S08KN04-__-C1	E2B-M12KS04-__-B1 E2B-M12KS04-__-C1	E2B-M12KN08-__-B1 E2B-M12KN08-__-C1
Sensing distance		2 mm	4 mm	4 mm	8 mm
Differential travel		10% max. of sensing distance			
Target		Ferrous metal (The sensing distance decreases with non-ferrous metal.)			
Standard target (mild steel ST37)		8 × 8 × 1 mm	12 × 12 × 1 mm	12 × 12 × 1 mm	24 × 24 × 1 mm
Response frequency (See note 1.)		1,500 Hz	1,000 Hz	1,000 Hz	800 Hz
Power supply voltage (operating voltage range)		12 to 24 VDC. Ripple (p-p): 10% max. (10 to 32 VDC)			
Current consumption (DC 3-wire)		10 mA max.			
Output type		B models: PNP open collector, C models: NPN open collector			
Control output Load current		200 mA max. (30 VDC max.)			
Indicator		Round visible LED indicator for cable type sensors.			
Operation mode		B1/-C1 models: NO; B2/-C2 models: NC			
Protection circuit		Output reverse polarity protection, Power source circuit reverse polarity protection,			
Ambient air temperature		Operating & Storage: -25 to 70°C (with no icing or condensation)			
Temperature influence		±10% max. of sensing distance at 23°C within temperature range of -25 to 70°C			
Ambient humidity		Operating and Storage: 35% to 95%			
Voltage influence		±1% max. of sensing distance in rated voltage range ±15%			
Insulation resistance		50 MΩ min. (at 500 VDC) between current carry parts and case			
Dielectric strength		1,000 VAC at 50/60 Hz for 1 min between current carry parts and case			
Vibration resistance		10 to 55 Hz, 1.5-mm double amplitude for 2 hours each in X, Y and Z directions			
Shock resistance		M8: 500 m/s <sup>2</sup> , 10 times each in X, Y and Z directions M12-M30: 1,000 m/s <sup>2</sup> , 10 times each in X, Y and Z directions			
Standards and listing		IP67 after IEC 60529 EMC after EN60947-5-2			
Connection method		(1) Pre-wired models (standard is dia 4.0 mm PVC with length = 2 m, 5 m) (2) Connector models (Head M8: M8-3pin, Head M12-M30: M12-4Pin)			
Material	Case	Stainless steel		Brass-nickel plated	
	Sensing surface	PBT			
	Cable	Standard cable is PVC dia 4 mm.			
Weight (packaged)	Pre-wired models	Approx. 85 g			
	Connector models	Approx. 35 g			

**Note 1.** The response frequency is an average value. Measurement conditions are as follows: standard target, twice the standard target distance between targets, and a setting distance of half the sensing distance.

Double sensing distance, DC 3-wire models

Item	Size Type	M18		M30	
		Shielded	Non-shielded	Shielded	Non-shielded
		E2B-M18KS08-__-B1 E2B-M18KS08-__-C1	E2B-M18KN16-__-B1 E2B-M18KN16-__-C1	E2B-M30KS15-__-B1 E2B-M30KS15-__-C1	E2B-M30LN30-__-B1 E2B-M30LN30-__-C1
Sensing distance		8 mm	16 mm	15 mm	30 mm
Differential travel		10% max. of sensing distance			
Target		Ferrous metal (The sensing distance decreases with non-ferrous metal.)			
Standard target (mild steel ST37)		24 × 24 × 1 mm	48 × 48 × 1 mm	45 × 45 × 1 mm	90 × 90 × 1 mm
Response frequency (See note 1.)		500 Hz	400 Hz	250 Hz	100 Hz
Power supply voltage (operating voltage range)		12 to 24 VDC. Ripple (p-p): 10% max. (10 to 32 VDC)			
Current consumption (DC 3-wire)		10 mA max.			
Output type		B models: PNP open collector, C models: NPN open collector			
Control output Load current		200 mA max. (30 VDC max.)			
Indicator		Round visible LED indicator for cable type sensors.			
Operation mode		B1/-C1 models: NO; B2/-C2 models: NC			
Protection circuit		Output reverse polarity protection, Power source circuit reverse polarity protection,			
Ambient air temperature		Operating & Storage: -25 to 70°C (with no icing or condensation)			
Temperature influence		±10% max. of sensing distance at 23°C within temperature range of -25 to 70°C			
Ambient humidity		Operating and Storage: 35% to 95%			
Voltage influence		±1% max. of sensing distance in rated voltage range ±15%			
Insulation resistance		50 MΩ min. (at 500 VDC) between current carry parts and case			
Dielectric strength		1,000 VAC at 50/60 Hz for 1 min between current carry parts and case			
Vibration resistance		10 to 55 Hz, 1.5-mm double amplitude for 2 hours each in X, Y and Z directions			
Shock resistance		M8: 500 m/s <sup>2</sup> , 10 times each in X, Y and Z directions M12-M30: 1000 m/s <sup>2</sup> , 10 times each in X, Y and Z directions			
Standards and listing		IP67 after IEC 60529 EMC after EN60947-5-2			
Connection method		(1) Pre-wired models (standard is dia 4.0 mm PVC with length = 2 m, 5 m) (2) Connector models (Head M8: M8-3pin, Head M12-M30: M12-4Pin)			
Material	Case	Brass-nickel plated			
	Sensing surface	PBT			
	Cable	Standard cable is PVC dia 4 mm.			
Weight (packaged)	Pre-wired models	Approx. 85 g			
	Connector models	Approx. 35 g			

**Note 1.** The response frequency is an average value. Measurement conditions are as follows: standard target, twice the standard target distance between targets, and a setting distance of half the sensing distance.

Single sensing distance, DC 3-wire models

Item	Size Type	M8		M12	
		Shielded	Non-shielded	Shielded	Non-shielded
		E2B-S08KS01-__-B1 E2B-S08KS01-__-C1	E2B-S08KN02-__-B1 E2B-S08KN02-__-C1	E2B-M12KS02-__-B1 E2B-M12KS02-__-C1	E2B-M12KN05-__-B1 E2B-M12KN05-__-C1
Sensing distance		1 mm	2 mm	2 mm	5 mm
Differential travel		10% max. of sensing distance			
Target		Ferrous metal (The sensing distance decreases with non-ferrous metal.)			
Standard target (mild steel ST37)		8 × 8 × 1 mm	12 × 12 × 1 mm	12 × 12 × 1 mm	24 × 24 × 1 mm
Response frequency (See note 1.)		1,500 Hz	1,000 Hz	1,000 Hz	800 Hz
Power supply voltage (operating voltage range)		12 to 24 VDC. Ripple (p-p): 10% max. (10 to 32 VDC)			
Current consumption (DC 3-wire)		10 mA max.			
Output type		B models: PNP open collector, C models: NPN open collector			
Control output Load current		200 mA max. (30 VDC max.)			
Indicator		Round visible LED indicator for cable type sensors.			
Operation mode		B1/-C1 models: NO; B2/-C2 models: NC			
Protection circuit		Output reverse polarity protection, Power source circuit reverse polarity protection			
Ambient air temperature		Operating & Storage: -25 to 70°C (with no icing or condensation)			
Temperature influence		±10% max. of sensing distance at 23°C			
Ambient humidity		Operating and Storage: 35% to 95%			
Voltage influence		±1% max. of sensing distance in rated voltage range ±15%			
Insulation resistance		50 MΩ min. (at 500 VDC) between current carry parts and case			
Dielectric strength		1,000 VAC at 50/60 Hz for 1 min between current carry parts and case			
Vibration resistance		10 to 55 Hz, 1.5-mm double amplitude for 2 hours each in X, Y and Z directions			
Shock resistance		M8: 500 m/s <sup>2</sup> , 10 times each in X, Y and Z directions M12-M30: 1000 m/s <sup>2</sup> , 10 times each in X, Y and Z directions			
Standards and listing		IP67 after IEC 60529 EMC after EN60947-5-2			
Connection method		(1) Pre-wired models (standard is dia 4.0 mm PVC with length = 2 m,5 m) (2) Connector models (Head M8: M8-3pin, Head M12-M30: M12-4Pin)			
Material	Case	Stainless steel		Brass-nickel plated	
	Sensing surface	PBT			
	Cable	Standard cable is PVC dia 4 mm.			
Weight (packaged)	Pre-wired models	Approx. 65 g			
	Connector models	Approx. 15 g			

**Note 1.** The response frequency is an average value. Measurement conditions are as follows: standard target, twice the standard target distance between targets, and a setting distance of half the sensing distance.

Single sensing distance, DC 3-wire models

Item	Size Type	M18		M30	
		Shielded	Non-shielded	Shielded	Non-shielded
		E2B-M18KS05-__-B1 E2B-M18KS05-__-C1	E2B-M18KN10-__-B1 E2B-M18KN10-__-C1	E2B-M30KS10-__-B1 E2B-M30KS10-__-C1	E2B-M30LN20-__-B1 E2B-M30LN20-__-C1
Sensing distance		5 mm	10 mm	10 mm	20 mm
Differential travel		10% max. of sensing distance			
Target		Ferrous metal (The sensing distance decreases with non-ferrous metal.)			
Standard target (mild steel ST37)		24 × 24 × 1 mm	48 × 48 × 1 mm	45 × 45 × 1 mm	90 × 90 × 1 mm
Response frequency (See note 1.)		500 Hz	400 Hz	250 Hz	100 Hz
Power supply voltage (operating voltage range)		12 to 24 VDC. Ripple (p-p): 10% max. (10 to 32 VDC)			
Current consumption (DC 3-wire)		10 mA max.			
Output type		B models: PNP open collector, C models: NPN open collector			
Control output Load current		200 mA max. (30 VDC max.)			
Indicator		Round visible LED indicator for cable type sensors.			
Operation mode		B1/-C1 models: NO; B2/-C2 models: NC			
Protection circuit		Output reverse polarity protection, Power source circuit reverse polarity protection,			
Ambient air temperature		Operating & Storage: -25 to 70°C (with no icing or condensation)			
Temperature influence		±10% max. of sensing distance at 23°C			
Ambient humidity		Operating and Storage: 35% to 95%			
Voltage influence		±1% max. of sensing distance in rated voltage range ±15%			
Insulation resistance		50 MΩ min. (at 500 VDC) between current carry parts and case			
Dielectric strength		1,000 VAC at 50/60 Hz for 1 min between current carry parts and case			
Vibration resistance		10 to 55 Hz, 1.5-mm double amplitude for 2 hours each in X, Y and Z directions			
Shock resistance		M8: 500 m/s <sup>2</sup> , 10 times each in X, Y and Z directions M12-M30: 1000 m/s <sup>2</sup> , 10 times each in X, Y and Z directions			
Standards and listing		IP67 after IEC 60529 EMC after EN60947-5-2			
Connection method		(1) Pre-wired models (standard is dia 4.0 mm PVC with length = 2 m,5 m) (2) Connector models (Head M8: M8-3pin, Head M12-M30: M12-4Pin)			
Material	Case	Brass-nickel plated			
	Sensing surface	PBT			
	Cable	Standard cable is PVC dia 4 mm.			
Weight (packaged)	Pre-wired models	Approx. 65 g			
	Connector models	Approx. 20 g			

**Note 1.** The response frequency is an average value. Measurement conditions are as follows: standard target, twice the standard target distance between targets, and a setting distance of half the sensing distance.



Engineering data (Reference value)

Operating range

M8

E2B-S08

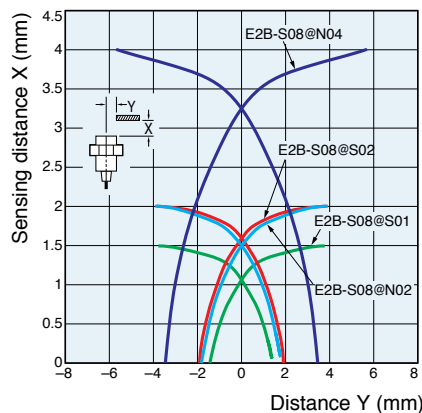

Influence of sensing object size and materials

Shielded models

E2B-S08□S01

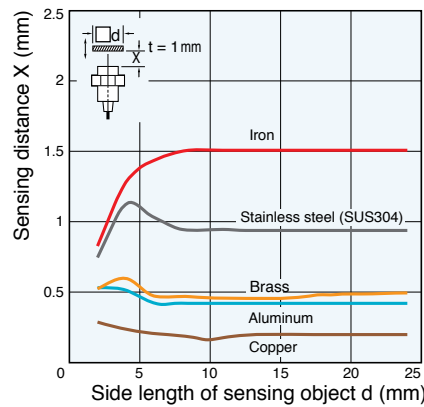

Non-shielded models

E2B-S08□N02

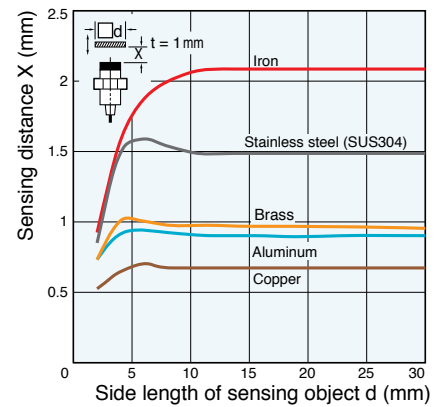

E2B-S08□S02

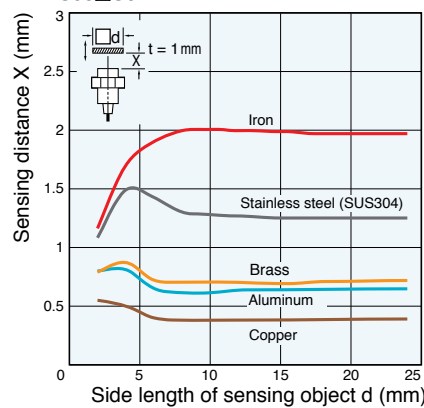

E2B-S08□N04

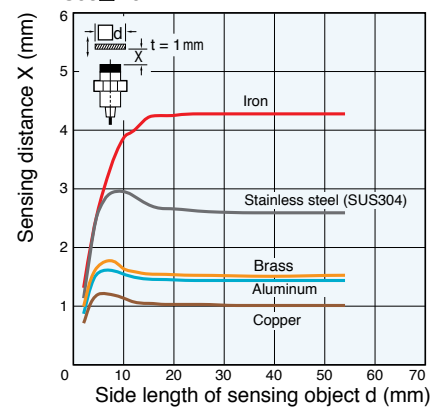

M12

E2B-M12

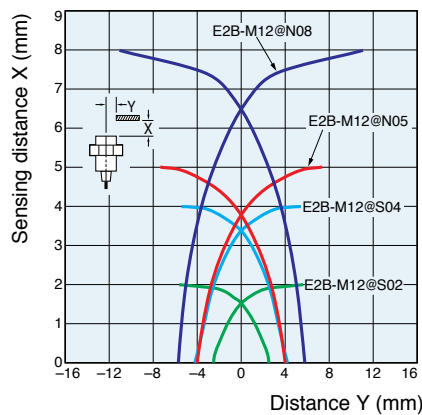

Shielded models

E2B-M12□S02

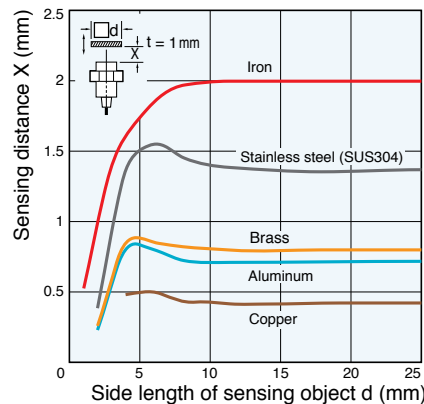

Non-shielded models

E2B-M12□N05

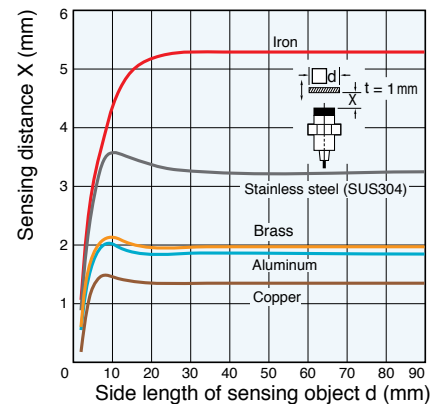

E2B-M12□S04

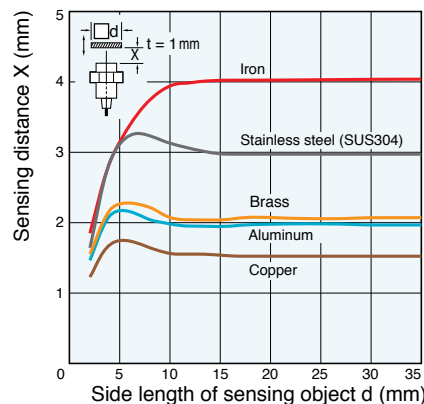

E2B-M12□N08

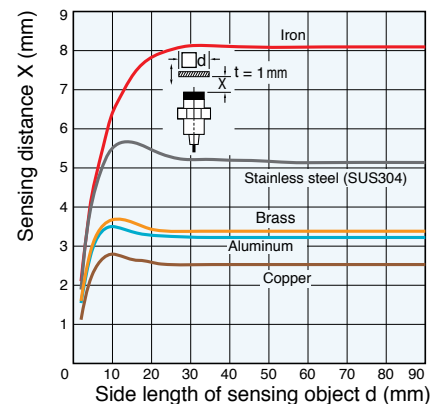

Operating range

M18

E2B-M18

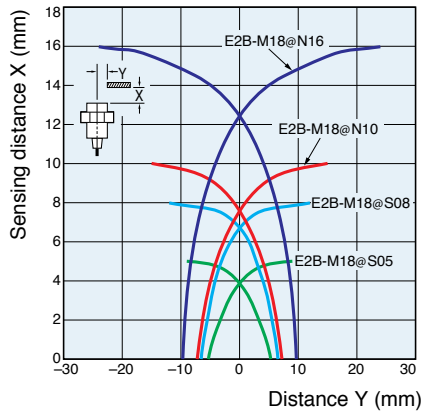

Influence of sensing object size and materials

Shielded models

E2B-M18□S05

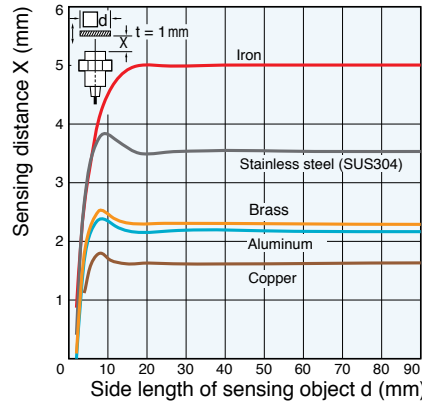

Non-shielded models

E2B-M18□N10

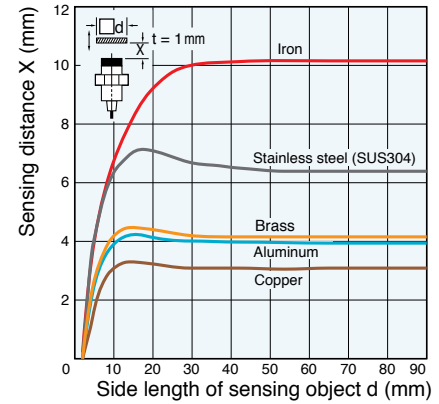

E2B-M18□S08

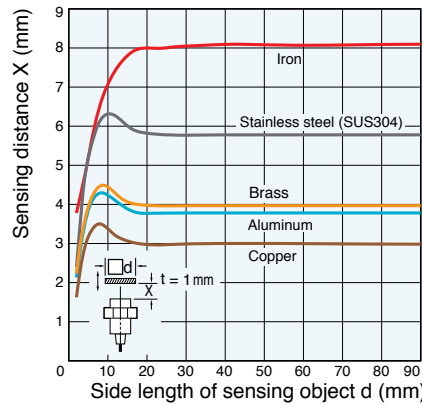

E2B-M18□N16

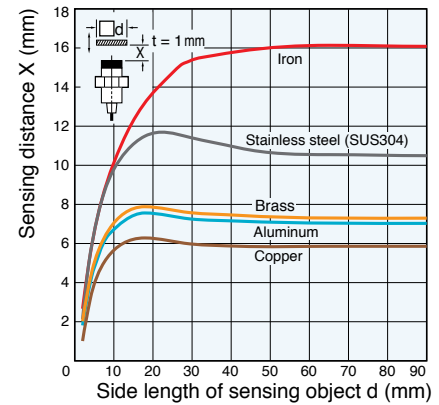

M30

E2B-M30

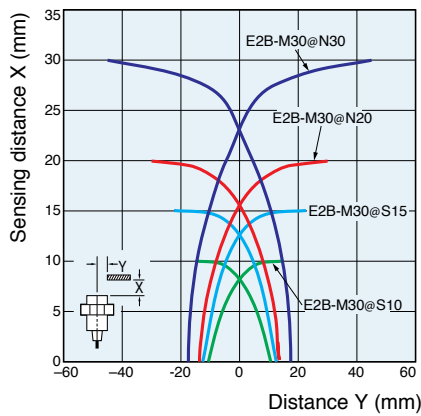

Shielded models

E2B-M30□S10

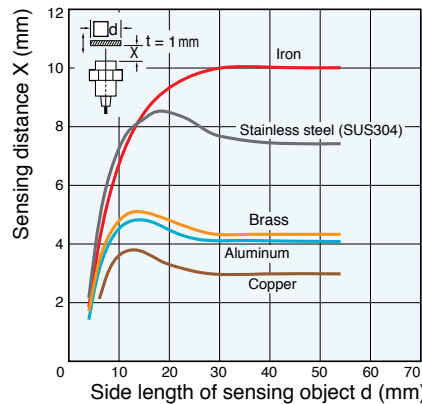

Non-shielded models

E2B-M30□N20

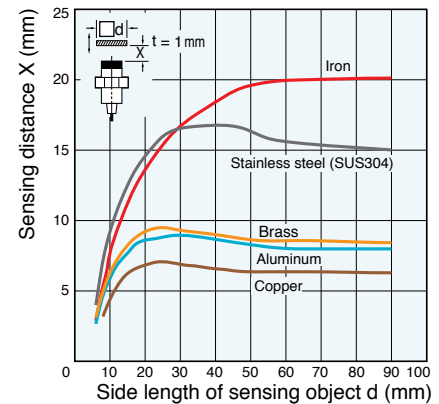

E2B-M30□S15

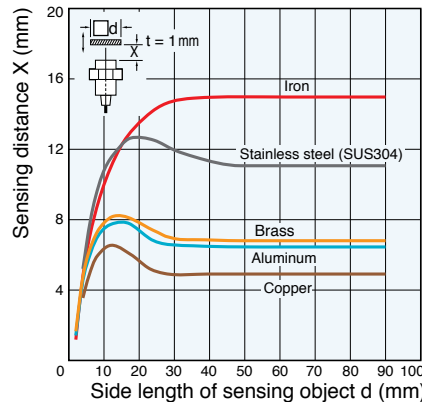

E2B-M30LN30

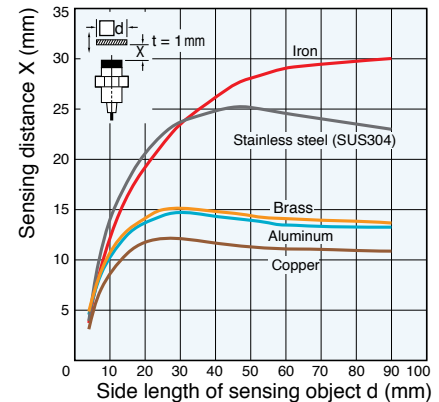

# I/O Circuit Diagrams

## PNP Output

Operation mode	Model	Timing chart	Output circuit
NO	E2B-S08□-□-B□	<p>Non-sensing zone    Sensing zone    Proximity Sensor</p> <p>Sensing object</p> <p>(%)    100    0</p> <p>Rated sensing distance</p> <p>ON Yellow indicator</p> <p>OFF</p> <p>ON Control output</p> <p>OFF</p>	<p>10 to 30 VDC</p>
NC		<p>Non-sensing zone    Sensing zone    Proximity Sensor</p> <p>Sensing object</p> <p>(%)    100    0</p> <p>Rated sensing distance</p> <p>ON Yellow indicator</p> <p>OFF</p> <p>ON Control output</p> <p>OFF</p>	<p>M8 connector (3 pin) Pin Arrangement</p>
NO	E2B-M12□-□-B□ E2B-M18□-□-B□ E2B-M30□-□-B□	<p>Non-sensing zone    Sensing zone    Proximity Sensor</p> <p>Sensing object</p> <p>(%)    100    0</p> <p>Rated sensing distance</p> <p>ON Yellow indicator</p> <p>OFF</p> <p>ON Control output</p> <p>OFF</p>	<p>10 to 30 VDC</p> <p>④ : NO ② : NC</p>
NC		<p>Non-sensing zone    Sensing zone    Proximity Sensor</p> <p>Sensing object</p> <p>(%)    100    0</p> <p>Rated sensing distance</p> <p>ON Yellow indicator</p> <p>OFF</p> <p>ON Control output</p> <p>OFF</p>	<p>M12 Connector (4 pin) Pin Arrangement</p>



Dimensions

M8 size

Pre-wired models (Shielded)

Short body

E2B-S08KS01-WP-□□/E2B-S08KS02-WP-□□

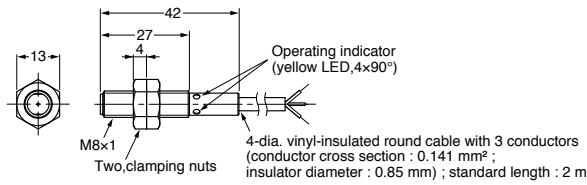

Pre-wired models (Non-shielded)

E2B-S08KN02-WP-□□/E2B-S08KN04-WP-□□

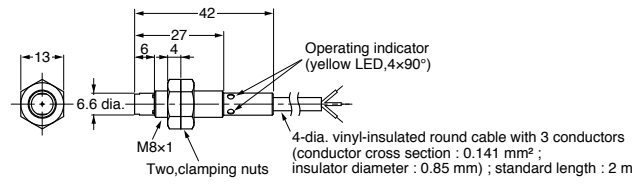

Long body

E2B-S08LS01-WP-□□/E2B-S08LS02-WP-□□

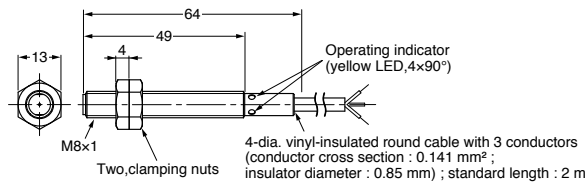

E2B-S08LN02-WP-□□/E2B-S08LN04-WP-□□

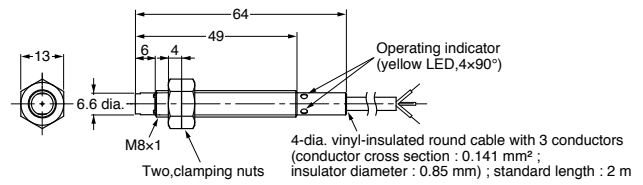

Connector models (Shielded)

Short body

E2B-S08KS01-MC-□□/E2B-S08KS02-MC-□□

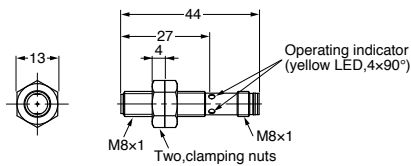

Connector models (Non-shielded)

E2B-S08KN02-MC-□□/E2B-S08KN04-MC-□□

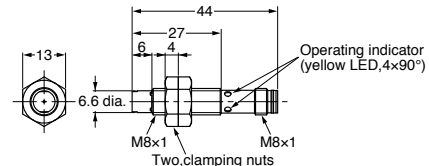

Long body

E2B-S08LS01-MC-□□/E2B-S08LS02-MC-□□

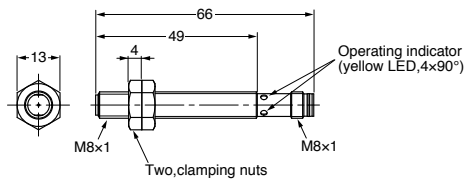

E2B-S08LN02-MC-□□/E2B-S08LN04-MC-□□

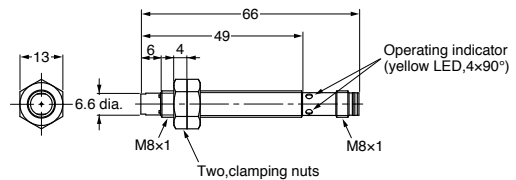

Mounting Hole Cutout Dimensions

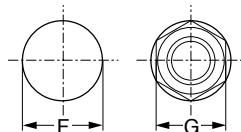

External diameter of Proximity Sensor	Dimension F (mm)	Dimension G (mm)
M8	8.5 dia. <sup>+0.5</sup> <sub>0</sub>	13

M12 size

Pre-wired models (Shielded)

Short body

E2B-M12KS02-WP-□□/E2B-M12KS04-WP-□□

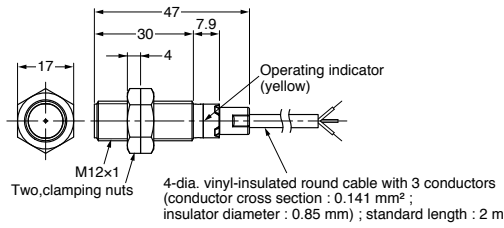

Pre-wired models (Non-shielded)

E2B-M12KN05-WP-□□/E2B-M12KN08-WP-□□

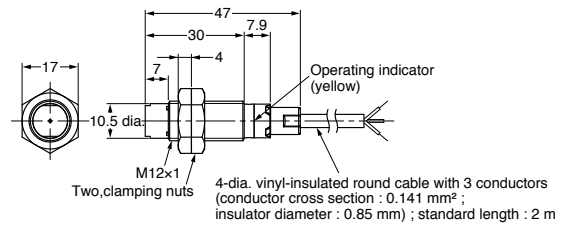

Long body

E2B-M12LS02-WP-□□/E2B-M12LS04-WP-□□

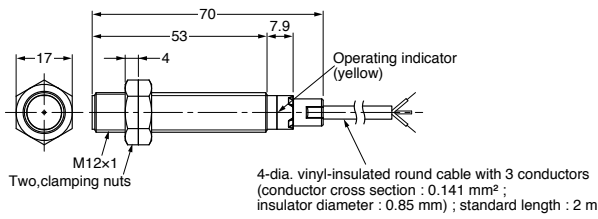

E2B-M12LN05-WP-□□/E2B-M12LN08-WP-□□

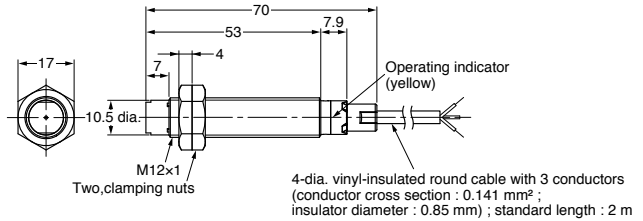

Connector models (Shielded)

Short body

E2B-M12KS02-M1-□□/E2B-M12KS04-M1-□□

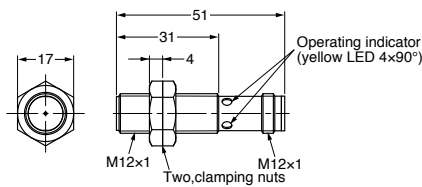

Connector models (Non-shielded)

E2B-M12KN05-M1-□□/E2B-M12KN08-M1-□□

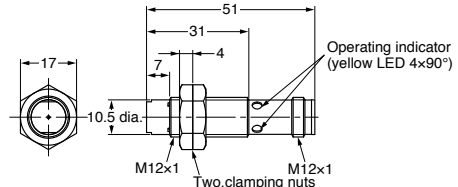

Long body

E2B-M12LS02-M1-□□/E2B-M12LS04-M1-□□

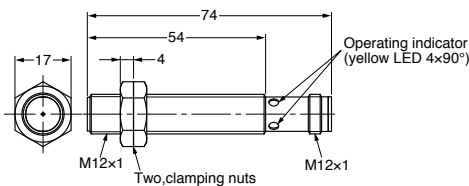

E2B-M12LN05-M1-□□/E2B-M12LN08-M1-□□

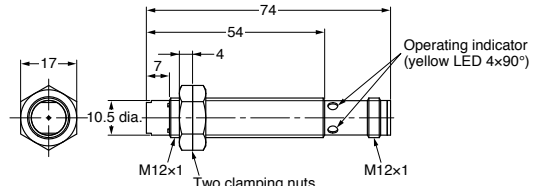

Mounting Hole Cutout Dimensions

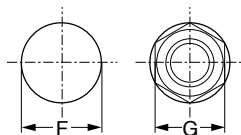

External diameter of Proximity Sensor	Dimension F (mm)	Dimension G (mm)
M12	12.5 dia. <sup>+0.5</sup> <sub>0</sub>	17

## M18 size

### Pre-wired models (Shielded)

#### Short body

E2B-M18KS05-WP-□□/E2B-M18KS08-WP-□□

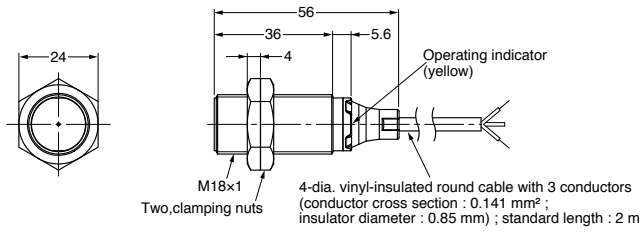

### Pre-wired models (Non-shielded)

E2B-M18KN10-WP-□□/E2B-M18KN16-WP-□□

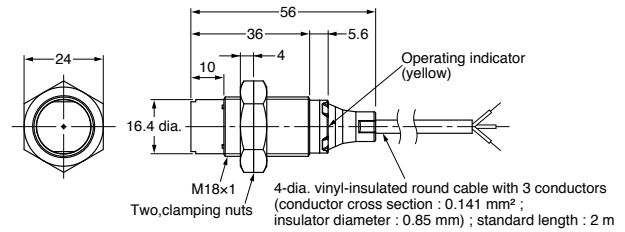

#### Long body

E2B-M18LS05-WP-□□/E2B-M18LS08-WP-□□

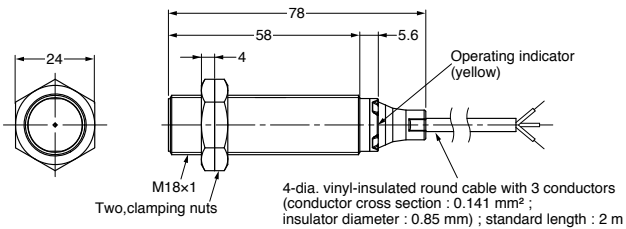

E2B-M18LN10-WP-□□/E2B-M18LN16-WP-□□

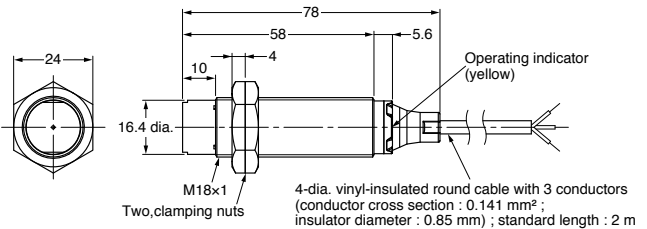

### Connector models (Shielded)

#### Short body

E2B-M18KS05-M1-□□/E2B-M18KS08-M1-□□

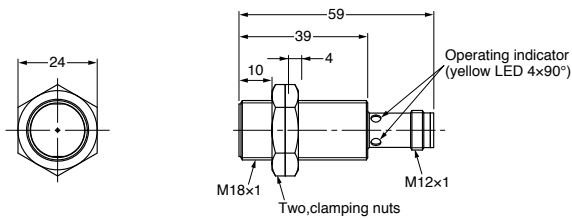

### Connector models (Non-shielded)

E2B-M18KN10-M1-□□/E2B-M18KN16-M1-□□

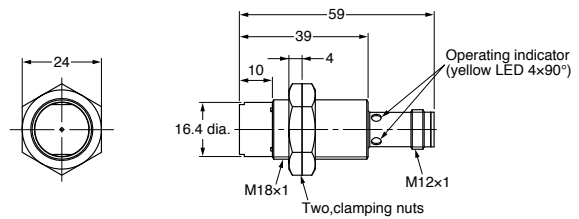

#### Long body

E2B-M18LS05-M1-□□/E2B-M18LS08-M1-□□

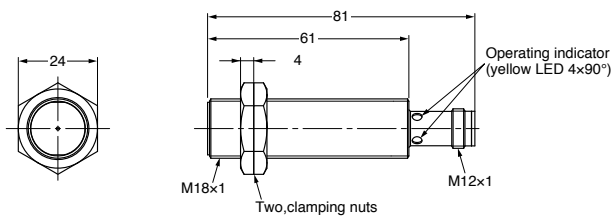

E2B-M18LN10-M1-□□/E2B-M18LN16-M1-□□

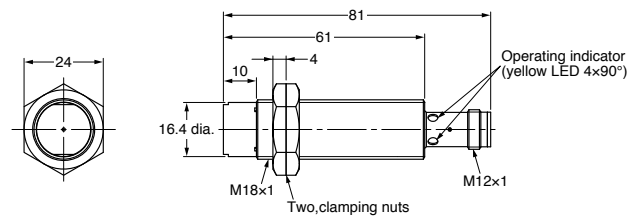

### Mounting Hole Cutout Dimensions

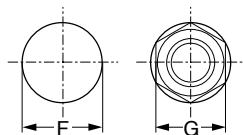

External diameter of Proximity Sensor	Dimension F (mm)	Dimension G (mm)
M18	18.5 dia. <sup>+0.5</sup> <sub>0</sub>	24

M30 size

Pre-wired models (Shielded)

Short body

E2B-M30KS10-WP-□□/E2B-M30KS15-WP-□□

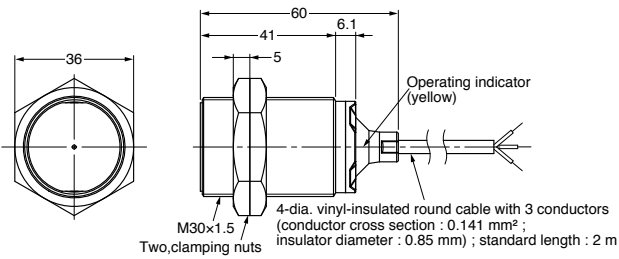

Pre-wired models (Non-shielded)

E2B-M30KN20-WP-□□

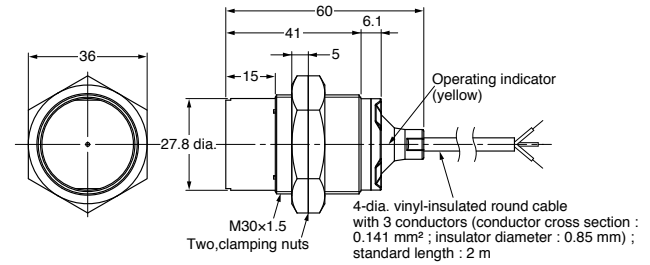

Long body

E2B-M30LS10-WP-□□/E2B-M30LS15-WP-□□

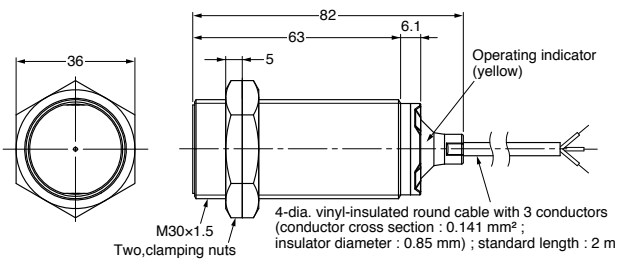

E2B-M30LN20-WP-□□/E2B-M30LN30-WP-□□

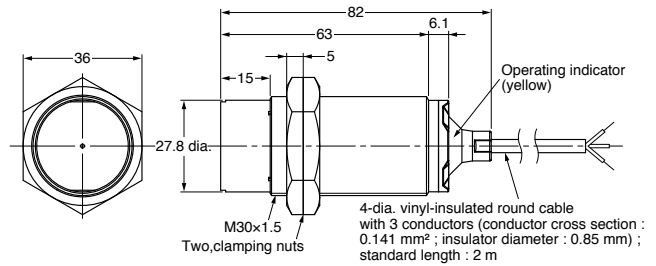

Connector models (Shielded)

Short body

E2B-M30KS10-M1-□□/E2B-M30KS15-M1-□□

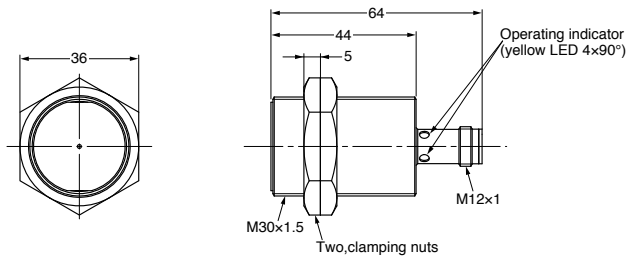

E2B-M30KN20-M1-□□

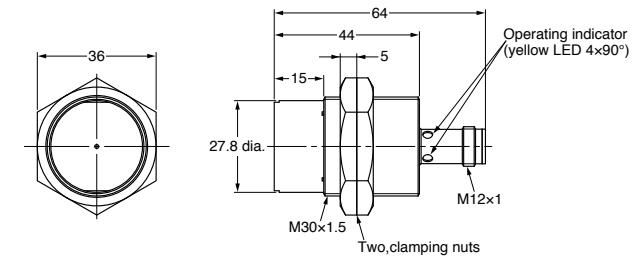

Long body

E2B-M30LS10-M1-□□/E2B-M30LS15-M1-□□

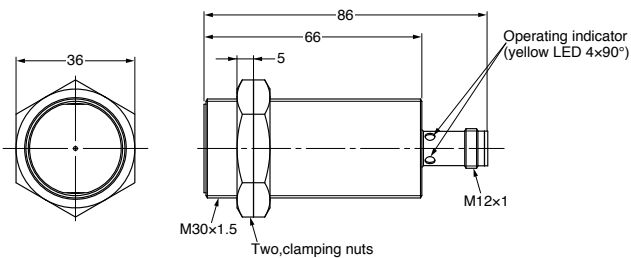

E2B-M30LN20-M1-□□/E2B-M30LN30-M1-□□

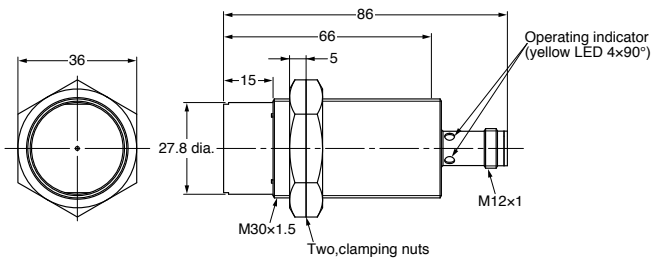

Mounting Hole Cutout Dimensions

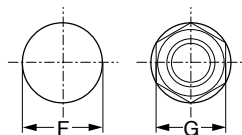

External diameter of Proximity Sensor	Dimension F (mm)	Dimension G (mm)
M30	30.5 dia. <sup>+0.5</sup> <sub>0</sub>	36



Accessories (Order separately)

Sensor I/O connectors

M8 connector (3 pin)

PVC type

(Unit: mm)

Straight

XS3F-M8PVC3S2M (L = 2 m)

XS3F-M8PVC3S5M (L = 5 m)

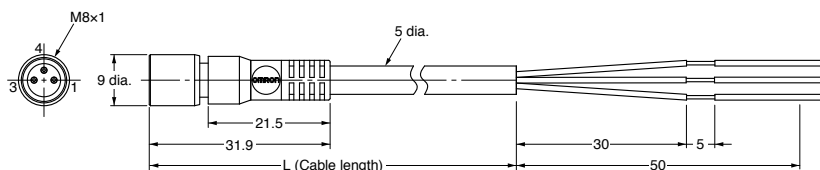

Right-angle

XS3F-M8PVC3A2M (L = 2 m)

XS3F-M8PVC3A5M (L = 5 m)

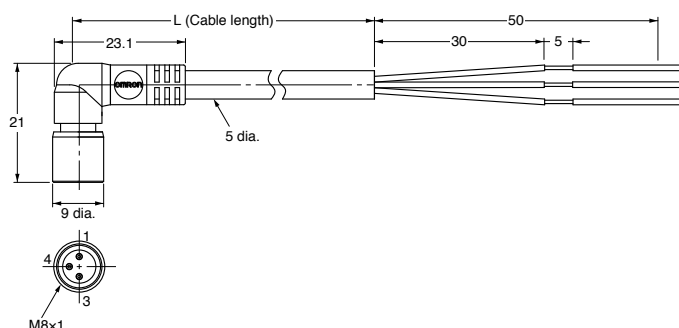

Pin arrangement



- 1-Brown
- 3-Blue
- 4-Black

Sensor I/O connectors

M12 connector (4 pin)

PVC type

Straight

XS2F-M12PVC4S2M (L = 2 m)

XS2F-M12PVC4S5M (L = 5 m)

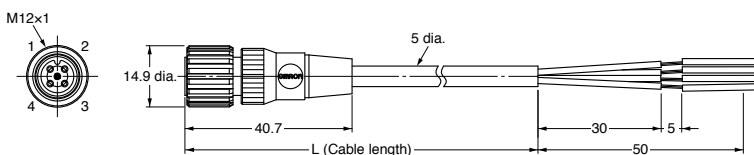

Right-angle

XS2F-M12PVC4A2M (L = 2 m)

XS2F-M12PVC4A5M (L = 5 m)

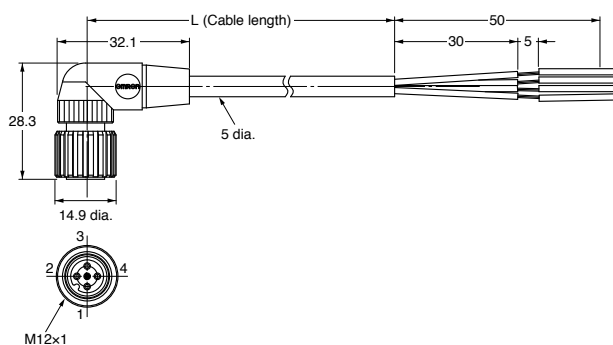

Pin arrangement



- 1-Brown
- 2-White
- 3-Blue
- 4-Black

Precautions

**WARNING**

This product is not designed or rated for ensuring safety of persons. Do not use it for such purposes.



Never use this product with an AC power supply. Otherwise, explosion may result.



Safety precautions

Load short-circuit

Do not short-circuit the load, or the E2B may be damaged. The E2B's short-circuit protection function will be valid if the polarity of the supply voltage imposed is correct and within the rated voltage range.

Correct use

Designing

Power reset time

The Proximity Sensor is ready to operate within 100 ms after power is supplied. If power supplies are connected to the Proximity Sensor and load respectively, be sure to supply power to the Proximity Sensor before supplying power to the load.

Effects of surrounding metal

When mounting the proximity sensor within a metal panel, ensure that the clearances given in the Table1 are maintained. Failure to maintain these distance may cause deterioration in the performance of the sensor.

Table 1

Single sensing distance type

<Shielded>

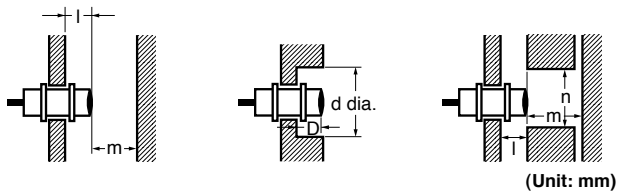

(Unit: mm)

Item	Size			
	M8	M12	M18	M30
l	0	0	0	0
d	8	12	18	30
D	0	0	0	0
m	4.5	8	20	40
n	12	18	27	45

<Non-shielded>

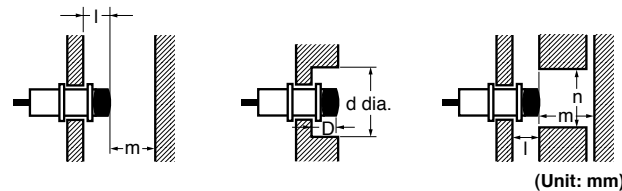

(Unit: mm)

Item	Size			
	M8	M12	M18	M30
l	6	15	22	30
d	24	40	55	90
D	6	15	22	30
m	8	20	40	70
n	24	36	54	90

Double sensing distance type

<Shielded>

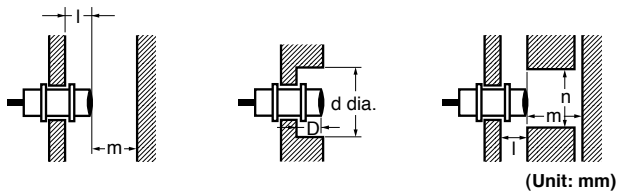

(Unit: mm)

Item	Size			
	M8	M12	M18	M30
l	0	2.4	3.6	6
d	8	18	27	45
D	0	2.4	3.6	6
m	4.5	12	24	45
n	12	18	27	45

<Non-shielded>

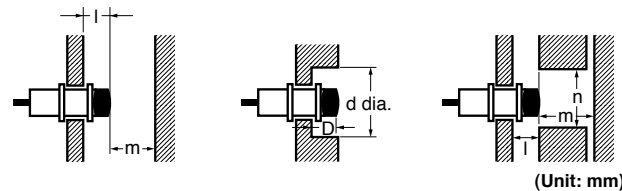

(Unit: mm)

Item	Size			
	M8	M12	M18	M30
l	12	15	25	45
d	24	40	70	140
D	12	15	25	45
m	8	20	48	90
n	24	40	70	140

Wiring

Be sure to wire the E2B and load correctly, otherwise it may be damaged.

Connection with no load

Be sure to insert loads when wiring. Make sure to connect a proper load to the E2B in operation, otherwise it may damage internal elements.

Do not expose the product to flammable or explosive gases.

Do not disassemble, repair, or modify the product.

**Power OFF**

The Proximity Sensor may output a pulse signal when it is turned OFF. Therefore, it is recommended that the load be turned OFF before turning OFF the Proximity Sensor.

**Power supply transformer**

When using a DC power supply, make sure that the DC power supply has an insulated transformer. Do not use a DC power supply with an auto-transformer.

**Mutual interference**

When installing two or more proximity sensors face to face or side by side, ensure that the minimum distances given in the Table2 are maintained.

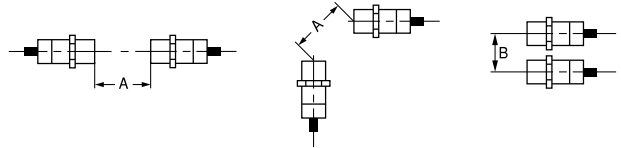

Unit: (mm)

Table 2

Size	M8				M12				M18				M30			
	Shielded		Non-shielded		Shielded		Non-shielded		Shielded		Non-shielded		Shielded		Non-shielded	
Model E2B(-)	S08□S01	S08□S02	S08□N02	S08□N04	M12□S02	M12□S04	M12□N05	M12□N08	M18□S05	M18□S08	M18□N10	M18□N16	M30□S10	M30□S15	M30□N20	M30□N30
A	20	20	80	80	30	30	120	120	50	60	200	200	100	110	300	350
B	15	15	60	60	20	20	100	100	35	35	110	120	70	90	200	300

**Wiring**

**High-tension lines**

Wiring through Metal Conduit:

If there is a power or high-tension line near the cable of the Proximity Sensor, wire the cable through an independent metal conduit to prevent against Proximity Sensor damage or malfunctioning.

**Cable extension**

Standard cable length is less than 200 m.  
The tractive force is 50 N.

**Mounting**

Do not tighten the sensor mounting nuts with excessive force.

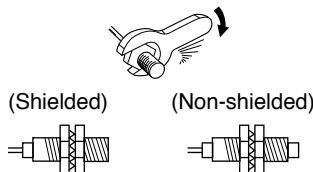

Table 3

Size	Torque
M8	7 N·m
M12	12 N·m
M18	30 N·m
M30	50 N·m

**Maintenance and inspection**

Periodically perform the following checks to ensure stable operation of the Proximity Sensor over a long period of time.

1. Check for mounting position, dislocation, looseness, or distortion of the Proximity Sensor and sensing objects.
2. Check for loose wiring and connections, improper contacts, and line breakage.
3. Check for attachment or accumulation of metal powder or dust.
4. Check for abnormal temperature conditions and other environmental conditions.
5. Check for proper lighting of indicators (for models with a set indicator.)

Never disassemble or repair the Sensor.

**Environment**

**Water resistivity**

The Proximity Sensors are tested intensively on water resistance, but in order to ensure maximum performance and life expectancy avoid immersion in water and provide protection from rain or snow.

**Operating environment**

Ensure storage and operation of the Proximity Sensor within the given specifications.

**Inrush current**

A load that has a large inrush current (e.g., a lamp or motor) will damage the Proximity Sensor, in which case connect the load to the Proximity Sensor through a relay.

**<SUITABILITY FOR USE>**

OMRON shall not be responsible for conformity with any standards, codes, or regulations that apply to the combination of the products in the customer's application or use of the products.

Take all necessary steps to determine the suitability of the product for the systems, machines, and equipment with which it will be used.

**<CHANGE IN SPECIFICATIONS>**

Product specifications and accessories may be changed at any time based on improvements and other reasons. Consult with your OMRON representative at any time to confirm actual specifications of purchased product.

**ALL DIMENSIONS SHOWN ARE IN MILLIMETERS.**  
To convert millimeters into inches, multiply by 0.03937. To convert grams into ounces, multiply by 0.03527.

## OMRON INDUSTRIAL AUTOMATION • THE AMERICAS HEADQUARTERS

Schaumburg, IL USA • 847.843.7900 • 800.556.6766 • [www.omron247.com](http://www.omron247.com)

### OMRON CANADA, INC. • HEAD OFFICE

Toronto, ON, Canada • 416.286.6465 • 866.986.6766 • [www.omron247.com](http://www.omron247.com)

### OMRON ELECTRONICS DE MEXICO • HEAD OFFICE

México DF • 52.55.59.01.43.00 • 001.800.556.6766 • [mela@omron.com](mailto:mela@omron.com)

### OMRON ELECTRONICS DE MEXICO • SALES OFFICE

Apodaca, N.L. • 52.81.11.56.99.20 • 001.800.556.6766 • [mela@omron.com](mailto:mela@omron.com)

### OMRON ELETRÔNICA DO BRASIL LTDA • HEAD OFFICE

São Paulo, SP, Brasil • 55.11.2101.6300 • [www.omron.com.br](http://www.omron.com.br)

### OMRON ARGENTINA • SALES OFFICE

Cono Sur • 54.11.4783.5300

### OMRON CHILE • SALES OFFICE

Santiago • 56.9.9917.3920

### OTHER OMRON LATIN AMERICA SALES

54.11.4783.5300

**OMRON EUROPE B.V.** • Wegalaan 67-69, NL-2132 JD, Hoofddorp, The Netherlands. • Tel: +31 (0) 23 568 13 00

Fax: +31 (0) 23 568 13 88 • [www.industrial.omron.eu](http://www.industrial.omron.eu)

#### *Authorized Distributor:*

#### **Automation Control Systems**

- Machine Automation Controllers (MAC) • Programmable Controllers (PLC)
- Operator interfaces (HMI) • Distributed I/O • Software

#### **Drives & Motion Controls**

- Servo & AC Drives • Motion Controllers & Encoders

#### **Temperature & Process Controllers**

- Single and Multi-loop Controllers

#### **Sensors & Vision**

- Proximity Sensors • Photoelectric Sensors • Fiber-Optic Sensors
- Amplified Photomicrosensors • Measurement Sensors
- Ultrasonic Sensors • Vision Sensors • RFID/Code Readers

#### **Industrial Components**

- Relays • Pushbuttons & Indicators • Limit and Basic Switches • Timers
- Counters • Metering Devices • Power Supplies

#### **Safety**

- Laser Scanners • Safety Mats • Edges and Bumpers
- Programmable Safety Controllers • Light Curtains • Safety Relays
- Safety Interlock Switches

# Mouser Electronics

Authorized Distributor

Click to View Pricing, Inventory, Delivery & Lifecycle Information:

## Omron:

[E2B-M30LN30-M1-C2](#) [E2B-S08KS02-WP-C2 5M](#) [E2B-M18LN16-WP-C2 5M](#) [E2B-M18LS08-M1-C2](#) [E2B-M12KN08-WP-C2 5M](#) [E2B-M12LN08-M1-C2](#) [E2B-M12LN08-WP-B2 5M](#) [E2B-M18KN16-M1-C2](#) [E2B-M18KN16-WP-B2 5M](#) [E2B-S08KN04-WP-C2 5M](#) [E2B-M12LS04-WP-C2 5M](#) [E2B-M30LS15-WP-C2 5M](#) [E2B-S08LS02-WP-B2 5M](#) [E2B-S08KS02-MC-C2](#) [E2B-M30KS15-M1-C2](#) [E2B-M30LN30-WP-B2 5M](#) [E2B-M18KN16-WP-C2 5M](#) [E2B-M18LN16-WP-B2 2M](#) [E2B-M12KN08-WP-B2 2M](#) [E2B-M12LS04-WP-C2 2M](#) [E2B-M30LN30-WP-B2 2M](#) [E2B-M18LN16-M1-C1](#) [E2B-S08KN04-MC-C1](#) [E2B-M30LN30-M1-C1](#) [E2B-M12LS04-WP-B2 5M](#) [E2B-M18LN16-M1-C2](#) [E2B-M30KS15-WP-C2 5M](#) [E2B-S08KN04-MC-C2](#) [E2B-S08KS02-WP-B2 5M](#) [E2B-M12KS04-WP-C2 5M](#) [E2B-M30LS15-WP-B2 5M](#) [E2B-S08LS02-WP-C2 5M](#) [E2B-M18LS08-WP-C2 5M](#) [E2B-M12KN08-M1-C2](#) [E2B-M12LS04-M1-C2](#) [E2B-M30LN30-WP-C2 5M](#) [E2B-S08LS02-MC-C2](#) [E2B-M18KS08-M1-C2](#) [E2B-M12KS04-M1-C2](#) [E2B-M18KS08-WP-B2 5M](#) [E2B-M12KN08-WP-B2 5M](#) [E2B-M12KS04-WP-B2 5M](#) [E2B-M18LS08-WP-B2 5M](#) [E2B-M30KS15-WP-B2 5M](#) [E2B-M18KS08-WP-C2 5M](#) [E2B-S08LN04-MC-C2](#) [E2B-M30LS15-M1-C2](#) [E2B-S08LN04-WP-B2 5M](#) [E2B-M18LN16-WP-B2 5M](#) [E2B-S08LN04-WP-C2 5M](#) [E2B-M12LN08-WP-C2 5M](#) [E2B-S08KN04-WP-B2 5M](#) [E2B-M12LN08-WP-B1 2M](#) [E2B-M18KN16-WP-B1 2M](#) [E2B-M12LN08-M1-B1](#) [E2B-M18KS08-WP-C1 2M](#) [E2B-M18LS08-M1-B1](#) [E2B-M30LS15-WP-B1 2M](#) [E2B-M12KS04-WP-C1 2M](#) [E2B-S08LN04-WP-C1 2M](#) [E2B-M18KN16-WP-C1 5M](#) [E2B-M18KS08-M1-B2](#) [E2B-M12KN08-WP-B1 5M](#) [E2B-M12KS04-WP-C1 5M](#) [E2B-M30LS15-WP-B1 5M](#) [E2B-S08LS02-WP-C1 5M](#) [E2B-M12LS04-WP-B1 5M](#) [E2B-M18KN16-M1-C1](#) [E2B-M18KN16-WP-B2 2M](#) [E2B-M18LS08-M1-C1](#) [E2B-M12LN08-WP-C2 2M](#) [E2B-S08KN04-WP-B2 2M](#) [E2B-S08KS02-WP-B2 2M](#) [E2B-M30KS15-WP-C2 2M](#) [E2B-S08LS02-WP-C1 2M](#) [E2B-M12LN08-WP-C1 2M](#) [E2B-S08KN04-WP-B1 2M](#) [E2B-S08KS02-WP-B1 2M](#) [E2B-M18KN16-M1-B1](#) [E2B-M30KS15-WP-C1 2M](#) [E2B-M18KN16-WP-C1 2M](#) [E2B-M18KS08-WP-B1 2M](#) [E2B-S08KN04-MC-B2](#) [E2B-M30KS15-WP-C1 5M](#) [E2B-M30LN30-M1-B2](#) [E2B-S08KS02-WP-B1 5M](#) [E2B-M18LN16-WP-B1 5M](#) [E2B-S08LN04-WP-C1 5M](#) [E2B-M30KS15-M1-B1](#) [E2B-M30LS15-M1-B1](#) [E2B-S08LN04-MC-B1](#) [E2B-M12KS04-WP-B1 2M](#) [E2B-M30LN30-WP-C1 2M](#) [E2B-S08KS02-MC-B1](#) [E2B-M30LS15-WP-C1 5M](#) [E2B-S08KS02-MC-B2](#) [E2B-S08LS02-WP-B1 5M](#) [E2B-M12LS04-WP-C1 5M](#) [E2B-S08LN04-MC-B2](#) [E2B-S08LN04-WP-B1 5M](#)