

Euro gauge

Electrical contact type pressure gauge (Modular system)

Model: P510 series

Spec. sheet no. PD05-03

Service intended

P510 series are designed for a local reading of measured pressure and equipped with the inductive contact block which allows all the combinations of contacts to be used. The contact block is mounted on the dial. The window is fitted with a knob for external adjustment of the setpoints.



Nominal diameter

100 and 160 mm

Accuracy

±1.0 % of full scale

Scale range (MPa, kPa, bar)

-0.1 ~ 0 to 0 ~ 200 MPa

Working pressure

Steady : 100 % of full scale

Over range protection : 130 % of full scale

Working temperature

Ambient : -40 ~ 65 °C

Fluid : Max. 100 °C

Degree of protection

EN60529/IEC529/IP67

Temperature effect

Accuracy at temperature above and below the reference temperature (20 °C) will be effected by approximately ±0.4 % per 10 °C of full scale



Standard features

Pressure connection

Stainless steel (316SS)

Element

Stainless steel (316SS)

<10 MPa : C type bourdon tube

≥10 MPa : Helical type bourdon tube

Case

Stainless steel (304SS)

Bezel ring

Stainless steel (304SS)

Bayonet type

Window

Polycarbonate

Movement

Stainless steel

Dial

White aluminium with black graduations

Pointer

Black painted aluminium alloy

Conduit connection

M20 x 1.5

Process connection

3/8", 1/2" PT, NPT and PF

Certificates

Pressure equipment directive (2014/68/EU) Annex III Module H

Option

Damping movement

WISE[®]

1. Base model

P510 Electrical contact type pressure gauge

2. Nominal diameter (mm)

- 4 100
- 6 160

3. Type of mounting

- A** Bottom connection, direct
- B** Bottom connection, surface, case mounting plate
- G** Lower back connection, direct, only available with diameter 100 mm
- N** Lower back connection, flush, cover mounting plate, only available with diameter 100 mm

4. Contact function

- 1 High alarm, normal open contact
- 2 Low and High alarm
- 3 Low alarm, normal close contact
- 4 Two high alarm
- 5 Two low alarm
- 6 Failsafe high and low alarm

5. Process connection

- D** 3/8"
- E** 1/2"

6. Connection type

- B** PF
- C** PT
- D** NPT
- Z** Other

7. Unit

- H** bar
- I** MPa
- J** kPa

8. Range

XXX Refer to pressure unit and range table

9. Pressure connection material and dial color

- 3 316SS and 2 colors
- 4 316L SS and 2 colors
- 7 316SS and 3 colors
- 8 316L SS and 3 colors

10. Option

- 0 None
- 1 Accessories
- 2 Damping movement

Sample ordering code

1	2	3	4	5	6	7	8	9	10
P510	4	A	3	D	D	H	XXX	3	0



© WISE Control Inc. All rights reserved. ALL PRODUCT, PRODUCT SPECIFICATIONS AND DATA ARE SUBJECT TO CHANGE WITHOUT NOTICE TO IMPROVE RELIABILITY, FUNCTION OR DESIGN OR OTHERWISE.

P510 : Type of mounting

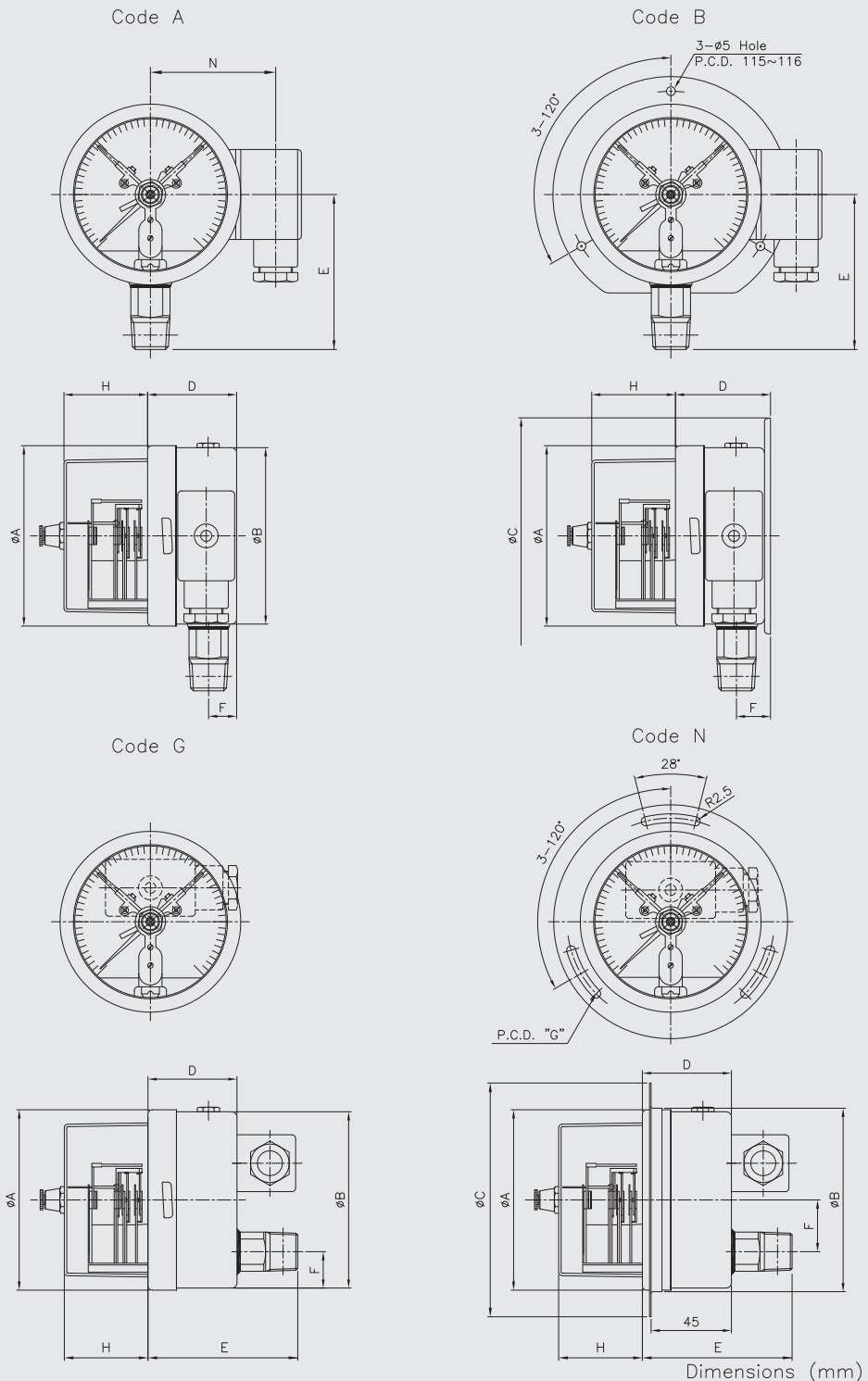

Dial size	Available code	A	B	C	D±2	E±2	F±1	G	H	N
100	A	101.3	99		50	88	16		34.5	75
	B	101.3		133	54.4	88	19.4	116	34.5	
	G	101.3	99		50	88	29		34.5	
	N	101.3	103.1	131	50	88	29	116	34.5	
160	A	160.6	159		52.5	117	15.8		34	105
	B	160.6	159	196	56	117	19.4	178	34	



Snap - action contacts

General

Electromechanical limit switches in pointer type measuring instruments are auxiliary current switches which open or close electrical circuits at set limit values by means of a contact arm which is moved by the actual value pointer.

The snap action contact is a mechanical contact for switching capacities up to 30 W 50 VA max.

Contact making will be delayed and or advanced in relation to the movement of the actual value pointer.

To closed the circuit, the contact pin of the movable contact arm is attracted in a jump by the permanent magnet fastened to the supporting arm shortly before the set value has been reached.

Due to the retention force of the magnet, snap action contacts are more resistant against shock and vibration.

The switching safety is increased by the increased contact pressure.

When the circuit is opened, the magnet keeps the contact arm in its place until the restoring force of the measuring element exceeds the magnetic force, and the contact opens in a jump.

Specifications











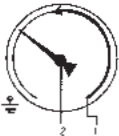

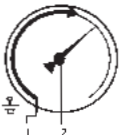

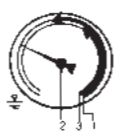
Maximum contact rating with non-inductive (ohmic) load		Electrical contacts type pressure gauge model P510 series	
		Dry gauges	Liquid filled gauges
Maximum voltage		250 V	250 V
Current ratings	Make ratings	1.0 A	1.0 A
	Break ratings	1.0 A	1.0 A
	Continuos load	0.6 A	0.6 A
Maximum load		30 W 50 VA	20 W 20 VA
Material of contact points		Silver-Nickel alloy (80 % Ag / 20 %Ni / 10 μ m) gold-plated	
Ambient operating temperature		-20 °C...+70 °C	
Max. no. of contacts		2	
Voltage test		Circuit / protective earth conductor - 2,000 vac 1 minute	
		Circuit /circuit - 2,000 vac 1 minute	

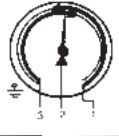
Recommended contact ratings with ohmic and inductive load

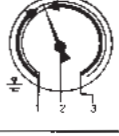
Voltage (DIN IEC 38) DC / AC	Electrical contacts type pressure gauge model P510 series					
	Dry gauges			Liquid filled gauges		
	Ohmic load		Inductive load	Ohmic load		Inductive load
	DC	AC		DC	AC	
			cos ϕ > 0.7			cos ϕ > 0.7
V	mA	mA	mA	mA	mA	mA
220 / 230	100	120	65	65	90	40
110 / 110	200	240	130	130	180	85
48 / 48	300	450	200	190	330	130
24 / 24	400	600	250	250	450	150

In order to ensure a high switching reliability of the contacts the switching voltage should not be below 24 V, also taking environmental influences in the long term into account.

Contact function table

CODE	Wiring Scheme	Contact Function		Wiebrock Code No.	Remark	
		1st Contact	2nd Contact			
Single Contact						
1	Contact make when pointer reachse setpoint (Normal open - NO)				S/M-1	Normal use high alarm system
3	Contact break when pointer reachse setpoint (Normal close - NC)				S/M-2	Normal use low alarm system
Double Contact - Common Circuit						
4	1 st and 2 nd contact make when pointer reaches setpoint				S/M-11	Normal use two high alarm system
6	1 st contact make 2 nd contact break when pointer reaches setpoint				S/M-12	Normal use failsafe high and low alarm system
2	1 st contact break 2 nd contact make when pointer reaches setpoint				S/M-21	Normal use Low and High alarm system
5	1 st and 2 nd contact break when pointer reaches setpoint				S/M-22	Normal use two low alarm system

Terminal block arrangement

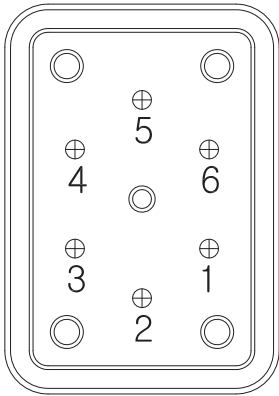

1. High alarm (S/M-1)

- ① Normal open
- ② Common
- ④ Ground

2. Low and high alarm (S/M-21)

Low alarm

- ① Normal close
- ② Common
- ④ Ground

High alarm

- ② Common
- ③ Normal open

3. Low alarm (S/M-2)

- ① Normal close
- ② Common
- ④ Ground

4. Two high alarm (S/M-11)

No.1 High alarm

- ① Normal open
- ② Common
- ④ Ground

No.2 High alarm

- ② Common
- ③ Normal open

5. Two low alarm (S/M-22)

No.2 Low alarm

- ① Normal close
- ② Common
- ④ Ground

No.1 Low alarm

- ② Common
- ③ Normal close

6. Failsafe high and low alarm (S/M-12)

High alarm

- ② Common
- ③ Normal close
- ④ Ground

Low alarm

- ① Normal open
- ② Common

Pressure unit and range table

Range and code	Unit and code			100 mm	160 mm
	H : bar	I : MPa	J : kPa		
026	-1 ~ 0	-0.1 ~ 0	-100 ~ 0	O	O
041	0 ~ 1	0 ~ 0.1	0 ~ 100	O	O
133	0 ~ 1.6	0 ~ 0.16	0 ~ 160	O	O
042	0 ~ 2	0 ~ 0.2	0 ~ 200	O	O
134	0 ~ 2.5	0 ~ 0.25	0 ~ 250	O	O
043	0 ~ 3	0 ~ 0.3	0 ~ 300	O	O
044	0 ~ 4	0 ~ 0.4	0 ~ 400	O	O
045	0 ~ 6	0 ~ 0.6	0 ~ 600	O	O
047	0 ~ 10	0 ~ 1	0 ~ 1,000	O	O
050	0 ~ 15	0 ~ 1.5	X	O	O
143	0 ~ 16	0 ~ 1.6	X	O	O
051	0 ~ 20	0 ~ 2	X	O	O
052	0 ~ 25	0 ~ 2.5	X	O	O
054	0 ~ 35	0 ~ 3.5	X	O	O
151	0 ~ 40	0 ~ 4	X	O	O
055	0 ~ 50	0 ~ 5	X	O	O
056	0 ~ 60	0 ~ 6	X	O	O
057	0 ~ 70	0 ~ 7	X	O	O
058	0 ~ 100	0 ~ 10	X	O	O
059	0 ~ 150	0 ~ 15	X	O	O
060	0 ~ 160	0 ~ 16	X	O	O
062	0 ~ 250	0 ~ 25	X	O	O
064	0 ~ 350	0 ~ 35	X	O	O
065	0 ~ 400	0 ~ 40	X	O	O
066	0 ~ 500	0 ~ 50	X	O	O
067	0 ~ 600	0 ~ 60	X	O	O
068	0 ~ 700	0 ~ 70	X	O	O
070	0 ~ 1,000	0 ~ 100	X	O	O
074	0 ~ 1,600	0 ~ 160	X	O	O
075	0 ~ 2,000	0 ~ 200	X	O	O
027	-1 ~ 1	-0.1 ~ 0.1	-100 ~ 100	O	O
127	-1 ~ 1.5	-0.1 ~ 0.15	-100 ~ 150	O	O
028	-1 ~ 2	-0.1 ~ 0.2	-100 ~ 200	O	O
029	-1 ~ 3	-0.1 ~ 0.3	-100 ~ 300	O	O
030	-1 ~ 4	-0.1 ~ 0.4	-100 ~ 400	O	O
010	-1 ~ 5	-0.1 ~ 0.5	-100 ~ 500	O	O
031	-1 ~ 6	-0.1 ~ 0.6	-100 ~ 600	O	O
014	-1 ~ 9	-0.1 ~ 0.9	-100 ~ 900	O	O
032	-1 ~ 10	-0.1 ~ 1	-100 ~ 1,000	O	O
033	-1 ~ 15	-0.1 ~ 1.5	-100 ~ 1.5 MPa	O	O
034	-1 ~ 20	-0.1 ~ 2	-100 ~ 2 MPa	O	O
035	-1 ~ 25	-0.1 ~ 2.5	-100 ~ 2.5 MPa	O	O

O : Available X : Not available

Large empty rectangular box for writing a memo.