

Truy cập website <https://plcmitsubishi.com> để có thêm nhiều tài liệu và bài viết hướng dẫn kỹ thuật hay



**MITSUBISHI
ELECTRIC**

Changes for the Better

MELSEC iQ-F Series
iQ Platform-compatible PLC

for a greener tomorrow



The next level of industry

MELSEC iQ-F
series

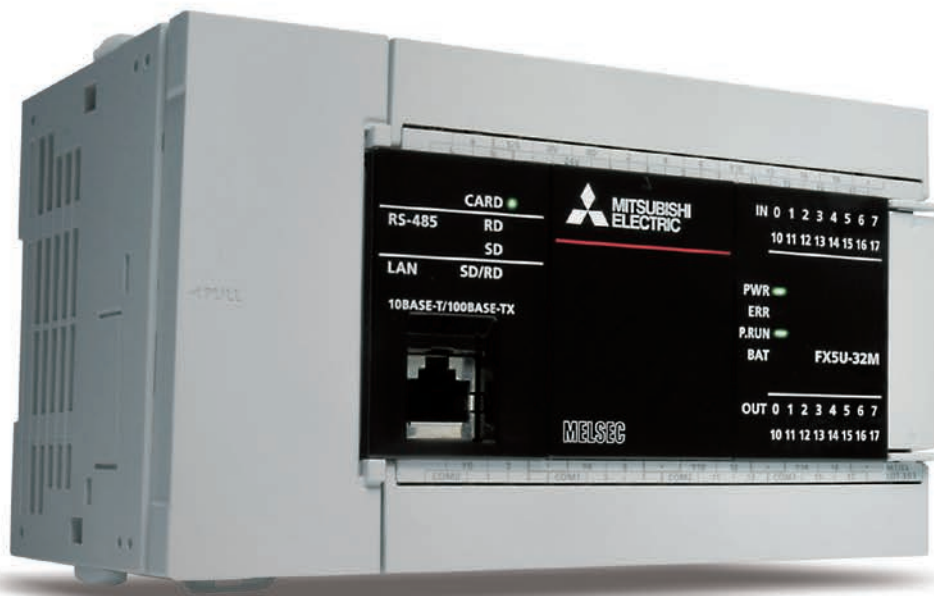

iQ Platform

MELSEC iQ-F series

Designed on the concepts of outstanding performance, superior drive control and user centric programming, Mitsubishi's MELSEC-F Series has been reborn as the MELSEC iQ-F Series.

From stand alone use to networked system applications, MELSEC iQ-F Series brings your business to the next level of industry.

FX5U



FX5UC



The next level of industry

The newly reborn MELSEC iQ-F Series reaches to new areas of application with a high-speed system bus, extensive built-in functions and network support.



Conveyance



Food & Beverage

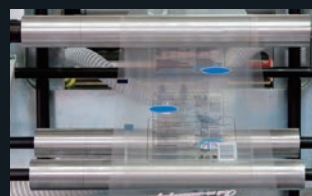

Packaging

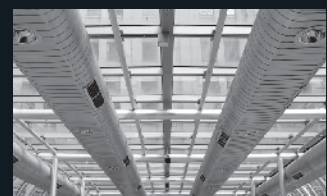

Air-conditioning

New micro PLC designed on the concepts of...



- High-speed system bus
- Extensive built-in functions
- Enhanced security functions
- Battery-less



- Easy built-in positioning (4-axis 200 Kpps)
- Simple interpolation functions
- 4-axis synchronous control with Simple Motion module (dedicated positioning software not needed)



- Easy programming by drag and drop
- Reduced development time with module FB
- Parameterized setup for a variety of functions



GX Works3



iQ Platform

Taking the iQ Platform to the next level.

iQ platform minimizes TCO* by providing innovative solutions for :

- Building a stable production system with enhanced productivity
- Reducing the time from system development to startup for shorter product cycles
- Efficiently managing and servicing the system to reduce down time and maintain productivity
- Ensuring product quality by swiftly processing enormous volumes of control data and production data and establishing traceability

* TCO: Total Cost of Ownership

PLC & HMI

1. MELSEC iQ-F Series greatly enhances the total system performance with the high-speed system bus performance (150× conventional speed *1)
2. Standardize programs with dedicated memory for function blocks and module labels
3. Uniform and powerful security functions

Network

1. Achieve loss-less retrieval with CC-Link IE Field (future support)
1 Gbps high-speed communication (link refresh performance 40× conventional levels *1)
2. Seamless connectivity with each device using SLMP* (future support)

* SLMP: SeamLess Message Protocol

Engineering Environment

1. Detect and automatically generate network configuration diagrams from actual machines (future support)
2. Share parameters across multiple engineering software via MELSOFT Navigator (future support)



* 1: Comparison with FX3U

iQ Platform

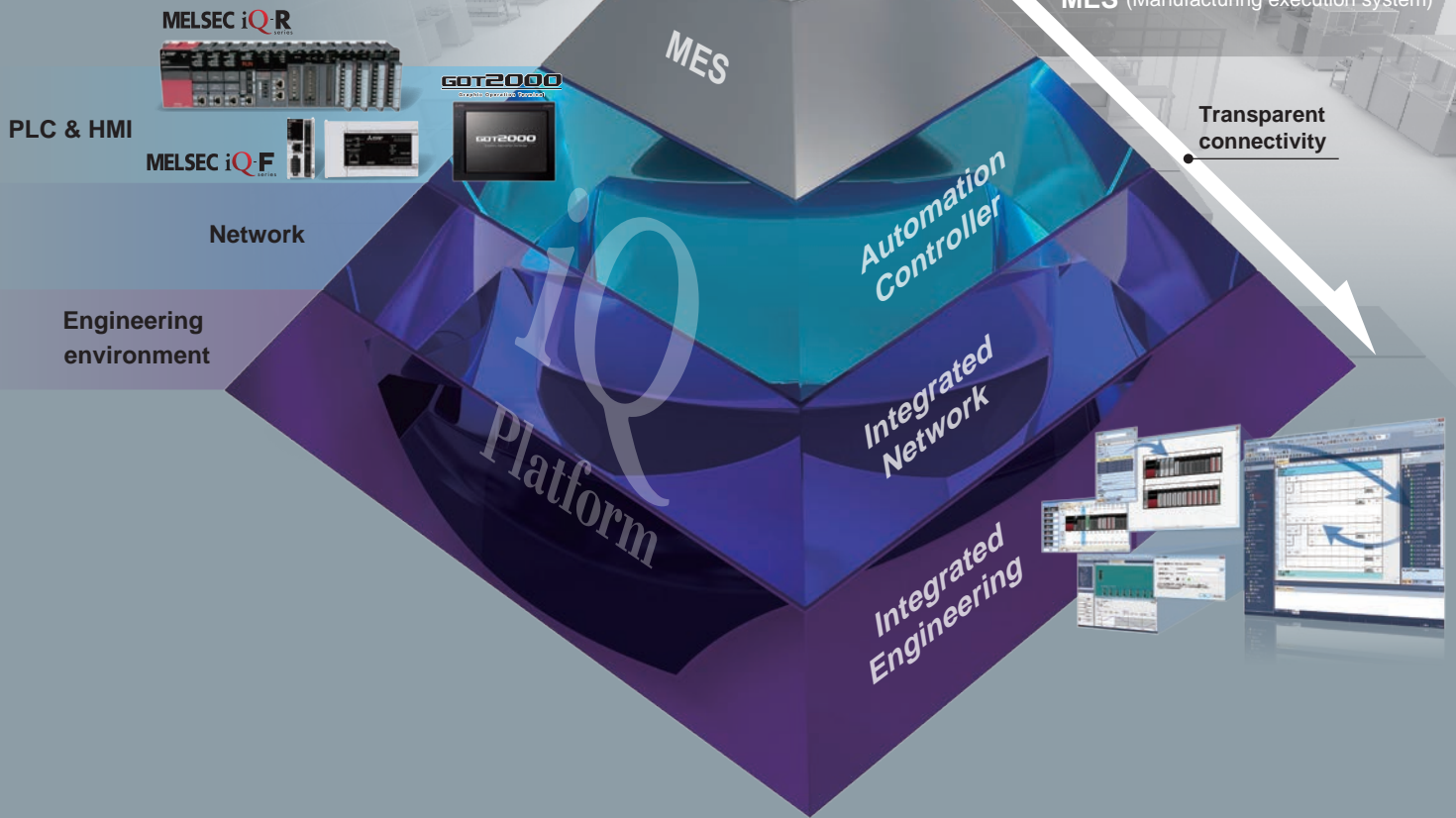

Advanced Built-in Functions

CPU Performance

A new sequence execution engine is at the core of MELSEC iQ-F, capable of running structured programs and multiple programs, and supports structured text and function blocks, etc.

Program capacity 64 k steps	Instruction execution speed (LD, MOV instruction) 34 ns	PC MIX value 14.6 instructions/μs	Fixed cycle interrupt Program minimum 1 ms
---------------------------------------	--	---	--

Built-in Analog Input/Output (with alarm output) FX5U

FX5U is equipped with 12-bit 2ch analog input and 1ch analog output. With parameter setup, no programming is required. Value shifting, scaling and alarm output can also be set easily with parameters.

» Example of inverter control with analog output

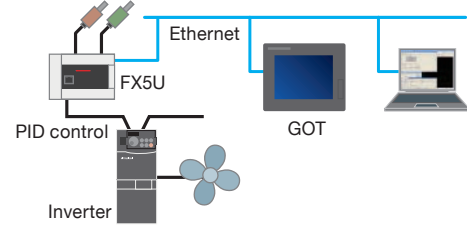

Built-in SD Card Slot

A built-in SD card slot is convenient for updating the program and mass production of equipment. Data can be logged in SD card (future support), making it easy to analyze the system status and production state, etc.

» Example of mass production of equipment using SD card

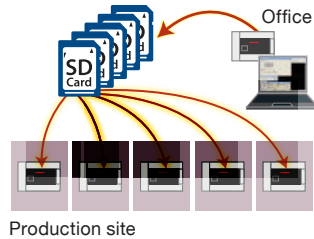

RUN/STOP/RESET Switch

The RUN/STOP switch now includes RESET function. PLC can be rebooted without turning off the main power for efficient debugging.

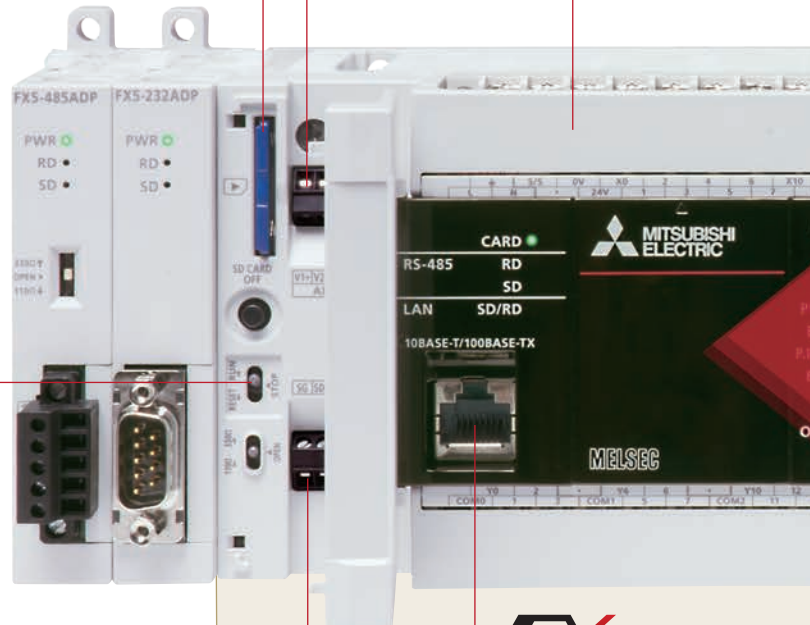

Built-in RS-485 Port (with MODBUS® function)

Connect to serial devices up to 50 m away with built-in RS-485 port. Control for up to 16 Mitsubishi inverters is possible with dedicated inverter communication instructions. The MODBUS function supports a connection of up to 32 peripheral units including PLCs, sensors and thermoregulators.

» Inverter Communication

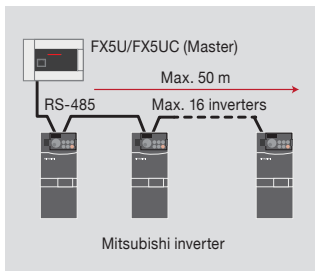

» MODBUS Communication

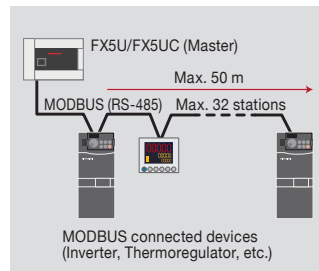

Space saving

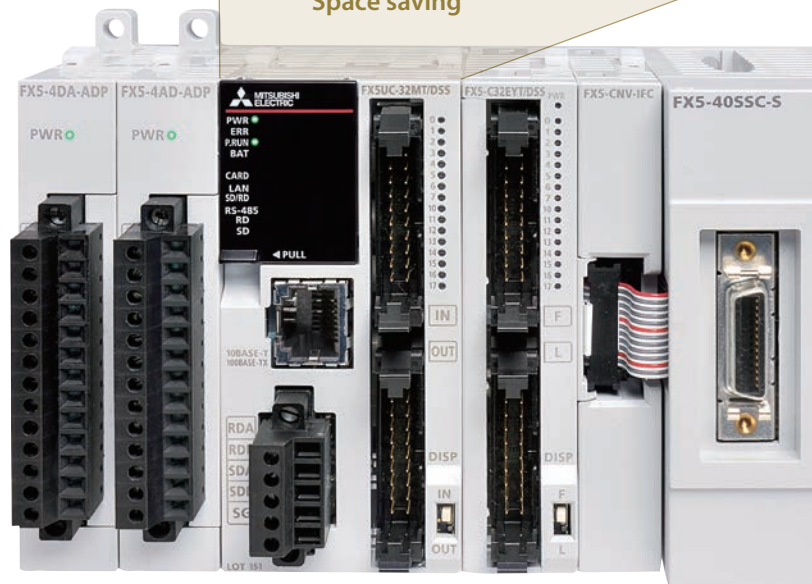

FX5UC

Security

MELSEC iQ-F has advanced security functions (file password, remote password, security key) to prevent data theft and illegal operations by unauthorized persons.

» Example of Security key function

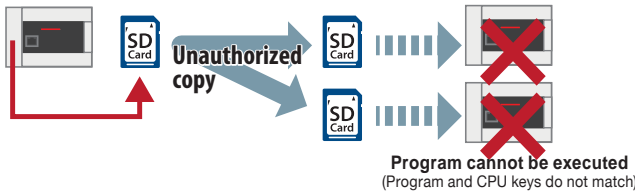

High-speed System Bus Communication

MELSEC iQ-F realizes high-speed system bus communication at speeds of 1.5 k words/ms (approx. 150-times faster than FX3U). Achieve maximum performance even when using intelligent function module with large amounts of data.

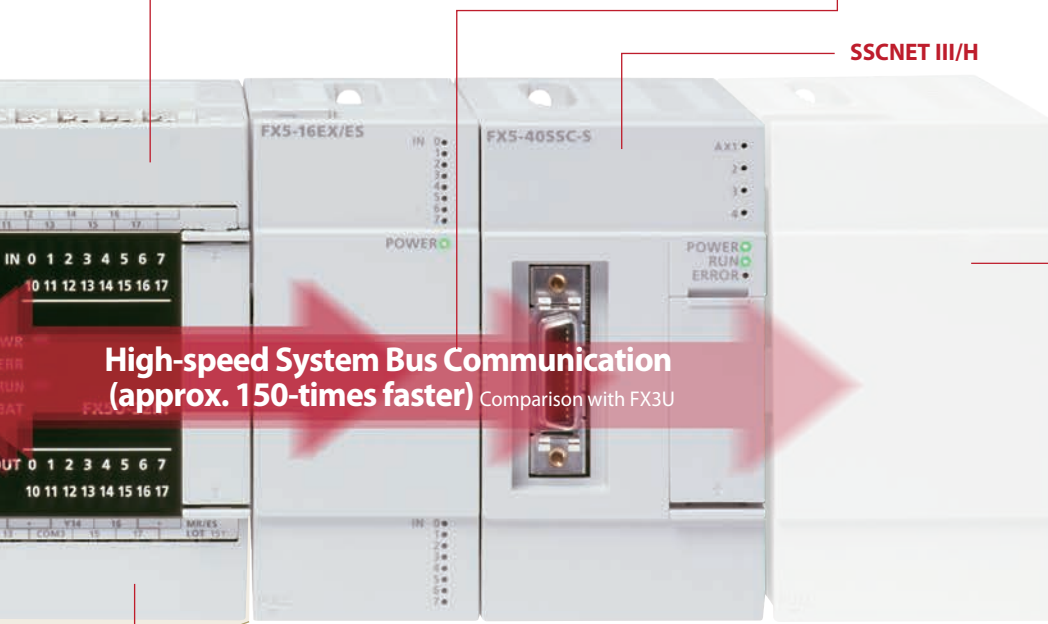

High-speed System Bus Communication
(approx. 150-times faster) Comparison with FX3U

SSCNET III/H

CC-Link IE Field

... Future support

Battery-less and Maintenance-free

Programs can be saved even without a battery, and clock data can be saved for ten days by supercapacitor. (May vary by usage state)

*: Clock data and device memory can be saved (latched) during a power outage by using the optional battery.

Built-in Ethernet Port

The Ethernet communication port can handle communication of up to 8 connections on the network, and can support multiple connections with personal computer and other device. This port also supports remote maintenance and other seamless SLMP communication with host devices.



The CPU module and engineering tool (GX Works3) can be directly connected with a single Ethernet cable.

Ethernet

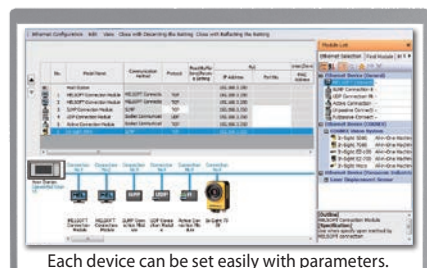

Each device can be set easily with parameters.

» Socket Communication

Directly connect to other PLCs.



» Remote Maintenance

Program read/write can be made by GX Works3 connected via VPN.

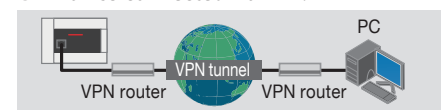

» SLMP Communication

Device data read-out/writing to PLC from external device is possible.

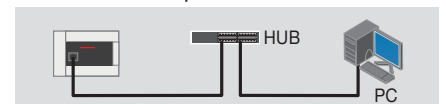

» MODBUS/TCP client

Advanced positioning function

Built-in Positioning (200 Kpps, 4-Axis built-in)

Positioning capable of 20 μ s high-speed start

Up to 8 ch 200 kHz*

FX5U/FX5UC features powerful positioning functionality with 8 ch high-speed pulse input and 4-axis pulse output. Positioning operations including interrupt, variable speed, and simple interpolation can easily be set up in tables and executed.

* FX5U-32M: 6 ch 200 kHz+2 ch 10 kHz
FX5UC-32M: 6 ch 200 kHz+2 ch 10 kHz

1st Axis 200 Kpps
2nd Axis 200 Kpps
3rd Axis 200 Kpps
4th Axis 200 Kpps

[Example of packing system using built-in positioning]

Pulse Output
ON (Forward Rotation) OFF (Reverse Rotation)
Rotation direction

Simple Linear Interpolation (2-Axis simultaneous start)
Y coordinate
Target position (x, y)
Start point
X coordinate

Simple Motion Module <4-Axis control module>

Positioning control with SSCNET III/H

FX5-40SSC-S is equipped with a 4-axis positioning function compatible with SSCNET III/H. By combining linear interpolation, 2-axis circular interpolation and continuous trajectory control in the program set with a table, a smooth trajectory can be easily drawn.

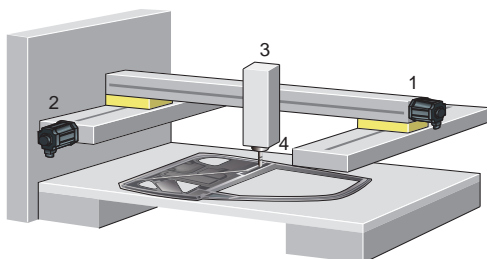

[Example of sealing system]

1. X-axis
2. Y-axis
3. Z-axis
4. Paint

Main functions

- Linear interpolation
- Circular interpolation
- Continuous trajectory control
- S-curve acceleration/deceleration

Application examples

- Sealing system
- Automatic vending machines
- Palletizer
- Grinding system

Advanced Motion Control

Making Simple Motion with compactly packed extra functions

By starting with parameter settings and the sequence program, the Simple Motion modules can realize a variety of motion control including positioning control, advanced synchronous control, cam control and speed-torque control.

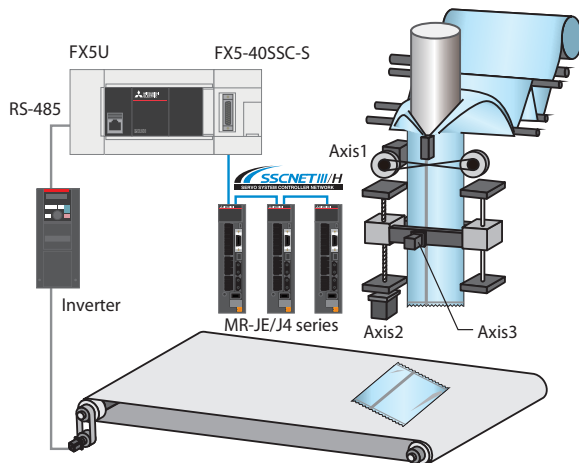

[Example of packaging machine using Simple Motion]

- Use synchronous control and cam control to build a system perfect for your equipment.
- Register up to 64 types of cam patterns to respond to any type of packaging needs.
- Perform continuous operation without stopping the workpiece operation.

Synchronous control

In addition to synchronous control that replaces physical machine mechanisms such as gears, shaft, transmission and cam with software, functions such as cam control, clutch and cam auto-generation are easily realized. Since synchronous control can be started and stopped for each axis, programs can contain both synchronous control axes and positioning control axes.

Up to four axes can be synchronized to the synchronous encoder axis, enabling use with a variety of systems.

Cam data auto-generation

Easily program and automatically generate difficult cam data for rotary cutters just by inputting the sheet length, synchronization width, and cam resolution, etc.

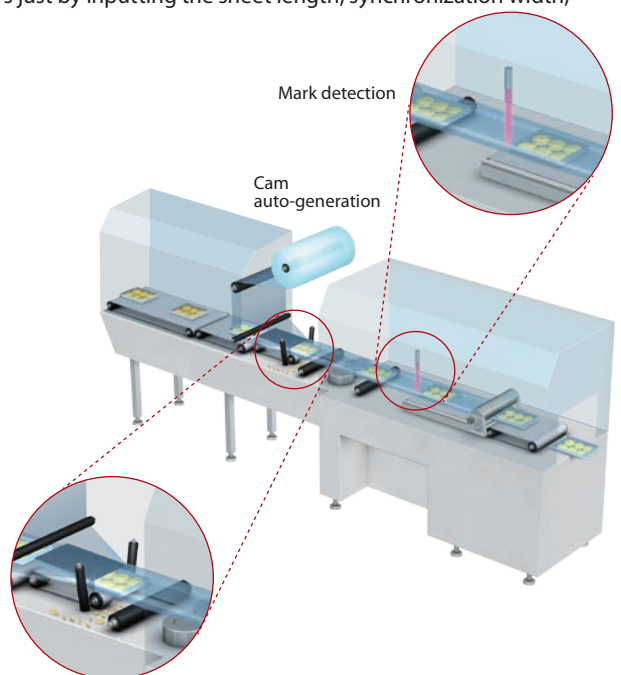
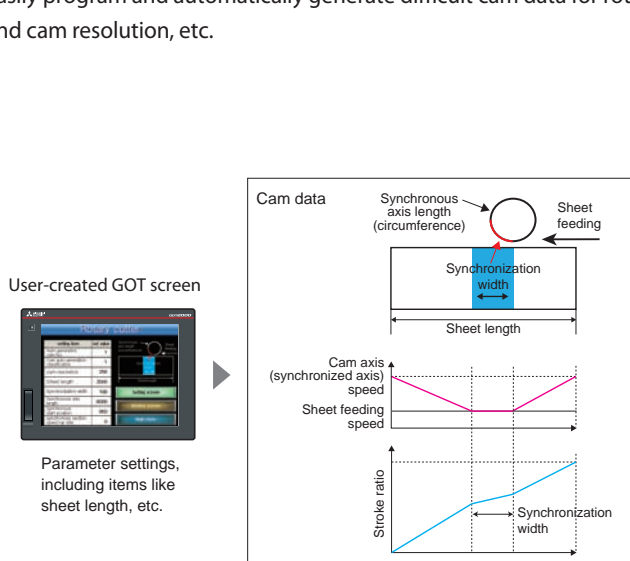

[Example of rotary cutter control with mark detection and cam data]

Mark detection function

The cutter axis deviation can be compensated by detecting a mark on the workpiece so the workpiece can be cut at a constant position.

User-friendly programming software

GX Works3

Software that comprehensively supports programming and maintenance streamlines operations.
Easily and intuitively program by making "selections" in a graphical environment.
Reduce maintenance and engineering costs with diagnosis and troubleshooting function.

System design with a convenient parts library

With GX Works3, designing a system is as easy as preparing the module configuration diagram by dragging and dropping selected parts.

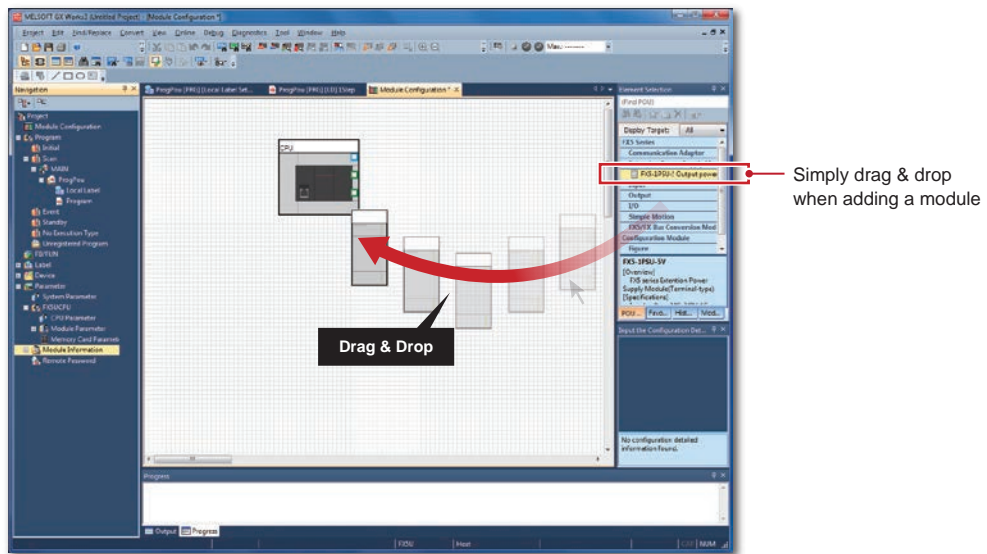

Auto-generation of module parameters

When preparing the module configuration diagram, simply double-click the module to automatically generate the module parameters. A window with an easy-to-use parameter settings screen opens, enabling module parameters to be modified as needed.

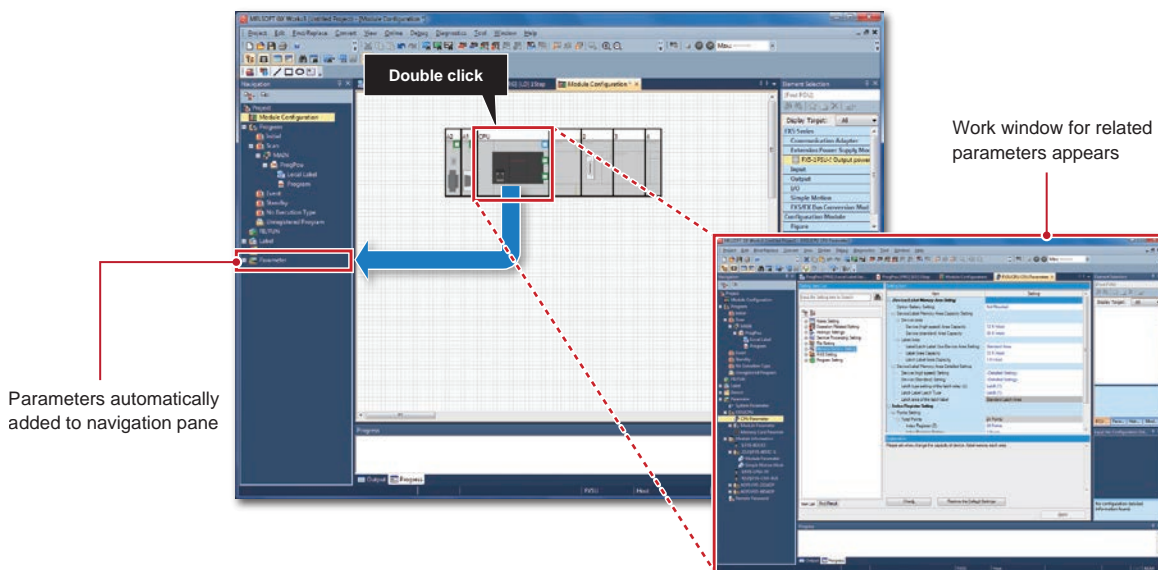

Main programming languages supported

The main IEC languages are supported by GX Works3. Various different programming languages can be used within the same project simultaneously and can be viewed easily via the menu tab.

The labels and devices used in each program can be shared across multiple platforms, with user defined function blocks supported.

Ladder

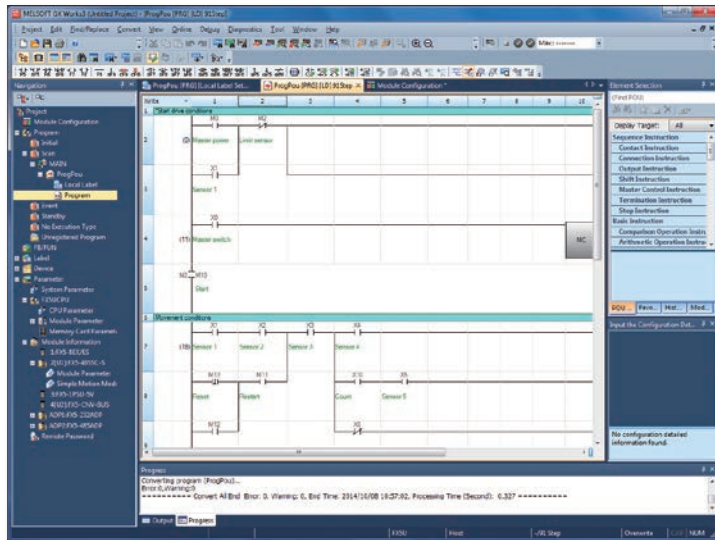

Function block diagram

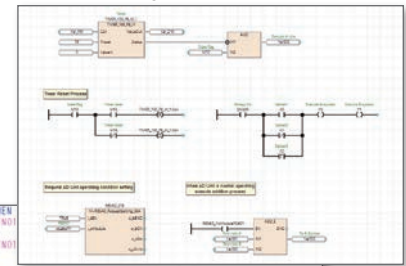

```

1  IF NOT X0 THEN
2  ELSE
3  END_IF;
4
5
6
7  input1 := B001; input2 := K12; input3 := "ABC";
8  // LDFB1 Function Block
9
10 IF NOT X01 AND X02 THEN
11 IF input1 AND X03 THEN
12   OUT_T(T001, T001, 3);
13 ELSEIF NOT input1 AND input2 THEN
14   Y11 := TRUE;
15   OUT_T(T001, T001, 10);
16 ELSE
17   input2 := FALSE;
18   RST(CRUE, T100);
19 END_IF;
20 OUT_XS(OR Z1, Y10);
21 Y10 := FALSE;
22 Y11 := FALSE;
23 IF NOT X03 AND NOT X04 THEN
24   Y10 := input1;
25
26

```

Structured text

Reduce repetitive program tasks

Global labels, local labels and module labels are supported by GX Works3. Global labels can be shared by multiple programs and with other MELSOFT software. Local labels can be used in registered programs and function blocks. Module labels contain buffer memory information for various intelligent function modules and eliminates the need to reference buffer memory address.

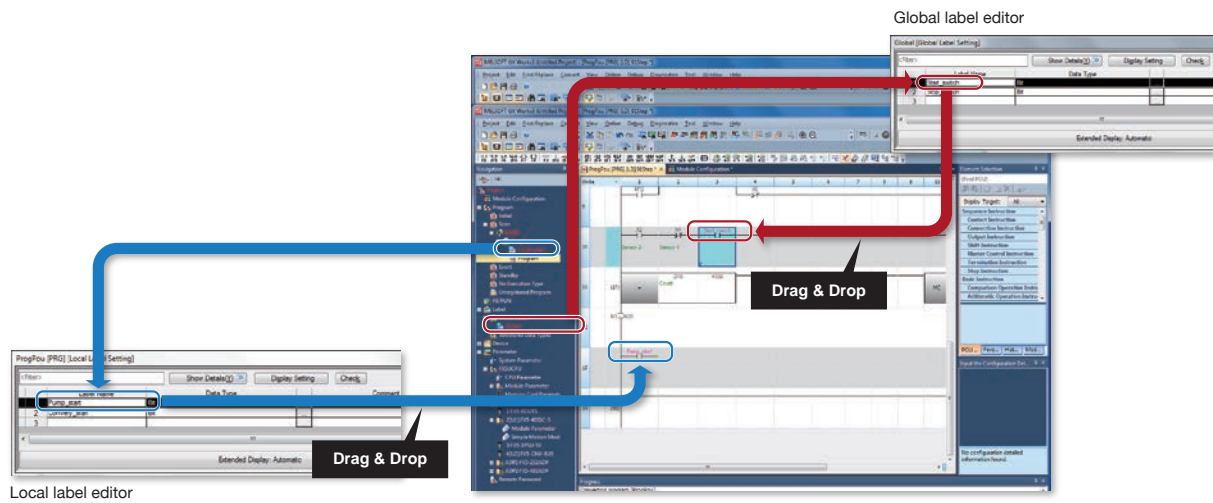

Integrated motion setup tool

GX Works3 is equipped with a special motion setup tool that makes it easy to change simple motion module settings such as module parameters, positioning data and servo parameters. Also, the servo adjustment is simplified using it.

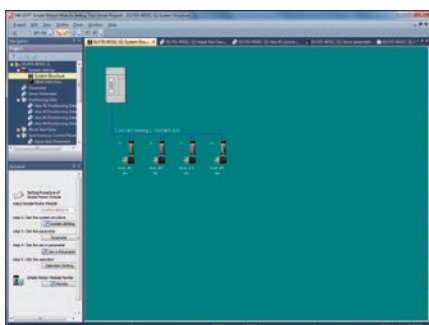

System configuration

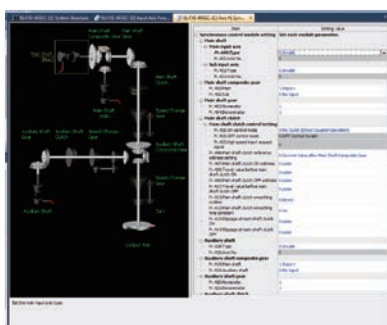

Synchronous control parameter



Digital oscilloscope

Advanced MELSEC iQ-F Series

Simple and convenient parameter settings

With MELSEC iQ-F, various device settings that conventionally had to be programmed can be input in table format.

Easily set the built-in functions as well as expansion devices just by inputting values into the parameters. The program's execution trigger can also be set with the parameters.

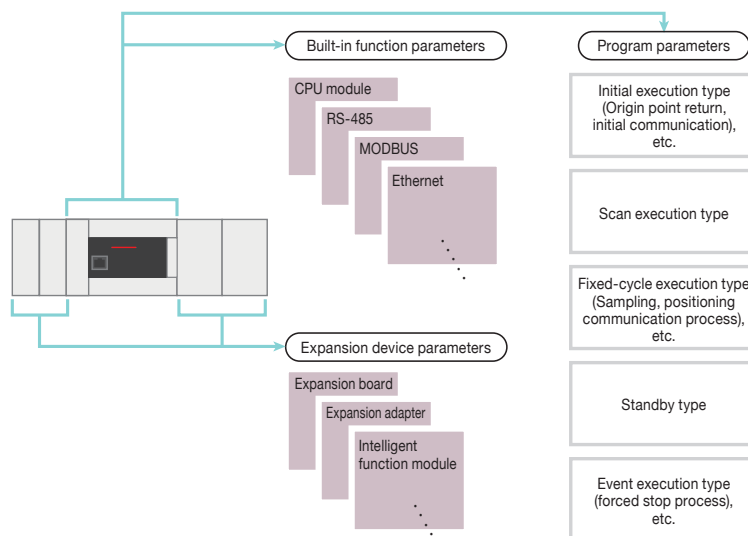

[Functions set with parameters]

- Settings for CPU parameters, Ethernet port, RS-485 communication port, input response time, expansion board, memory card, security, etc.
- Settings for expansion adapters and intelligent function module

Memory area for each application

The CPU module has 64 k steps of program memory capacity, but the MELSEC iQ-F has a memory data area for each application, so all 64 k steps can be used as the program area.

Comments and statements can be written freely without affecting the program area.

[Maximum number of characters]

Comment: 1024 characters Statement: 5000 characters

MELSEC iQ-F Series stores the program and devices in non-volatile memory such as Flash ROM, so no battery is required.

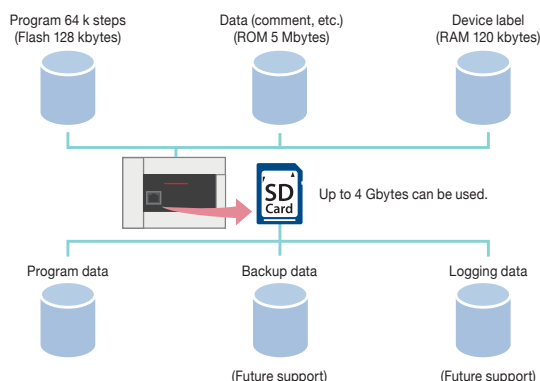

Flexible internal devices

A variety of devices including new latch relays and link relays, and expanded timers and counters are available.

The number of device points can be reassigned and used in the internal memory.

● Providing the convenience of special devices

In addition to the conventional special devices, up to 12000 points of convenient system devices compatible with high-end devices can be added.

New high-end compatible system devices

- SM/SD 0 to 4099
- Compatible with MELSEC iQ-R



Conventional convenient devices

- Conventional M8000 devices → Has changed to SM8000 devices
- Conventional D8000 devices → Has changed to SD8000 devices (When migrating an FX3U/FX3UC program created using GX Works2 to FX5, the devices are automatically converted.)

● Freely customize the latch range setting

The latch range can be set for each device, so the latch clear range can be selected during the clearing operation.

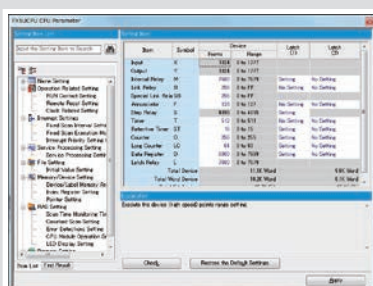

● Handy timer and counter settings

The timer and counter properties are determined by data type and how instruction is written, so programs can be created regardless of the device number.

Timers:

- OUT T0..... 100 ms timer
- OUTH T0 10 ms timer
- OUTHS T0 1 ms timer
- OUT ST0 Retentive timer

Counters:

- OUT C0 16 bit counter
- OUT LC0 32 bit counter

Software

Dramatically more dedicated instructions

A great number of dedicated instructions have been added since the FX3 Series.

[FX3] 510 types **increased to** [FX5] 1014 types



The newly added instructions include convenient ones that are interchangeable with the MELSEC iQ-R and dedicated instructions for built-in functions. (Programs created with GX Works2 can also be read in and converted.)

Intuitive and easy-to-understand arithmetic operations

Symbols can be input in the arithmetic operations making it easy and intuitive to describe programs.

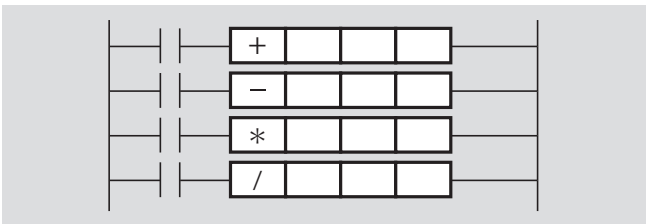

High-performance built-in high-speed counter function

Input and measure three modes by setting the parameters.

- Normal mode
- Pulse density measurement mode
- Rotation speed measurement mode

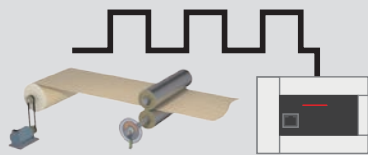

Up to four tables can be set for the high-speed comparison table and up to 128 tables for the multi-point output high-speed comparison table. The HCMOV instruction can be used to read the latest values from the special registers.

Reinforced built-in positioning function

Positioning is easy using table operations. Simple linear interpolation operation is possible by using the positioning instruction DRVTBL with multiple table operation and the multiple axis simultaneous drive positioning instruction DRVMUL.

Diverse table operation settings for multi-speed and interrupt positioning, etc.

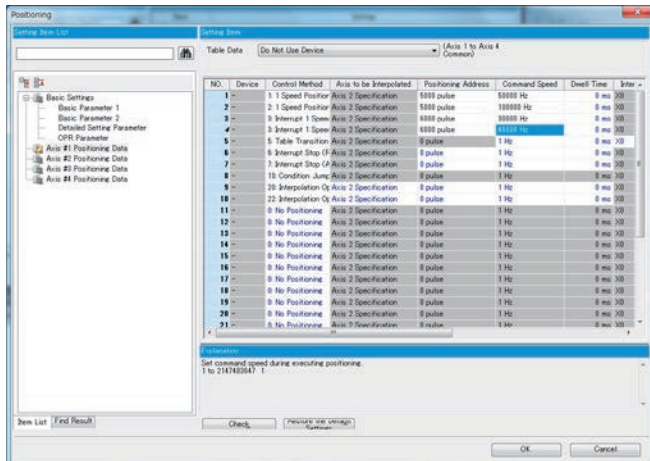

Inverter communication command function

The built-in Mitsubishi inverter protocol makes it possible to use inverter communication instructions to control a Mitsubishi inverter connected with RS-485 communication.

- IVCK : Operation monitor
- IVDR : Operation control
- IVRD : Parameter read
- IVWR : Parameter write
- IVBWR : Parameter batch write
- IVMC : Multiple command (2 types of settings and 2 types of read)

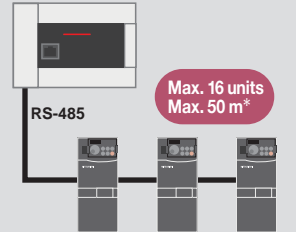

*: For built-in RS-485 communication

Built-in Ethernet function

Communication is set with parameters and programs are made with dedicated instructions.

Functions including the diagnosis function from GX Works3, SLMP function, socket communication function and IP address change function and unauthorized access from an external source can be prevented with remote password.

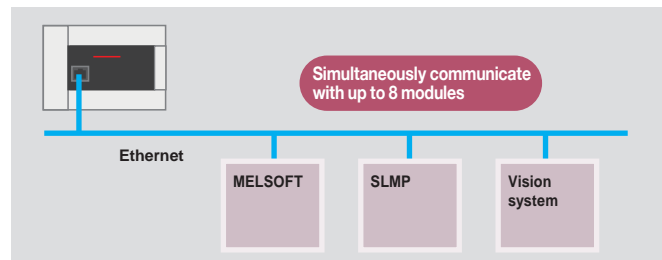

MODBUS function

The MODBUS function can be used with parameter settings and ADPRW (MODBUS master communication instruction [data read/write.]) Communicate with devices up to 1200 m away using the RS-485 communication adapter.

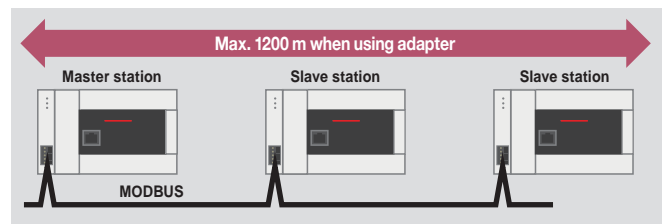

Standard function/function block function

110 types of basic standard function and function blocks are provided. These can be used as parts by dragging and dropping, so when used together with dedicated instructions, programming time can be greatly reduced.

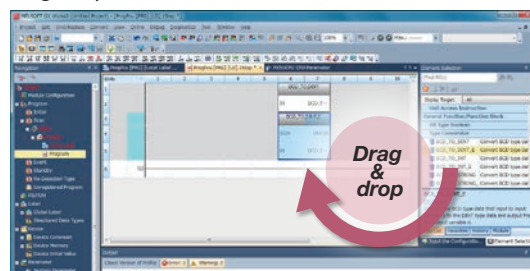

System Configuration

FX5U

Flagship model equipped with advanced built-in functions and diverse expandability

Simplifying use with renewed expansion modules!

FX5U is equipped with analog functions, communication and high-speed I/O, and can easily be expanded with expansion boards and adapters. The high-speed system bus communication brings out the maximum performance of expansion devices equipped with intelligent functions.

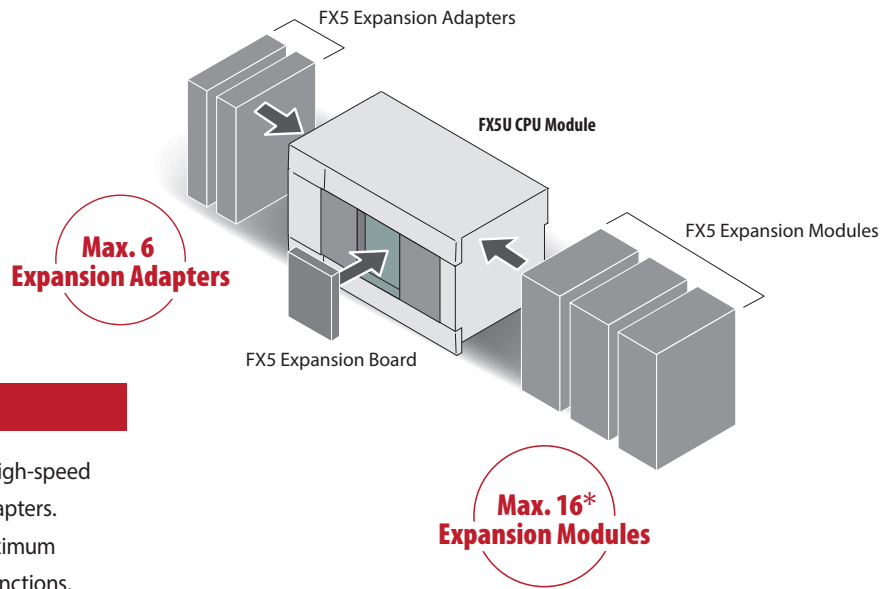

FX5 Expansion Adapters

Max. 2 ch



Communication

FX5-232ADP For RS-232C communication
FX5-485ADP For RS-485 communication

Max. 4 ch



Analog

FX5-4AD-ADP For input
FX5-4DA-ADP For output

FX5 Expansion Boards

Max. 1 ch



Communication

FX5-232-BD For RS-232C communication
FX5-485-BD For RS-485 communication
FX5-422-BD-GOT For RS-422 GOT communication

FX5U CPU Modules



FX5U-32MR/ES
FX5U-32MT/ES
FX5U-32MT/ESS

AC	D	R
AC	D	T1
AC	D	T2



FX5U-64MR/ES
FX5U-64MT/ES
FX5U-64MT/ESS

AC	D	R
AC	D	T1
AC	D	T2



FX5U-80MR/ES
FX5U-80MT/ES
FX5U-80MT/ESS

AC	D	R
AC	D	T1
AC	D	T2

AC AC power supply D DC input (sink/source)
R Relay output T1 Transistor output (sink)
T2 Transistor output (source)







Option

Battery	SD card	Programming software
FX3U-32BL	NZ1MEM-2GBSD (2 GB) NZ1MEM-4GBSD (4 GB)	GX Works3

Generic Specifications

Item	Generic Specifications	
Power supply, input/output	Power supply specifications	100 to 240 V AC 50/60 Hz
	Power consumption	30 W (32M), 40 W (64M), 45 W (80M)
	Rush current	FX5U-32M[]: max. 25 A 5 ms or less/100 V AC, max. 50 A 5 ms or less/200 V AC FX5U-64M[]/FX5U-80M[]: max. 30 A 5 ms or less/100 V AC, max. 60 A 5 ms or less/200 V AC
	5 V DC power supply capacity	900 mA or less (32M), 1100 mA or less (64M, 80M)
	24 V DC power supply capacity	400 mA or less (32M), 600 mA or less (64M, 80M) When using external power supply for CPU module input: 480 mA or less (32M) , 740 mA or less (64M) , 770 mA or less (80M)
	Input specifications	24 V DC, 5.3 mA (X020 and above: 4 mA)
	Output specifications	Relay output type: 2 A/1 point, 8 A/4 points common, 8 A/8 points common 250 V AC (240 V for CE, UL/cUL Standard compliance), 30 V DC or less Transistor output type: 0.5 A/1 point, 0.8 A/4 points, 1.6 A/8 points common 5 to 30 V DC
	Input/output expansion	Expansion device for FX5 can be connected
	Built-in communication port	Ethernet (100BASE-TX/10BASE-T), RS-485 (MELSOFT connection, MC protocol, non-protocol communication, MODBUS RTU, inverter communication, N:N communication)
	Built-in memory card slot	1 slot for SD memory card
Built-in analog input/output	Input 2 ch, output 1 ch	

FX5 Expansion Modules

I/O Modules	Intelligent Function Modules	Extension Power Supply Module
<p>Powered I/O Modules</p>  <p>Powered I/O Modules</p> <p>FX5-32ER/ES FX5-32ET/ES FX5-32ET/ESS</p>	<p>Unpowered I/O Modules</p> <p>Input</p>  <p>FX5-8EX/ES FX5-16EX/ES</p> <p>Output</p>  <p>FX5-8EYR/ES FX5-8EYT/ES FX5-8EYT/ESS FX5-16EYR/ES FX5-16EYT/ES FX5-16EYT/ESS</p>	<p>Simple Motion</p>  <p>FX5-40SSC-S</p>
	<p>Network</p>  <p>CC-Link/IE Field slave ... Future support</p>	<p>Extension Power Supply Module</p>  <p>FX5-1PSU-5V</p>

Bus Conversion Module



Bus Conversion Module

FX5-CNV-BUS

FX3 Expansion Modules

Extension Power Supply Module	Intelligent Function Modules																												
 <p>Extension Power Supply Module</p> <p>FX3U-1PSU-5V</p>	<table border="1"> <thead> <tr> <th colspan="2">Analog</th> <th colspan="2">Temperature control</th> </tr> </thead> <tbody> <tr> <td>FX3U-4AD</td> <td>For input</td> <td>FX3U-4LC</td> <td>Temperature control</td> </tr> <tr> <td>FX3U-4DA</td> <td>For output</td> <td colspan="2">High Speed counter</td> </tr> <tr> <td colspan="2">Positioning</td> <td>FX3U-2HC</td> <td>For high-speed input</td> </tr> <tr> <td>FX3U-1PG</td> <td>For high-speed output</td> <td colspan="2">Network</td> </tr> <tr> <td>FX3U-64CCL</td> <td>CC-Link slave</td> <td colspan="2"></td> </tr> <tr> <td>FX3U-16CCL-M</td> <td>CC-Link master</td> <td colspan="2"></td> </tr> </tbody> </table> <p>The parameters for FX3U intelligent function module must be set by PLC program. When connecting FX3 expansion module, FX3 speed is applied as the bus speed for accessing the FX3 expansion module.</p>	Analog		Temperature control		FX3U-4AD	For input	FX3U-4LC	Temperature control	FX3U-4DA	For output	High Speed counter		Positioning		FX3U-2HC	For high-speed input	FX3U-1PG	For high-speed output	Network		FX3U-64CCL	CC-Link slave			FX3U-16CCL-M	CC-Link master		
Analog		Temperature control																											
FX3U-4AD	For input	FX3U-4LC	Temperature control																										
FX3U-4DA	For output	High Speed counter																											
Positioning		FX3U-2HC	For high-speed input																										
FX3U-1PG	For high-speed output	Network																											
FX3U-64CCL	CC-Link slave																												
FX3U-16CCL-M	CC-Link master																												

FX5UC

**Max. 6
Expansion Adapters**

**Max. 16*
Expansion Modules**

Compact body packed with diverse functions.

Compact expansion module contributes to system downsizing!

The expansion module compatible with FX5UC is compact and easy-to-use, and helps to downsize your system.

Easily connect to the FX5 and FX3 expansion modules with the variety of conversion modules available.

*: Due to power limitations, only 12 modules can be directly connected to the CPU module. Up to 16 modules can be connected using the power supply module (future support). Excluding connector conversion module

FX5 Expansion Adapters



Max.
2 ch

Communication

FX5-232ADP For RS-232C communication
FX5-485ADP For RS-485 communication



Max.
4 ch

Analog

FX5-4AD-ADP For input
FX5-4DA-ADP For output

FX5UC CPU Modules

Sink type



FX5UC-32MT/D

DC
D1
T1

Source type



FX5UC-32MT/DSS

DC
D2
T2

FX5 Expansion Modules (connector type)

I/O Modules

Sink type



FX5-C32EX/D For input expansion
FX5-C32EY/D For output expansion
FX5-C32ET/D For I/O expansion



Source type



FX5-C32EX/DSS For input expansion
FX5-C32EY/DSS For output expansion
FX5-C32ET/DSS For I/O expansion

DC DC power supply
D1 DC input (sink) D2 DC input (sink/source)
T1 Transistor output (sink) T2 Transistor output (source)







Option

<p>Battery</p> <p>FX3U-32BL</p>	<p>SD card</p> <p>NZ1MEM-2GBSD (2 GB) NZ1MEM-4GBSD (4 GB)</p>		<p style="background-color: #0056b3; color: white; padding: 2px;">Terminal block for sink type I/O</p> <p>FX-16E-TB FX-16EYT-TB FX-16EYR-TB FX-16EX-A1-TB FX-16EYS-TB FX-32E-TB</p>
<p>Programming software</p> <p>GX Works3</p>	<p style="background-color: #800080; color: white; padding: 2px;">Terminal block for source type I/O</p> <p>FX-16E-TB/UL FX-16EYT-ES-TB/UL FX-16EYR-ES-TB/UL FX-16EYT-ESS-TB/UL FX-16EYS-ES-TB/UL FX-32E-TB/UL</p>		
<p>I/O cable</p>			
	<ul style="list-style-type: none"> General-purpose I/O cable FX-16E-500CAB-S (5 m, 20-pin) For terminal block FX-16E-[]CAB (double-end 20-pin) []: 150 (1.5 m)/300 (3 m)/500 (5 m) 	<ul style="list-style-type: none"> For terminal block FX-16E-[]CAB-R (20-pin) []: 150 (1.5 m)/300 (3 m)/500 (5 m) 	

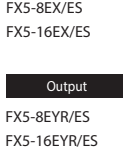

Generic Specifications

Item	Generic specifications	
Power supply, Input/output	Power supply specifications	24 V DC
	Power consumption	8 W (32M)
	Rush current	Max. 30 A 0.5 ms or less/24 V DC
	5 V DC power supply capacity	720 mA or less (32M)
	24 V DC power supply capacity	500 mA or less (32M)
	Input specifications	24 V DC, 5.3 mA
	Output specifications	Transistor output type: Y000 to Y003 0.3 A/1 point, Y004 and higher 0.1 A/1 point, 0.8 A/8 points common 5 to 30 V DC
	Input/output expansion	Expansion device for FX5UC and FX5 (connector adapter required) can be connected
Built-in communication port	Ethernet (100BASE-TX/10BASE-T), RS-485 (MELSOFT connection, MC protocol, non-protocol communication, MODBUS RTU, inverter communication, N:N communication)	
Built-in memory card slot	1 slot for SD memory card	

FX5 Expansion Modules (terminal block type)

Connector Conversion Module	I/O Modules	Output Modules	Intelligent Function Modules
 <p>Connector Conversion Module FX5-CNV-IFC</p>	 <p>Input FX5-8EX/ES FX5-16EX/ES</p>  <p>Output FX5-8EYR/ES FX5-16EYR/ES</p>	<p>Sink type</p>  <p>Output FX5-8EYT/ES FX5-16EYT/ES</p> <p>Source type</p>  <p>Output FX5-8EYT/ESS FX5-16EYT/ESS</p>	 <p>Simple Motion FX5-40SSC-S</p>  <p>Network CC-Link/IE Field slave ... Future support</p>

Bus Conversion Modules

 <p>Bus Conversion Module FX5-CNV-BUS</p>
 <p>Bus Conversion Module FX5-CNV-BUSC</p>

FX3 Expansion Modules

Intelligent Function Modules	
<p>Analog</p> <p>FX3U-4AD For input FX3U-4DA For output</p> <p>Positioning</p> <p>FX3U-1PG For high-speed output</p> <p>Network</p> <p>FX3U-64CCL CC-Link slave FX3U-16CCL-M CC-Link master</p>	<p>Temperature control</p> <p>FX3U-4LC Temperature control</p> <p>High Speed counter</p> <p>FX3U-2HC For high-speed input</p>

The parameters for FX3U intelligent function module must be set by PLC program.
When connecting FX3 expansion module, FX3 speed is applied as the bus speed for accessing the FX3 expansion module.

Selecting the FX5U Model

Product configuration



FX5U

- Control scale: 32 to 256 points (CPU module: 32/64/80 points)
- Control points up to 512 input/output points, including remote input/output*

* : CC-Link

Type	Details	Connection details, model selection
1 CPU module	PLC with built-in CPU, power supply, input/output and program memory.	Various expansion devices can be connected.
2 4 I/O module	Product for expanding I/O. Some products are powered.	Input/output can be expanded to up to 256 points. (Expansion module: Max. 16 modules (excluding extension power supply module)). The total with CC-Link remote input/output is max. 512 points.
3 FX5 extension power supply module	Module for expanding power supply if CPU module's internal power supply is insufficient. Extension cable is enclosed.	Power can be supplied to I/O module, intelligent function module, and bus conversion module. Up to 2 modules can be connected.
5 FX5 intelligent function module	Module with functions other than input/output.	Up to 16 expansion modules including the I/O module can be connected (excluding the extension power supply module).
6 Bus conversion module	Conversion module for connecting FX3 Series expansion module.	FX3 Series expansion module can be connected only to the right side of the bus conversion module.
7 FX5 expansion board	Board connected to front of CPU module to expand functions.	Up to 1 module can be connected to the front of the CPU module. (Expansion adapter can also be used.)
8 FX5 expansion adapter	Adapter connected to left side of CPU module to expand functions.	Up to 6 modules can be connected to the left side of the CPU module.
9 FX3 extension power supply module	Module for expanding power supply if CPU module's internal power supply is insufficient.	The bus conversion module is required for use. Up to 2 modules can be connected.
10 FX3 intelligent function module	Module with functions other than input/output.	The bus conversion module is required for use. When using the FX3 extension power supply module, up to 8 modules* can be used. When not using the FX3 extension power supply unit, up to 6 modules* can be used.

* : Excluding some models

1 CPU module

Type	Function	Number of occupied input/output points	Power supply capacity		I/O type	No. of input points	No. of output points
			5 V DC power supply	24 V DC service power supply			
FX5U-32MR/ES	CPU module (service power built-in)	32 points	900 mA	400 mA (480 mA*)	DC input (sink/source)/relay output	16 points	16 points
FX5U-32MT/ES					DC input (sink/source)/transistor (sink)		
FX5U-32MT/ESS					DC input (sink/source)/transistor (source)		
FX5U-64MR/ES		64 points	1100 mA	600 mA (740 mA*)	DC input (sink/source)/relay output	32 points	32 points
FX5U-64MT/ES					DC input (sink/source)/transistor (sink)		
FX5U-64MT/ESS					DC input (sink/source)/transistor (source)		
FX5U-80MR/ES		80 points	1100 mA	600 mA (770 mA*)	DC input (sink/source)/relay output	40 points	40 points
FX5U-80MT/ES					DC input (sink/source)/transistor (sink)		
FX5U-80MT/ESS					DC input (sink/source)/transistor (source)		

* : Power supply capacity when using external power supply for input circuit.

2 I/O module

Type	Function	Number of occupied input/output points	Power supply capacity		I/O type	No. of input points	No. of output points
			5 V DC power supply	24 V DC service power supply			
FX5-32ER/ES	Input/output module (service power built-in)	32 points	965 mA	250 mA (310 mA*)	DC input(sink/source)/relay output	16 points	16 points
FX5-32ET/ES					DC input (sink/source)/transistor (sink)		
FX5-32ET/ESS					DC input (sink/source)/transistor (source)		

* : Power supply capacity when using external power supply for input circuit.

3 FX5 extension power supply module

Type	Function	Number of occupied input/output points	Power supply capacity	
			5 V DC power supply	24 V DC power supply
FX5-1PSU-5V	Extension power supply	—	1200 mA*	300 mA*

* : Refer to the manual if the ambient temperature exceeds 40°C.

4 I/O module

Type	I/O format	Number of occupied input/output points	Current consumption		
			5 V DC internal current consumption	24 V DC internal current consumption	24 V DC external electric supply
FX5-8EX/ES	DC input (sink/source)	8 points	75 mA	50 mA	—
FX5-16EX/ES	DC input (sink/source)	16 points	100 mA	85 mA	
FX5-8EYR/ES	Relay output	8 points	75 mA	75 mA	
FX5-8EYT/ES	Transistor output (sink)				
FX5-8EYT/ESS	Transistor output (source)	16 points	100 mA	125 mA	
FX5-16EYR/ES	Relay output				
FX5-16EYT/ES	Transistor output (sink)				
FX5-16EYT/ESS	Transistor output (source)				

5 FX5 intelligent function module

Type	Function	Number of occupied input/output points	Current consumption		
			5 V DC internal current consumption	24 V DC internal current consumption	24 V DC external electric supply
FX5-40SSC-S	Simple Motion 4-axis control (SSCNET III/H compatible)	8 points	—	—	250 mA

6 Bus conversion module

Type	Function	Number of occupied input/output points	Current consumption		
			5 V DC internal current consumption	24 V DC internal current consumption	24 V DC external electric supply
FX5-CNV-BUS	Bus conversion FX5→FX3	8 points	150 mA	—	—

7 FX5 Expansion board

Type	Function	Number of occupied input/output points	Current consumption		
			5 V DC internal current consumption	24 V DC internal current consumption	24 V DC external electric supply
FX5-232-BD	RS-232C communication	—	20 mA	—	—
FX5-485-BD	RS-485 communication				
FX5-422-BD-GOT	RS-422 communication (for GOT connection)				

*: The current consumption will increase when the 5 V type GOT is connected.

8 FX5 Expansion adapter

Type	Function	Number of occupied input/output points	Current consumption		
			5 V DC internal current consumption	24 V DC internal current consumption	24 V DC external electric supply
FX5-232ADP	RS-232C communication	—	30 mA	30 mA	—
FX5-485ADP	RS-485 communication		20 mA		
FX5-4AD-ADP	4 ch voltage input/current input		10 mA	20 mA	
FX5-4DA-ADP	4 ch voltage output/current output			—	

9 FX3 extension power supply module

Type	Function	Number of occupied input/output points	Current consumption		
			5 V DC internal current consumption	24 V DC internal current consumption	24 V DC external electric supply
FX3U-1PSU-5V	Extension power supply	—	1000 mA*	300 mA*	—

*: Refer to the manual if the ambient temperature exceeds 40°C.

10 FX3 intelligent function module

Type	Function	Number of occupied input/output points	Current consumption		
			5 V DC internal current consumption	24 V DC internal current consumption	24 V DC external electric supply
FX3U-4AD	4 ch voltage input/current input	8 points	110 mA	—	90 mA
FX3U-4DA	4 ch voltage output/current output		120 mA		160 mA
FX3U-4LC	4-loop temperature control (thermocouple, PT and mini voltage)	*	160 mA	—	50 mA
FX3U-16CCL-M	CC-Link Master (Ver. 2.00 and Ver. 1.10 compatible)		—		240 mA
FX3U-64CCL	CC-Link intelligent device station	8 points	150 mA	—	220 mA
FX3U-1PG	Pulse output for independent 1-axis control				40 mA
FX3U-2HC	2 ch high-speed counter				245 mA

*: Varies according to settings.

Calculation of current consumed by expansion modules

The power required for the expansion adapter, expansion board and expansion module is supplied from the CPU module or extension power supply module. Use the following calculations to confirm whether the required power can be supplied. (All calculations must be satisfied.)

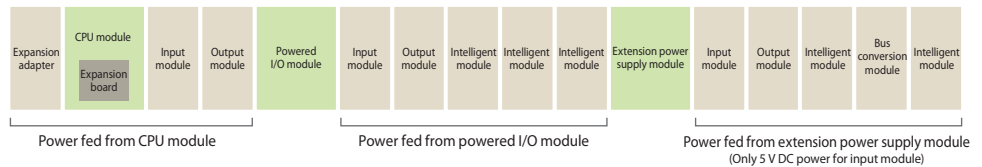

Power fed from CPU module [5 V DC power supply]

$$5\text{ V DC power supply capacity (CPU module)} - \text{Total current consumption (total of connected expansion devices)} = \text{Calculation results} \geq 0\text{ mA}$$

[24 V DC power supply]

$$24\text{ V DC service power supply capacity (CPU module)} - \text{Total current consumption (total of connected expansion devices)} = \text{Calculation results} \geq 0\text{ mA}^*$$

Power fed from powered I/O module [5 V DC power supply]

$$5\text{ V DC power supply capacity (powered I/O module)} - \text{Total current consumption (total of connected expansion devices)} = \text{Calculation results} \geq 0\text{ mA}$$

[24 V DC power supply]

$$24\text{ V DC service power supply capacity (powered I/O module)} - \text{Total current consumption (total of connected expansion devices)} = \text{Calculation results} \geq 0\text{ mA}^*$$

Power fed from extension power supply module [5 V DC power supply]

(Separate calculations are required when using the FX3 Series extension power supply module.)

$$5\text{ V DC power supply capacity (Extension power supply module)} - \text{Total current consumption (total of connected expansion devices)} = \text{Calculation results} \geq 0\text{ mA}$$

[24 V DC power supply]

$$24\text{ V DC service power supply capacity (Extension power supply module)} - \text{Total current consumption (total of connected expansion devices)} = \text{Calculation results} \geq 0\text{ mA}^*$$

<Caution> If the calculation results are negative, the power capacity is exceeded so review the system configuration.

*: The 24 V DC service power calculation results value (when positive) indicate the 24 V DC service power supply's remaining capacity, and can be used as an external load power.

The number of connected modules may be limited for some products. Refer to page 20 for details.

Rules of System Configuration

The FX5U CPU module can control a total of 512 points including the CPU module and expansion device input/output points and remote input/output points.

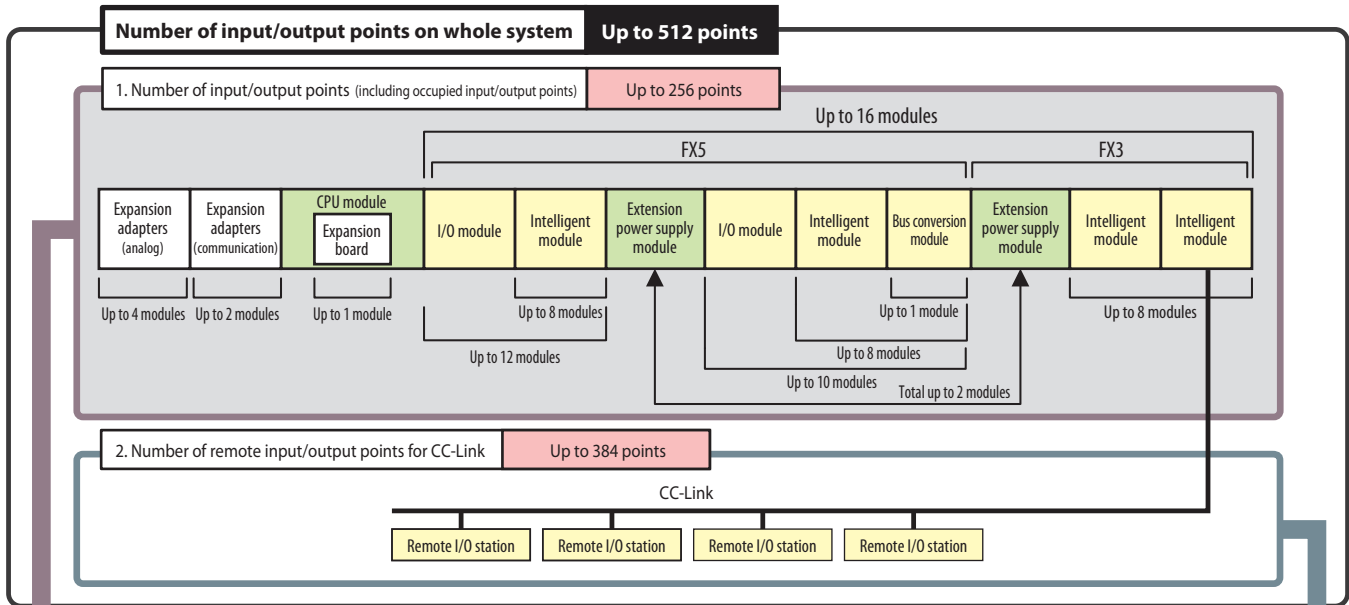

Number of I/O points

The maximum number of input/output points that can be configured with the FX5U is shown below.

Maximum number of input/output points

256 points

≥

Number of occupied input/output points

CPU module

I/O module

Intelligent module

(A) points

+

Total (B) points

+

(C) modules

× 8 points

Expansion adapter, expansion board and extension power supply module do not occupy any input/output.

(A): Number of CPU module input/output points (B): Total number of I/O module input/output points (C): Total number of intelligent modules

Number of input/output points when using network master module

The maximum number of input/output points when using the network master module is shown below.

Maximum number of input/output points

384 points

≥

Number of occupied remote input/output points

CC-Link

(D) station

× 32 points

CC-Link is the total of the number of remote I/O stations × 32 points. (Calculated as 32 points regardless of the number of remote I/O points.)

(D): Number of CC-Link remote I/O stations

Total 512 points or less

Limitation on number of modules when expanding

The number of connectable modules is limited for the following products. Refer to the manual for details.

Type	Model/type	Setting method/precautions
Intelligent function module for FX3 Series	FX3U-4AD	<ul style="list-style-type: none"> When using FX3U extension power supply module: Up to 8 modules can be connected per system When not using FX3U extension power supply module: Up to 6 modules can be connected per system.
	FX3U-4DA	
	FX3U-1PG	
	FX3U-4LC	
	FX3U-16CCL-M	
	FX3U-64CCL	
	FX3U-2HC	Up to 1 module can be connected for the entire system.
		Up to 2 modules can be connected for the entire system. When not using the FX3U-1PSU-5V, connect immediately after the bus conversion module.

Refer to the manual for details on each device.

Selecting the FX5UC Model

Product configuration



FX5UC

- Control scale: 32 to 256 points (CPU module: 32 points)
- Control points up to 512 input/output points, including remote input/output*

*: CC-Link



Type	Details	Connection details, model selection
1 CPU module	PLC with built-in CPU, power supply, input/output and program memory.	Various expansion devices can be connected.
2 I/O module (connector type)	Connector type product for expanding the input/output.	The input/output can be expanded to up to 256 points. (Expansion module: Max. 12 modules (excluding connector conversion module)). The total with CC-Link remote input/output is max. 512 points.
3 Connector conversion module	Converts the connector for connecting the FX5 Series expansion devices.	Expansion devices for the FX5 Series can be connected.
4 I/O module (terminal block type)	Product for expanding the input/output.	The input/output can be expanded to up to 256 points. (Expansion module: Max. 12 modules (excluding connector conversion module)). The total with CC-Link remote input/output is max. 512 points.
5 FX5 intelligent function module	Module with functions other than input/output.	Up to 12 expansion modules including the I/O module can be connected (excluding the connector conversion module).
6 Bus conversion module	Conversion module for connecting FX3 Series expansion module.	The FX3 Series expansion module can be connected only to the right side of the bus conversion module.
7 FX5 expansion adapter	Adapter connected to left side of CPU module to expand functions.	Up to 6 modules can be connected to the left side of the CPU module.
8 FX3 intelligent function module	Module with functions other than input/output.	A bus conversion module is required for use. Up to 6 bus conversion modules* can be connected on the right side.

*: Excluding some models

1 CPU module

Type	Function	Number of occupied input/output points	Power supply capacity		I/O type	No. of input points	No. of output points
			5 V DC power supply	24 V DC service power supply			
FX5UC-32MT/D	CPU module	32 points	720 mA	500 mA	DC input (sink)/transistor (sink)	16 points	16 points
FX5UC-32MT/DSS					DC input (sink/source)/transistor (source)		

2 I/O module(connector type)

Type	I/O format	Number of occupied input/output points	Current consumption		
			5 V DC internal current consumption	24 V DC internal current consumption	24 V DC external electric supply
FX5-C32EX/D	DC input (sink)	32 points	120 mA	200 mA	—
FX5-C32EX/DS	DC input (sink/source)				
FX5-C32EYT/D	Transistor output (sink)				
FX5-C32EYT/DSS	Transistor output (source)				
FX5-C32ET/D	DC input (sink)/Transistor output (sink)				
FX5-C32ET/DSS	DC input (sink/source)/Transistor output (source)				

3 Connector conversion module

Type	Function	Number of occupied input/output points	Current consumption		
			5 V DC internal current consumption	24 V DC internal current consumption	24 V DC external electric supply
FX5-CNV-IFC	Connector conversion	—	—	—	—

4 I/O module (terminal block type)

Type	Function	Number of occupied input/output points	Current consumption		
			5 V DC internal current consumption	24 V DC internal current consumption	24 V DC external electric supply
FX5-8EX/ES	DC input (sink/source)	8 points	75 mA	50 mA*	—
FX5-16EX/ES	DC input (sink/source)	16 points	100 mA	85 mA*	
FX5-8EYR/ES	Relay output	8 points	75 mA	75 mA	
FX5-8EYT/ES	Transistor output (sink)				
FX5-8EYT/ESS	Transistor output (source)	16 points	100 mA	125 mA	
FX5-16EYR/ES	Relay output				
FX5-16EYT/ES	Transistor output (sink)				
FX5-16EYT/ESS	Transistor output (source)				

* : Since external power supply is used for input circuit in FX5UC CPU module systems, power supply from CPU module is not included.

5 FX5 intelligent function module

Type	Function	Number of occupied input/output points	Current consumption		
			5 V DC internal current consumption	24 V DC internal current consumption	24 V DC external electric supply
FX5-40SSC-S	Simple Motion 4-axis control (SSCNET III/H compatible)	8 points	—	—	250 mA

6 Bus conversion module

Type	Function	Number of occupied input/output points	Current consumption		
			5 V DC internal current consumption	24 V DC internal current consumption	24 V DC external electric supply
FX5-CNV-BUSC	Bus conversion (connector)FX5→FX3	8 points	150 mA	—	—
FX5-CNV-BUS	Bus conversion FX5→FX3				

7 FX5 Expansion adapter

Type	Function	Number of occupied input/output points	Current consumption		
			5 V DC internal current consumption	24 V DC internal current consumption	24 V DC external electric supply
FX5-232ADP	RS-232C communication	—	30 mA	30 mA	—
FX5-485ADP	RS-485 communication		20 mA		
FX5-4AD-ADP	4 ch voltage input/current input		10 mA	20 mA	
FX5-4DA-ADP	4 ch voltage output/current output			—	

8 FX3 intelligent function module

Type	Function	Number of occupied input/output points	Current consumption			
			5 V DC internal current consumption	24 V DC internal current consumption	24 V DC external electric supply	
FX3U-4AD	4 ch voltage input/current input	8 points	110 mA	—	90 mA	
FX3U-4DA	4 ch voltage output/current output		120 mA		160 mA	
FX3U-4LC	4-loop temperature control (thermocouple, PT and mini voltage)		160 mA		50 mA	
FX3U-16CCL-M	CC-Link Master (Ver. 2.00 and Ver. 1.10 compatible)	*	—		240 mA	
FX3U-64CCL	CC-Link intelligent device station	8 points	150 mA		—	220 mA
FX3U-1PG	Pulse output for independent 1-axis control					40 mA
FX3U-2HC	2 ch high-speed counter			245 mA		—

* : Varies according to settings.

Calculation of current consumed by expansion modules

The power required for the expansion adapter and expansion module is supplied from the CPU module. Use the following calculations to confirm whether the required power can be supplied. (All calculations must be satisfied.)

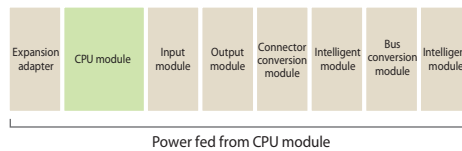

Power fed from CPU module [5 VDC power supply]

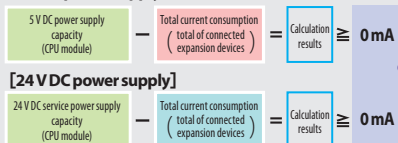

<Caution> If the calculation results are negative, the power capacity is exceeded so review the system configuration.

The number of connected modules may be limited for some products. Refer to page 20 for details.

Rules of System Configuration

The FX5UC CPU module can control a total of 512 points including the CPU module and expansion device input/output points and remote input/output points.

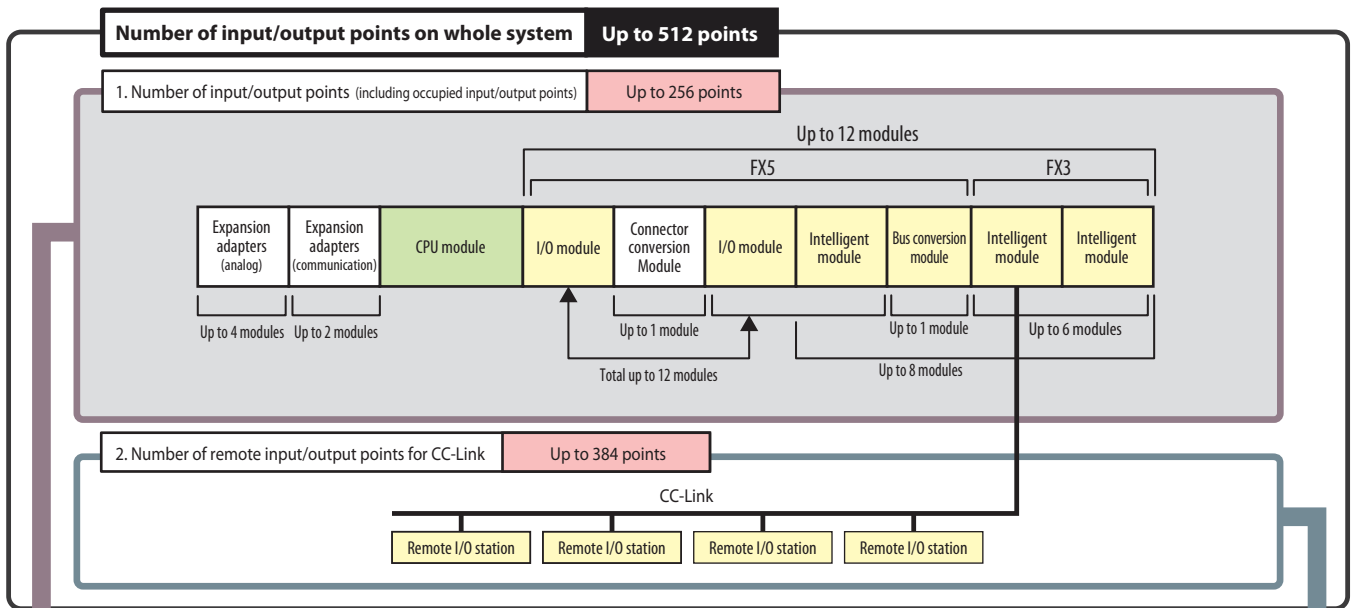

Number of I/O points

The maximum number of input/output points that can be configured with the FX5UC is shown below.

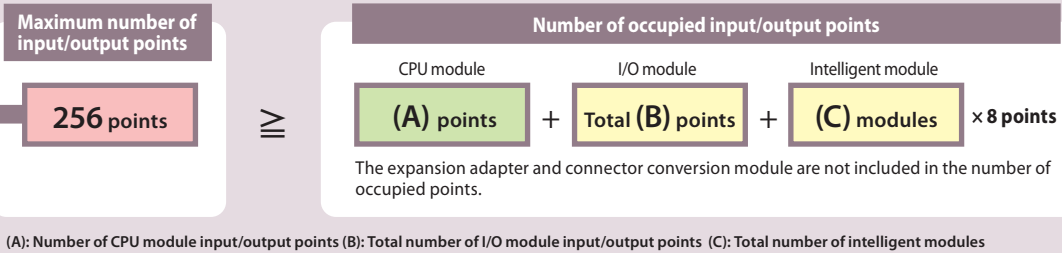

Total 512 points or less

Number of input/output points when using network master module

The maximum number of input/output points when using the network master module is shown below.

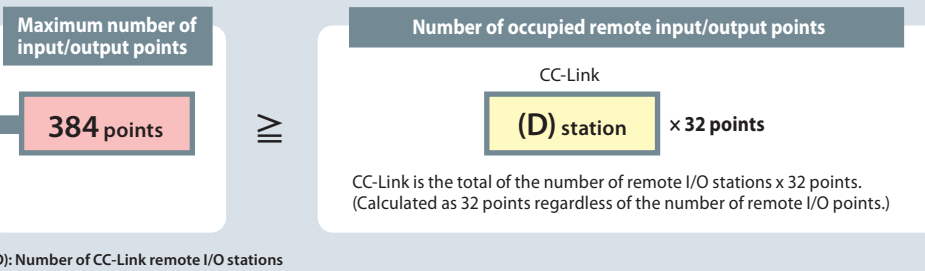

Limitation on number of modules when expanding

The number of connectable modules is limited for the following products. Refer to the manual for details.

Type	Model/type	Setting method/precautions
Intelligent function module for FX3 Series	FX3U-4AD	Up to 6 modules can be connected for the entire system.
	FX3U-4DA	
	FX3U-1PG	
	FX3U-4LC	Up to 1 module can be connected for the entire system.
	FX3U-16CCL-M	
	FX3U-64CCL	
	FX3U-2HC	Up to 2 modules can be connected for the entire system. Connect immediately after the bus conversion module.

Refer to the manual for details on each device.

Product specifications

CPU module specification

Generic Specifications

Item	Specifications				
	FX5U			FX5UC	
Operating ambient temperature ^{*1}	0 to 55°C (32 to 131°F) ^{*2}				
Storage ambient temperature	-25 to 75°C (-13 to 167°F)				
Operating ambient humidity	5 to 95%RH, non-condensation				
Storage ambient humidity	5 to 95%RH, non-condensation				
Vibration resistance ^{*3,*4}		Frequency	Acceleration	Half amplitude	Sweep count
	Installed on DIN rail	5 to 8.4 Hz	—	1.75 mm	10 times each in X, Y, Z directions (80 min in each direction)
		8.4 to 150 Hz	4.9 m/s ²	—	
	Direct installing	5 to 8.4 Hz	—	3.5 mm	
8.4 to 150 Hz		9.8 m/s ²	—		
Shock resistance ^{*5}	147 m/s ² , Action time: 11 ms, 3 times by half-sine pulse in each direction X, Y, and Z				
Grounding	Class D grounding (grounding resistance: 100 Ω or less) <Common grounding with a heavy electrical system is not allowed.> ^{*5}				
Working atmosphere	Free from corrosive or flammable gas and excessive conductive dust				
Operating altitude ^{*6}	0 to 2000 m				
Installation location	Inside a control panel				
Overvoltage category ^{*7}	II or less				
Pollution degree ^{*8}	2 or less				
Equipment class	Class 2				

* 1: The simultaneous ON ratio of available PLC inputs or outputs changes with respect to the ambient temperature, refer to manuals of each product.

* 2: For details on Intelligent function modules, refer to manuals of each product.

* 3: The criterion is shown in IEC61131-2.

* 4: When the system has equipment which specification values are lower than above mentioned vibration resistance specification values, the vibration resistance specification of the whole system is corresponding to the lower specification.

* 5: For grounding, refer to manuals of each product.

* 6: The PLC cannot be used at a pressure higher than the atmospheric pressure to avoid damage.

* 7: This indicates the section of the power supply to which the equipment is assumed to be connected between the public electrical power distribution network and the machinery within premises. Category II applies to equipment for which electrical power is supplied from fixed facilities. The surge voltage withstand level for up to the rated voltage of 300 V is 2500 V.

* 8: This index indicates the degree to which conductive material is generated in the environment in which the equipment is used. Pollution level 2 is when only non-conductive pollution occurs. Temporary conductivity caused by condensation must be expected occasionally.

Power Supply Specifications

Item	Specifications			
	FX5U-32M[]	FX5U-64M[]	FX5U-80M[]	FX5UC-32MT/[]
Rated voltage	100 to 240 V AC			24 V DC
Allowable supply voltage range	85 to 264 V AC			20.4 to 28.8 V DC
Frequency rating	50/60 Hz			—
Allowable instantaneous power failure time	Operation can be continued upon occurrence of instantaneous power failure for 10 ms or less.			Operation can be continued upon occurrence of instantaneous power failure for 5 ms or less.
Power fuse	250 V, 3.15 A Time-lag fuse		250 V, 5 A Time-lag fuse	125 V, 3.15 A Time-lag fuse
Rush current	25 A max. 5 ms or less/100 V AC 50 A max. 5 ms or less/200 V AC		30 A max. 5 ms or less/100 V AC 60 A max. 5 ms or less/200 V AC	30 A max. 0.5 ms or less/24 V DC
Power consumption ^{*1}	30 W		40 W	45 W
5 V DC power supply capacity ^{*3}	900 mA		1100 mA	1100 mA
24 V DC power supply capacity ^{*2,*3}	Supply capacity when service power supply is used for input circuit of the CPU module	400 mA		600 mA
	Supply capacity when external power supply is used for input circuit of the CPU module	480 mA		770 mA

* 1: This item shows value when all 24 V DC service power supplies are used in the maximum configuration connectable to the CPU module. (The current of the input circuit is included.)

* 2: When I/O modules are connected, they consume current from the 24 V DC service power. For details on the service power supply, refer to manuals of each product.

* 3: Internal power supply in case of FX3UC-32MT/[]

Performance Specifications

Item	Specifications	
	FX5U/FX5UC	
Control system	Stored-program repetitive operation	
Input/output control system	Refresh system (Direct access input/output allowed by specification of direct access input/output [DX, DY])	
Programming specifications	Programming language	Ladder diagram (LD), structured text (ST), function block diagram/ladder diagram (FBD/LD)
	Programming extension function	Function block (FB), structured ladder, label programming (local/global)
	Constant scan	0.2 to 2000 ms (can be set in 0.1 ms increments)
	Fixed cycle interrupt	1 to 60000 ms (can be set in 1 ms increments)
	Timer performance specifications	100 ms, 10 ms, 1 ms
	No. of program executions	32
Operation specifications	No. of FB files	16 (Up to 15 for user)
	Execution type	Standby type, initial execution type, scan execution type, event execution type
	Interrupt type	Internal timer interrupt, input interruption, high-speed comparison match interrupt
Command processing time	LD X0	34 ns
	MOV D0 D1	34 ns
Memory capacity	Program capacity	64 k steps (128 kbytes, flash memory)
	SD memory card	Memory card capacity (SD/SDHC memory card: Max. 4 GB)
	Device/label memory	120 kbytes
	Data memory/standard ROM	5 Mbytes
Flash memory (Flash ROM) write count	Max. 20000 times	
File storage capacity	Device/label memory	1
	Data memory	P: 32, FB: 16
	P: No. of program files/FB: No. of FB files	2 GB: 511 ^{*1} 4 GB: 65534 ^{*1}
Clock function	Display data	Year, month, day, hour, minute, second, day of week (leap year automatic detection)
	Precision	-2.96 to +3.74 (TYP.+1.42) s/d (Ambient temperature: 0°C (32°F)) -3.18 to +3.74 (TYP.+1.50) s/d (Ambient temperature: 25°C (77°F)) -13.20 to +2.12 (TYP.-3.54) s/d (Ambient temperature: 55°C (131°F))
No. of input/output points	(1) No. of input/output points	256 points or less
	(2) No. of remote I/O points	384 points or less
	Total No. of points of (1) and (2)	512 points or less
Power failure retention ^{*2}	Retention method	Large-capacity capacitor
	Retention time	10 days (Ambient temperature: 25°C (77°F))
	Data retained	Clock data

* 1: The value listed above indicates the number of files stored in the root folder.

* 2: Clock data is retained using the power accumulated in a large-capacity capacitor incorporated into the PLC. When voltage of the large-capacity capacitor drops, clock data is no longer accurately retained. The retention period of a fully charged capacitor (electricity is conducted across the PLC for at least 30 minutes) is 10 days (ambient temperature: 25°C (77°F)). How long the capacitor can hold the data depends on the operating ambient temperature. When the operating ambient temperature is high, the holding period is short.

Refer to the manual for details on each device.

□ Number of device points

Item		Base	Max. number of points		
No. of user device points	Input relay (X)	8	1024 points	The total number of X and Y assigned to input/output points is up to 256 points.	
	Output relay (Y)	8	1024 points		
	Internal relay (M)	10	32768 points (can be changed with parameter)*1		
	Latch relay (L)	10	32768 points (can be changed with parameter)*1		
	Link relay (B)	16	32768 points (can be changed with parameter)*1		
	Annunciator (F)	10	32768 points (can be changed with parameter)*1		
	Link special relay (SB)	16	32768 points (can be changed with parameter)*1		
	Step relay (S)	10	4096 points (fixed)		
	Timer system	Timer (T)	10		1024 points (can be changed with parameter)*1
	Accumulation timer system	Accumulation timer (ST)	10		1024 points (can be changed with parameter)*1
	Counter system	Counter (C)	10		1024 points (can be changed with parameter)*1
		Long counter (LC)	10		1024 points (can be changed with parameter)*1
	Data register (D)		10		8000 points (can be changed with parameter)*1
	Link register (W)		16		32768 points (can be changed with parameter)*1
	Link special register (SW)		16		32768 points (can be changed with parameter)*1
No. of system device points	Special relay (SM)	10	10000 points (fixed)		
	Special register (SD)	10	12000 points (fixed)		
Module access device	Intelligent function module device	10	65536 points (designated by U[I]G[I])		
No. of index register points	Index register (Z)*2	10	24 points		
	Long index register (LZ)*2	10	12 points		
No. of file register points	File register (R)	10	32768 points (can be changed with parameter)*1		
No. of nesting points	Nesting (N)	10	15 points (fixed)		
No. of pointer points	Pointer (P)	10	4096 points		
	Interrupt pointer (I)	10	178 points (fixed)		
Others	Decimal constant (K)	Signed	16 bits: -32768 to +32767, 32 bits: -2147483648 to +2147483647		
		Unsigned	16 bits: 0 to 65535, 32 bits: 0 to 4294967295		
	Hexadecimal constant (H)	16 bits: 0 to FFFF, 32 bits: 0 to FFFFFFFF			
	Real constant (E)	Single precision	E-3.40282347+38 to E-1.17549435-38, 0, E1.17549435-38 to E3.40282347+38		
	Character string		Shift-JIS code max. 255 single-byte characters (256 including NULL)		

* 1 : Can be changed with parameters within the capacity range of the CPU built-in memory.

* 2 : Total of the index register (Z) and long index register (LZ) is maximum 24 words.

□ Input Specifications

24 V DC Input (sink/source)

Item	Specifications				
	FX5U-32M[]	FX5U-64M[]	FX5U-80M[]	FX5UC-32MT/D	FX5UC-32MT/DSS
No. of input points	16 points	32 points	40 points	16 points	
Connection type	Removable terminal block (M3 screws)			Connector	
Input type	Sink/source			Sink	Sink/source
Input signal voltage	24 V DC +20 %, -15%				
Input signal current	X000 to X017	5.3 mA/24 V DC		5.3 mA/24 V DC	
	X020 and subsequent	4.0 mA/24 V DC		—	
Input impedance	X000 to X017	4.3 kΩ		4.3 kΩ	
	X020 and subsequent	5.6 kΩ		—	
ON input sensitivity current	X000 to X017	3.5 mA or more		3.5 mA or more	
	X020 and subsequent	3.0 mA or more		—	
OFF input sensitivity current	1.5 mA or less				
Input response frequency	X000 to X005	200 kHz		200 kHz	
	X006 to X007	10 kHz		10 kHz	
	X010 to X017	—		10 kHz	
Pulse waveform	Waveform				
	X000 to X005	T1: 2.5 μs or more, T2: 1.25 μs or less		T1: 2.5 μs or more, T2: 1.25 μs or less	
	X006 to X007	T1: 50 μs or more, T2: 25 μs or less		T1: 50 μs or more, T2: 25 μs or less	
	X010 to X017	—		—	
Input response time (H/W filter delay)	X000 to X005	ON: 2.5 μs or less, OFF: 2.5 μs or less		ON: 2.5 μs or less, OFF: 2.5 μs or less	
	X006 to X007	ON: 30 μs or less, OFF: 50 μs or less		ON: 30 μs or less, OFF: 50 μs or less	
	X010 to X017	—		—	
Input response time (Digital filter setting value)	None, 10 μs, 50 μs, 0.1 ms, 0.2 ms, 0.4 ms, 0.6 ms, 1 ms, 5 ms, 10 ms (initial values), 20 ms, 70 ms When using this product in an environment with much noise, set the digital filter.				
Input signal format	No-voltage contact input Sink: NPN open collector transistor Source: PNP open collector transistor			No-voltage contact input NPN open collector transistor Sink: NPN open collector transistor Source: PNP open collector transistor	
Input circuit insulation	Photo-coupler insulation				
Indication of input operation	LED is lit when input is on			LED is lit when input is on (DISP switch: IN)	
Input circuit configuration	When using service power supply		Sink input wiring		Sink input wiring
	When using external power supply		Sink input wiring		Sink input wiring
		Source input wiring		Source input wiring	

Output Specifications

Relay output

Item	Specifications		
	FX5U-32MR/[]	FX5U-64MR/[]	FX5U-80MR/[]
No. of output points	16 points	32 points	40 points
Connection type	Removable terminal block (M3 screws)		
Output type	Relay		
External power supply	30 V DC or less 240 V AC or less ("250 V AC or less" if not a CE, UL, cUL compliant item)		
Max. load	2 A/point The total load current per common terminal should be the following value. • 4 output points/common terminal: 8 A or less • 8 output points/common terminal: 8 A or less		
Min. load	5 V DC, 2 mA (reference values)		
Open circuit leakage current	—		
Response time	OFF→ON	Approx. 10 ms	
	ON→OFF	Approx. 10 ms	
Insulation of circuit	Mechanical insulation		
Indication of output operation	LED is lit when output is on		
Output circuit configuration	<p>A number is entered in the [] of [COM[]].</p>		

Transistor output

Item	Specifications				
	FX5U-32MT/[]	FX5U-64MT/[]	FX5U-80MT/[]	FX5UC-32MT/D	FX5UC-32MT/DSS
No. of output points	16 points	32 points	40 points	16 points	
Connection type	Removable terminal block (M3 screws)			Connector	
Output type	Transistor/sink output (FX5U-[]MT/ES) Transistor/source output (FX5U-[]MT/ESS)			Transistor/sink output	Transistor/source output
External power supply	5 to 30 V DC				
Max. load	0.5 A/point The total load current per common terminal should be the following value. • 4 output points/common terminal: 0.8 A or less • 8 output points/common terminal: 1.6 A or less			Y000 to Y003: 0.3 A/point Y004 and subsequent: 0.1 A/point The total load current per common terminal should be the following value. • 8 output points/common terminal: 0.8 A or less*	
Open circuit leakage current	0.1 mA or less/30 V DC				
Voltage drop when ON	Y000 to Y003	1.0 V or less			
	Y004 and subsequent	1.5 V or less			
Response time	Y000 to Y003	2.5 μs or less/10 mA or more (5 to 24 V DC)			
	Y004 and subsequent	0.2 ms or less/200 mA or more (24 V DC)			0.2 ms or less/100 mA (24 V DC)
Insulation of circuit	Photo-coupler insulation				
Indication of output operation	LED is lit when output is on				
Output circuit configuration	<p>Sink output wiring</p> <p>Source output wiring</p> <p>A number is entered in the [] of [COM []]. A number is entered in the [] of [+V []].</p>				

* : When 2 common terminals are connected outside the CPU module, resistance load is 1.6 A or less.

Built-in Analog input

Item	Specifications	
	FX5U	
Analog input points	2 points (2 channels)	
Analog input	Voltage	0 to 10 V DC (input resistance 115.7 kΩ)
Digital output	Unsigned 12-bit binary	
I/O characteristics, Maximum resolution	Digital output value	0 to 4000
	Maximum resolution	2.5 mV
Accuracy (Accuracy in respect to maximum digital output value)	Ambient temperature 25 ±5°C (77±41°F)	Within ±0.5% (±20 digit*)
	Ambient temperature 0 to 55°C (32±131°F)	Within ±0.1% (±40 digit*)
Conversion speed	30 μs/channels (data refreshed every operation cycle)	
Absolute maximum input	-0.5 V, +15 V	
Isolation	No isolation between analog input circuit and PLC circuit. No isolation between input terminals (channels).	
Occupied points	0 points (does not pertain to the max. No. of input/output points of the PLC.)	
Terminal block used	European-type terminal block	

* : "Digit" refers to digital values.

Built-in Analog output

Item	Specifications	
	FX5U	
Analog output points	1 points (1 channels)	
Digital input	Unsigned 12-bit binary	
Analog output	Voltage	0 to 10 V DC (external load resistance 2 k to 1 MΩ)
I/O characteristics, Maximum resolution	Digital input value	0 to 4000
	Maximum resolution	2.5 mV
Accuracy (Accuracy in respect to maximum analog output value)	Ambient temperature 25 ±5°C (77±41°F)	Within ±0.5% (±20 digit*)
	Ambient temperature 0 to 55°C (32±131°F)	Within ±0.1% (±40 digit*)
Conversion speed	30 μs (data refreshed every operation cycle)	
Isolation	No isolation between analog output circuit and PLC circuit.	
Occupied points	0 points (does not pertain to the max. No. of input/output points of the PLC.)	
Terminal block used	European-type terminal block	

* : "Digit" refers to digital values.

Built-in RS-485 communication

Item	Specifications	
	FX5U/FX5UC	
Transmission standards	Conforms to RS-485/RS-422 specifications	
Data transmission speed	Max. 115.2 kbps	
Communication method	Full-duplex (FDX) / Half-duplex (HDX)	
Maximum total extension distance	50 m (164' 0")	
Protocol type	MELSOFT connection	
	MELSEC Communication protocol (3C/4C frames)	
	Non-protocol communication	
	MODBUS RTU	
	Inverter communication	
	N:N network	
Insulation method	Not insulated	
Terminal resistors	Built-in (OPEN/110 Ω/330 Ω)	
Terminal block used	European-type terminal block	

Built-in Ethernet communication

Item	Specifications	
	FX5U/FX5UC	
Data transmission speed	100/10 Mbps	
Communication mode	Full-duplex (FDX) / Half-duplex (HDX)	
Interface	RJ45 connector	
Transmission method	Base band	
Maximum segment length (The distance between hub and node)	100 m (328' 1")	
Cascade connection	100BASE-TX	Cascade connection max. 2 stages*1
	10BASE-T	Cascade connection max. 4 stages*1
Protocol type	MELSOFT connection	
	SLMP (3E frame)	
	Socket communication	
	Predefined protocol support	
Number of simultaneously open connections allowed	Total of 8 for socket communication, MELSOFT connection, SLMP, and Predefined protocol support (Up to 8 external devices can access one CPU module at the same time.)	
Insulation method	Pulse transformer insulation	
Cable used*2	For 100BASE-TX connection	Ethernet standard-compatible cable, category 5 or higher (STP cable)
	For 10BASE-T connection	Ethernet standard-compatible cable, category 3 or higher (STP cable)

* 1: Number of stages that can be connected when a repeater hub is used. When a switching hub is used, check the specifications of the switching hub used.
 * 2: A straight cable can be used. If a personal computer or GOT and CPU module are directly connected a cross cable can be used.

Built-in positioning function

Item	Specifications	
	FX5U/FX5UC	
Number of control axes	Independent 4 axes* (Simple linear interpolation by 2-axis simultaneous start)	
Maximum frequency	2147483647 (200 Kpps in pulses)	
Positioning program	Sequence program, Table operation	
Supported CPU units	Transistor output type	
Pulse output	1 instruction (PLSY)	
Positioning	8 instructions (DSZR, DVIT, TBL, PLSV, DRVI, DRVA, DRVTBL, DRVMUL) pulse output	

*: The number of control axes is 2 when the pulse output mode is CW/CCW mode.

Built-in high speed counter function

Item	Specifications	
	FX5U/FX5UC	
Types of high-speed counters	Input specifications	Maximum frequency
	1 phase, 1 input counter (S/W)	200 KHz
	1 phase, 1 input counter (H/W)	200 KHz
	1 phase, 2 input counter	200 KHz
	2 phase, 2 input counter [1 edge count]	200 KHz
	2 phase, 2 input counter [2 edge count]	100 KHz
	2 phase, 2 input counter [4 edge count]	50 KHz
Input allocation	Parameter setup*	
High-speed counter instruction	[High-speed processing instruction] • Setting 32-bit data comparison • Reset 32-bit data comparison • Comparison of 32-bit data band • Start/stop of the 16-bit data high-speed I/O function • Start/stop of the 32-bit data high-speed I/O function [High-speed current value transfer instruction] • High-speed current value transfer of 16-bit data • High-speed current value transfer of 32-bit data	

*: Refer to manuals of each product.

Refer to the manual for details on each device.

Expansion Device Specifications

I/O Modules

Powered input/output modules

Model	Total No. of points	No. of input/output points & Input/output type		Connection type		
		Input	Output			
FX5-32ER/ES	32 points	16 points	24 V DC (Sink/source)	16 points	Relay	Terminal block
FX5-32ET/ES				Transistor (sink)		
FX5-32ET/ESS				Transistor (source)		

Input modules

Model	Total No. of points	No. of input/output points & Input/output type		Connection type		
		Input	Output			
FX5-8EX/ES	8 points	8 points	24 V DC (Sink/source)	—	—	Terminal block
FX5-16EX/ES	16 points	16 points	—	—	—	
FX5-C32EX/D	32 points	32 points	24 V DC (sink)	—	—	Connector
FX5-C32EX/DS			24 V DC (Sink/source)	—	—	

Output modules

Model	Total No. of points	No. of input/output points & Input/output type		Connection type		
		Input	Output			
FX5-8EYR/ES	8 points	—	—	8 points	Relay	Terminal block
FX5-8EYT/ES				Transistor (sink)		
FX5-8EYT/ESS				Transistor (source)		
FX5-16EYR/ES	16 points	—	—	16 points	Relay	Terminal block
FX5-16EYT/ES				Transistor (sink)		
FX5-16EYT/ESS				Transistor (source)		
FX5-C32EYT/D	32 points	—	—	32 points	Transistor (sink)	Connector
FX5-C32EYT/DSS				Transistor (source)		

Input/output modules

Model	Total No. of points	No. of input/output points & Input/output type		Connection type		
		Input	Output			
FX5-C32ET/D	32 points	16 points	24 V DC (sink)	16 points	Transistor (sink)	Connector
FX5-C32ET/DSS			24 V DC (source)	16 points	Transistor (source)	

Expansion adapters

FX5-232ADP

Item	Specifications
Transmission standard/ Maximum transmission distance/ Insulation	Conforming to RS-232C/15 m (49' 2")/Photo-coupler isolation (Between communication line and CPU module)
Connection method	9-pin D-sub, male
Communication method	Half-duplex/Full-duplex
Baud rate	300/600/1200/2400/4800/9600/19200/38400/57600/115200 (bps)
Number of occupied I/O points	0 point (no points occupied)
Applicable CPU module	FX5U, FX5UC PLC
Control power (supplied from CPU module)	5 V DC, 30 mA / 24 V DC, 30 mA

FX5-485ADP

Item	Specifications
Transmission standard/ Maximum transmission distance/ Insulation	Conforming to RS-485, RS-422/1200 m (3937' 0")/Photo-coupler isolation (Between communication line and CPU module)
Connection method	European terminal block
Communication method	Half-duplex/Full-duplex
Baud rate	300/600/1200/2400/4800/9600/19200/38400/57600/115200 (bps)
Terminal resistor	Built-in (OPEN/110 Ω/330 Ω)
Number of occupied I/O points	0 point (no points occupied)
Applicable CPU module	FX5U, FX5UC PLC
Control power (supplied from CPU module)	5 V DC, 20 mA / 24 V DC, 30 mA

FX5-4AD-ADP

Item	Specifications			
Number of analog input points	4 points (4 channels)			
Analog input voltage	-10 to +10 V DC (input resistance 1 MΩ)			
Analog input current	-20 to +20 mA DC (input resistance 250 Ω)			
Digital output value	14-bit binary value			
Input characteristics, resolution*	Analog input range	Digital output value	Resolution	
	Voltage	0 to 10 V	0 to 16000	625 μV
		0 to 5 V	0 to 16000	312.5 μV
		1 to 5 V	0 to 12800	312.5 μV
	Current	-10 to +10V	-8000 to +8000	1250 μV
		0 to 20 mA	0 to 16000	1.25 μA
4 to 20 mA		0 to 12800	1.25 μA	
Accuracy (accuracy for the full scale digital output value)	Ambient temperature 25±5°C: within ±0.1% (±16 digit) Ambient temperature 0 to 55°C: within ±1.0% (±32 digit)			
Absolute maximum input	Voltage: ±15 V, Current: ±30 mA			
Isolation method	Between input terminal and PLC: Photocoupler Between input channels: Non-isolation			
Number of occupied I/O points	0 point (no points occupied)			
Applicable CPU module	FX5U,FX5UC PLC			

*: For the input conversion characteristic, refer to manuals of each product.

FX5-4DA-ADP

Item	Specifications			
Number of analog output points	4 points (4 channels)			
Analog output voltage	-10 to +10 V DC (external load resistance value 1 k to 1 MΩ)			
Analog output current	0 to 20 mA DC (external load resistance value 0 to 500 Ω)			
Digital input	14-bit binary value			
Output characteristics, resolution*	Analog output range	Digital value	Resolution	
	Voltage	0 to 10 V	0 to 16000	625 μV
		0 to 5 V	0 to 16000	312.5 μV
		1 to 5 V	0 to 16000	250 μV
	Current	-10 to +10V	-8000 to +8000	1250 μV
		0 to 20 mA	0 to 16000	1.25 μA
4 to 20 mA		0 to 16000	1 μA	
Accuracy (accuracy for the full scale of the analog output value)	Ambient temperature 25±5°C: ±0.1% (Voltage ±20 mV, Current ±40 μA) Ambient temperature 0 to 55°C: ±0.2% (Voltage ±30 mV, Current ±60 μA)			
Isolation method	Between output terminal and PLC: Photocoupler Between output channels: Non-isolation			
Number of occupied I/O points	0 point (no points occupied)			
Applicable CPU module	FX5U, FX5UC PLC			

*: For the output conversion characteristic, refer to manuals of each product.

Expansion boards

Item	Specifications		
	FX5-232-BD	FX5-485-BD	FX5-422-BD-GOT
Transmission standard	Conforming to RS-232C	Conforming to RS-485, RS-422	Conforming to RS-422
Maximum transmission distance	15 m (49' 2")	50 m (164' 0")	According to the specification of the GOT
Connection method	9-pin D-sub, male	European terminal block	8-pin MINI-DIN, female
Insulation	Not insulated (Between communication line and CPU module)		
Communication method	Half-duplex/Full-duplex	Half-duplex/Full-duplex*	Half-duplex
Baud rate	300/600/1200/2400/4800/9600/19200/38400/57600/115200 (bps)*	300/600/1200/2400/4800/9600/19200/38400/57600/115200 (bps)*	9600/19200/38400/57600/115200 (bps)
Terminal resistor	—	Built-in (OPEN/110 Ω/330 Ω)	—

*: The communication method and baud rate vary depending on the type of communication.

Extension power supply module

FX5-1PSU-5V

Item	Specifications	
Rated Supply voltage	100 to 240 V AC	
All owable supply voltage range	85 to 264 V AC	
Rated frequency	50/60 Hz	
Accuracy (accuracy for the full scale digital output value)	Operation can be continued upon occurrence of instantaneous power failure for 10 ms or less.	
Power fuse	250 V 3.15 A Time-lag Fuse	
In-rush current	25 A Max. 5 ms or less/ 100 V AC 50 A Max. 5 ms or less/ 200 V AC	
Power consumption	20 W Max.	
Output current*	24 V DC	0.3 A (Maximum output current depends on the ambient temperature.)
	5 V DC	1.2 A (Maximum output current depends on the ambient temperature.)

*: For the current conversion characteristic, refer to manuals of each product.

Bus conversion modules

FX5-CNV-BUS (FX5 (terminal block) → FX3 (terminal block) extension)

Item	Specifications
Number of occupied I/O points	8 point
Applicable CPU module	FX5U, FX5UC PLC
Control power (supplied from CPU module)	5 V DC, 150 mA

FX5-CNV-BUSC (FX5 (connector) → FX3 (terminal block) extension)

Item	Specifications
Number of occupied I/O points	8 point
Applicable CPU module	FX5UC PLC
Control power (supplied from CPU module)	5 V DC, 150 mA

Connector conversion module

FX5-CNV-IFC (FX5 (connector) → FX5 (terminal block) extension)

Item	Specifications
Number of occupied I/O points	0 point (does not occupy any I/O points)
Applicable CPU module	FX5U, FX5UC PLC
Control power (supplied from CPU module)	0 mA (no power consumed)

Simple Motion module specification

FX5-40SSC-S

□ Control specification

Item		Specifications
Number of control axes		Up to 4 axes
Operation cycle		1.777 ms
Interpolation function		Linear interpolation (Up to 4 axes), Circular interpolation (2 axes)
Control modes		PTP (Point To Point) control, Trajectory control (both linear and arc), Speed control, Speed-position switching control, Position-speed switching control, Speed-torque control
Acceleration/deceleration process		Trapezoidal acceleration/deceleration, S-curve acceleration/deceleration
Compensation function		Backlash compensation, Electronic gear, Near pass function
Synchronous control	Input axis	Servo input axis, Synchronous encoder axis
	Output axis	Cam axis (Up to 4 axes)
Cam control	Number of registration	Up to 64 (depending on memory capacity, cam resolution and number of coordinates)
	Cam data type	Stroke ratio data type, Coordinate data type
	Cam auto-generation	Cam auto-generation for rotary cutter
Control unit		mm, inch, degree, pulse
Number of positioning data		600 data (positioning data No. 1 to 600)/axis (Can be set with MELSOFT GX Works3 or a sequence program.)
Backup		Parameters, positioning data, and block start data can be saved on flash ROM (battery-less backup)
Home position return	Home position return method	Proximity dog method, Count method 1, Count method 2, Data set method, Scale home position signal detection method
	Fast home position return control	Provided
	Sub functions	Home position return retry, Home position shift
Positioning control	Linear control	1-axis linear control, 2-axis linear interpolation control, 3-axis linear interpolation control, 4-axis linear interpolation control*1 (Composite speed, Reference axis speed)
	Fixed-pitch feed control	1-axis fixed-pitch feed, 2-axis fixed-pitch feed, 3-axis fixed-pitch feed, 4-axis fixed-pitch feed*1
	2-axis circular interpolation	Sub point designation, center point designation
	Speed control	1-axis speed control, 2-axis speed control*1, 3-axis speed control*1, 4-axis speed control*1
	Speed-position switching control	INC mode, ABS mode
	Position-speed switching control	INC mode
	Current value change	Positioning data, Start No. for a current value changing
	NOP instruction	Provided
	JUMP instruction	Unconditional JUMP, Conditional JUMP
	LOOP, LEND	Provided
Manual control	High-level positioning control	Block start, Condition start, Wait start, Simultaneous start, Repeated start
	JOG operation	Provided
	Inching operation	Provided
Expansion control	Manual pulse generator	Possible to connect 1 module (Incremental), Unit magnification (1 to 10000 times)
	Speed-torque control	Speed control without positioning loops, Torque control, Tightening & press-fit control
Absolute position system		Made compatible by setting a battery to servo amplifier
Synchronous encoder interface		Up to 4 channels (Total of the internal interface, via PLC CPU interface, and servo amplifier interface)
Functions that limit control	Internal interface	1 channel (Incremental)
	Speed limit function	Speed limit value, JOG speed limit value
	Torque limit function	Torque limit value, same setting, torque limit value, individual setting
	Forced stop	Valid/Invalid setting
	Software stroke limit function	Movable range check with current feed value, movable range check with machine feed value
Functions that change control details	Hardware stroke limit function	Provided
	Speed change function	Provided
	Override function	1 to 300 [%]
	Acceleration/deceleration time change function	Provided
Other functions	Torque change function	Provided
	Target position change function	Target position address and speed are changeable
	M-code output function	Provided
	Step function	Deceleration unit step, Data No. unit step
Parameter initialization function		Provided
External input signal setting function		Via internal interface, CPU, servo amplifier
Amplifier-less operation function		Provided
Mark detection function		Regular mode, Specified Number of Detections mode, Ring Buffer mode
Mark detection signal	Mark detection signal	Up to 4 points
	Mark detection setting	16 settings
Optional data monitor function		4 points/axis
Driver communication function		Provided
SSCNET connect/disconnect function		Provided
Digital oscilloscope function*2	Bit data	16 ch
	Word data	16 ch

*1: Only reference axis speed can be specified as the interpolation speed designation method.
*2: 8 ch word data and 8 ch bit data can be displayed in real time.

□ Module specification

Item		Specifications	
Servo amplifier connection method		SSCNET III/H	
Maximum overall cable distance [m(ft.)]		400 (1312.32)	
Maximum distance between stations [m(ft.)]		100 (328.08)	
Peripheral I/F		Via CPU module (Ethernet)	
Manual pulse generator operation function		Possible to connect 1 module	
Synchronous encoder operation function		Possible to connect 4 modules (Total of the internal interface, via PLC CPU interface, and servo amplifier interface)	
Input signals (DI)	Number of input points	4 points	
	Input method	Positive common/Negative common shared (Photocoupler isolation)	
	Rated input voltage/current	24 V DC/ Approx. 5 mA	
	Operating voltage range	19.2 to 26.4 V DC (24 V DC +10%/-20%, ripple ratio 5% or less)	
	ON voltage/current	17.5 V DC or more/ 3.5 mA or more	
	OFF voltage/current	7 V DC or less/ 1.0 mA or less	
	Input resistance	Approx. 6.8 kΩ	
	Response time	1 ms or less (OFF→ON, ON→OFF)	
	Recommended wire size	AWG24 - 30 (0.2 - 0.05 mm ²) * AWG24 (0.2 mm ²) recommended	
	Forced stop input signal (EMI)	Number of input points	1 point
Input method		Positive common/Negative common shared (Photocoupler isolation)	
Rated input voltage/current		24 V DC/ Approx. 5 mA	
Operating voltage range		19.2 to 26.4 V DC (24 V DC +10%/-20%, ripple ratio 5% or less)	
ON voltage/current		17.5 V DC or more/ 3.5 mA or more	
OFF voltage/current		7 V DC or less/ 1.0 mA or less	
Input resistance		Approx. 6.8 kΩ	
Response time	4 ms or less (OFF→ON, ON→OFF)		
Recommended wire size	AWG24 - 30 (0.2 - 0.05 mm ²) * AWG24 (0.2 mm ²) recommended		
Signal input form		Phase A/Phase B (magnification by 4/magnification by 2/magnification by 1), PULSE/SIGN	
Manual pulse generator/ Incremental synchronous encoder signal	Differential output type (26LS31 or equivalent)	Input pulse frequency	Up to 1 Mpulse/s (After magnification by 4, up to 4 Mpulse/s)
		Pulse width	1 μs or more
		Leading edge/trailing edge time	0.25 μs or less
		Phase difference	0.25 μs or more
		Rated input voltage	5.5 V DC or less
		High voltage	2.0 to 5.25 V DC
		Low voltage	0 to 0.8 V DC
	Voltage output type Open-collector type (5 V DC)	Differential voltage	±0.2 V
		Cable length	Up to 30 m (98.43 ft.)
		Input pulse frequency	Up to 200 kpulse/s (After magnification by 4, up to 800 kpulse/s)
		Pulse width	5 μs or more
		Leading edge/trailing edge time	1.2 μs or less
		Phase difference	1.2 μs or more
		Rated input voltage	5.5 V DC or less
High voltage	3.0 to 5.25 V DC		
Low voltage	0 to 1.0 V DC		
Cable length	Up to 10m (32.81 ft.)		
Number of occupied I/O points		8 points	
24 V DC internal current consumption		0.25 A	

Refer to the manual for details on each device.

External Dimensions

Unit: mm (inches)

CPU Modules

2-φ4.5-diam mounting holes (FX5U-32M)
 4-φ4.5-diam mounting holes (FX5U-64M, FX5U-80M)
 FX5U-32M does not have the (*)-marked mounting holes.

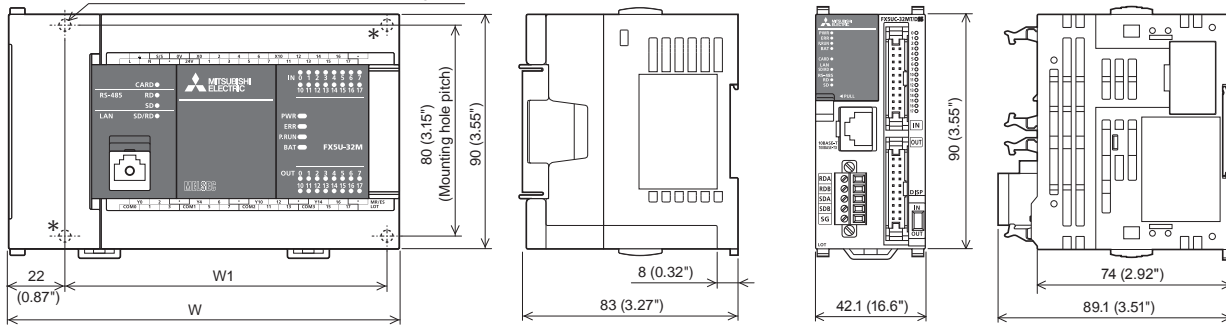

Model name	W: mm (inches)	W1: mm (inches) Mounting hole pitches	MASS (Weight): kg (lbs)
FX5U-32M[]	150 (5.91")	123 (4.85")	Approx. 0.65 (1.43")
FX5U-64M[]	220 (8.67")	193 (7.60")	Approx. 1.0 (2.20")
FX5U-80M[]	285 (11.23")	258 (10.16")	Approx. 1.2 (2.64")

Model name	MASS (Weight): kg (lbs)
FX5UC-32M[]	Approx. 0.2 (0.44")

I/O Modules

FX5 input module/output module (terminal block type)

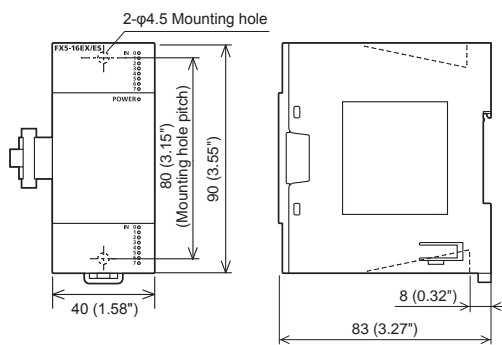

Model name	MASS (Weight): kg (lbs)
FX5-8EX/ES, FX5-8EYR/ES, FX5-8EYT/ES, FX5-8EYT/ESS	Approx. 0.2 (0.44")
FX5-16EX/ES, FX5-16EYR/ES, FX5-16EYT/ES, FX5-16EYT/ESS	Approx. 0.25 (0.55")

FX5 Powered I/O Modules

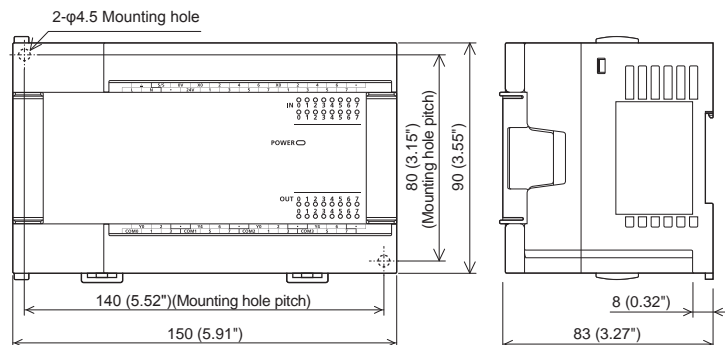

Model name	MASS (Weight): kg (lbs)
FX5-32ER/ES, FX5-32ET/ES, FX5-32ET/ESS	Approx. 0.65 (1.43")

FX5 input module/output module (connector type)

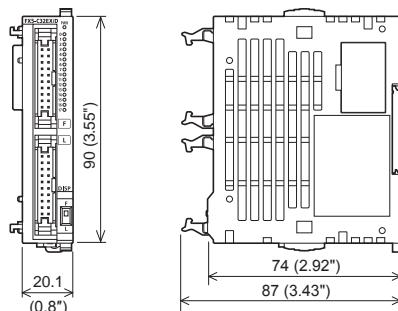

Model name	MASS (Weight): kg (lbs)
FX5-C32EX/D, FX5-C32EX/DS FX5-C32EYT/D, FX5-C32EYT/DSS	Approx. 0.15 (0.33")

FX5 I/O module (connector type)

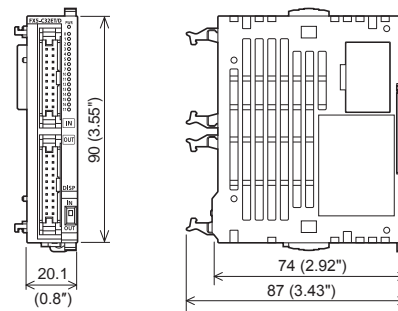

Model name	MASS (Weight): kg (lbs)
FX5-C32ET/D, FX5-C32ET/DSS	Approx. 0.15 (0.33")

Intelligent Function Module

FX5-40SSC-S

MASS (Weight): Approx. 0.3 kg (0.66 lbs)

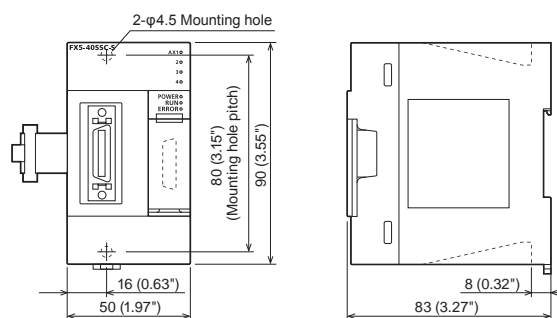

Unit: mm (inches)

Expansion adapters

FX5-4AD-ADP / FX5-4DA-ADP

MASS (Weight): Approx. 0.1 kg (0.22 lbs)

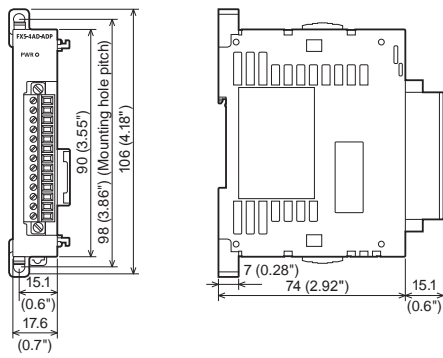

FX5-232ADP / FX5-485ADP

MASS (Weight): Approx. 0.08 kg (0.18 lbs)

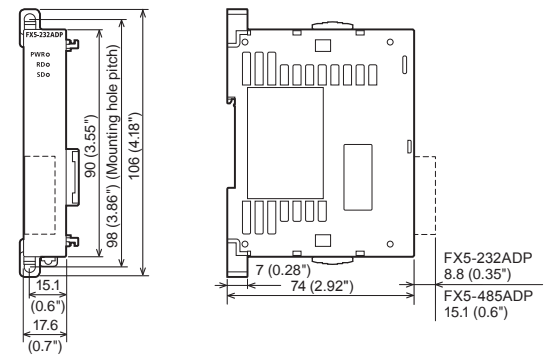

Expansion boards

FX5-232-BD MASS (Weight): Approx. 0.02 kg (0.05 lbs)

FX5-485-BD MASS (Weight): Approx. 0.02 kg (0.05 lbs)

FX5-422-BD-GOT MASS (Weight): Approx. 0.02 kg (0.05 lbs)

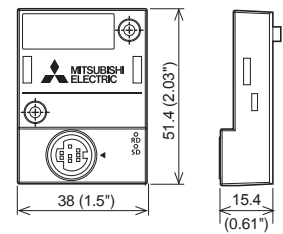
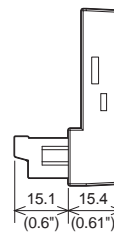
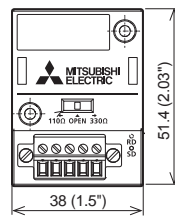
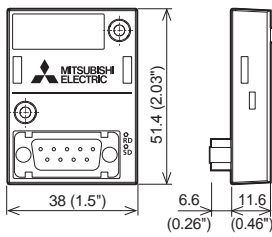

Bus conversion modules

FX5-CNV-BUS

MASS (Weight): Approx. 0.1 kg (0.22 lbs)

FX5-CNV-BUSC

MASS (Weight): Approx. 0.1 kg (0.22 lbs)

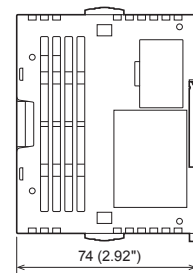
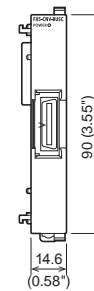
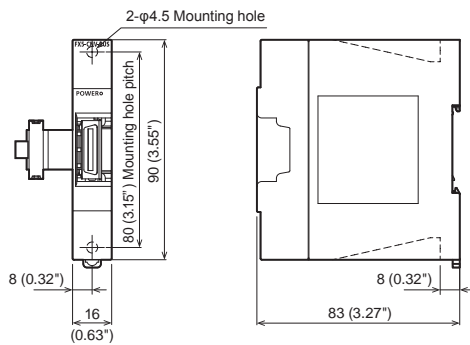

Connector conversion module

FX5-CNV-IFC

MASS (Weight): Approx. 0.06 kg (0.14 lbs)

Extension power supply module

FX5-1PSU-5V

MASS (Weight): Approx. 0.3 kg (0.66 lbs)

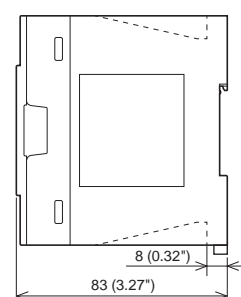
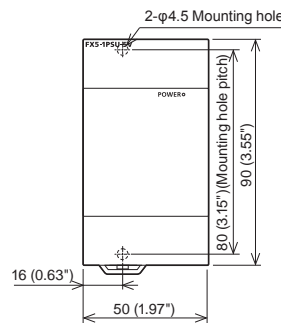
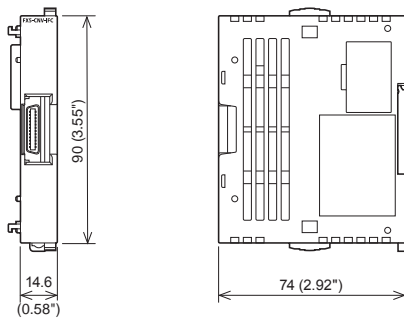

Standards

List of Compatible Products

Model Name	CE		UL	KC	Ship approvals							
	EMC	LVD			cUL	ABS	DNV	LR	GL	BV	RINA	NK
◆ FX5U CPU modules												
FX5U-32MR/ES	○	○	○	○	—	—	—	—	—	—	—	—
FX5U-32MT/ES	○	○	○	○	—	—	—	—	—	—	—	—
FX5U-32MT/ESS	○	○	○	○	—	—	—	—	—	—	—	—
FX5U-64MR/ES	○	○	○	○	—	—	—	—	—	—	—	—
FX5U-64MT/ES	○	○	○	○	—	—	—	—	—	—	—	—
FX5U-64MT/ESS	○	○	○	○	—	—	—	—	—	—	—	—
FX5U-80MR/ES	○	○	○	○	—	—	—	—	—	—	—	—
FX5U-80MT/ES	○	○	○	○	—	—	—	—	—	—	—	—
FX5U-80MT/ESS	○	○	○	○	—	—	—	—	—	—	—	—
◆ FX5UC CPU modules												
FX5UC-32MT/D	○	□	○	○	—	—	—	—	—	—	—	—
FX5UC-32MT/DSS	○	□	○	○	—	—	—	—	—	—	—	—
◆ FX5 I/O modules (terminal block type)												
FX5-8EX/ES	○	□	○	○	—	—	—	—	—	—	—	—
FX5-16EX/ES	○	□	○	○	—	—	—	—	—	—	—	—
FX5-8EYR/ES	○	○	○	○	—	—	—	—	—	—	—	—
FX5-8EYT/ES	○	□	○	○	—	—	—	—	—	—	—	—
FX5-8EYT/ESS	○	□	○	○	—	—	—	—	—	—	—	—
FX5-16EYR/ES	○	○	○	○	—	—	—	—	—	—	—	—
FX5-16EYT/ES	○	□	○	○	—	—	—	—	—	—	—	—
FX5-16EYT/ESS	○	□	○	○	—	—	—	—	—	—	—	—
FX5-32ER/ES	○	○	○	○	—	—	—	—	—	—	—	—
FX5-32ET/ES	○	○	○	○	—	—	—	—	—	—	—	—
FX5-32ET/ESS	○	○	○	○	—	—	—	—	—	—	—	—
◆ FX5 I/O modules (connector type)												
FX5-C32EX/D	○	□	○	○	—	—	—	—	—	—	—	—
FX5-C32EX/DS	○	□	○	○	—	—	—	—	—	—	—	—
FX5-C32EYT/D	○	□	○	○	—	—	—	—	—	—	—	—
FX5-C32EYT/DSS	○	□	○	○	—	—	—	—	—	—	—	—
FX5-C32ET/D	○	□	○	○	—	—	—	—	—	—	—	—
FX5-C32ET/DSS	○	□	○	○	—	—	—	—	—	—	—	—

Model Name	CE		UL	KC	Ship approvals							
	EMC	LVD			cUL	ABS	DNV	LR	GL	BV	RINA	NK
◆ FX5 Intelligent function module												
FX5-40SSC-S	○	□	○	○	—	—	—	—	—	—	—	—
◆ FX5 Extension power supply module												
FX5-1PSU-5V	○	○	○	○	—	—	—	—	—	—	—	—
◆ FX5 Bus conversion modules												
FX5-CNV-BUS	○	□	○	○	—	—	—	—	—	—	—	—
FX5-CNV-BUSC	○	□	○	○	—	—	—	—	—	—	—	—
◆ FX5 Connector conversion module												
FX5-CNV-IFC	○	□	○	○	—	—	—	—	—	—	—	—
◆ FX5 Expansion adapters												
FX5-4AD-ADP	○	□	○	○	—	—	—	—	—	—	—	—
FX5-4DA-ADP	○	□	*	○	—	—	—	—	—	—	—	—
FX5-232ADP	○	□	○	○	—	—	—	—	—	—	—	—
FX5-485ADP	○	□	○	○	—	—	—	—	—	—	—	—
◆ FX5U Expansion boards												
FX5-232-BD	○	□	—	○	—	—	—	—	—	—	—	—
FX5-485-BD	○	□	—	○	—	—	—	—	—	—	—	—
FX5-422-BD-GOT	○	□	—	○	—	—	—	—	—	—	—	—
◆ FX3 Intelligent function modules												
FX3U-4AD	○	□	○	○	—	—	—	—	—	—	—	—
FX3U-4DA	○	□	○	○	—	—	—	—	—	—	—	—
FX3U-4LC	○	□	○	○	—	—	—	—	—	—	—	—
FX3U-1PG	○	□	○	○	—	—	—	—	—	—	—	—
FX3U-2HC	○	□	○	○	—	—	—	—	—	—	—	—
FX3U-16CCL-M	○	□	○	○	—	—	—	—	—	—	—	—
FX3U-64CCL	○	□	○	○	—	—	—	—	—	—	—	—
◆ FX3 Extension power supply module												
FX3U-1PSU-5V	○	○	○	○	—	—	—	—	—	—	—	—

○: Compliant with standards or self-declaration □: No need to comply *: Support planned

■ EN Standards: Compliance with EC Directives/CE marking

EC Directives were issued by the European Council of Ministers to unify standards in the EU Community, and to ensure smooth distribution of products for which safety is ensured. Approximately 20 types of EC Directives for product safety have been issued. Attachment of a CE mark (CE marking) is mandatory on specific products before they may be distributed in the EU. The EMC Directive (Electromagnetic Compatibility Directive) and LVD Directive (Low Voltage Directive) apply to the programmable controller, which is labeled as an electrical part of a machine product under the EC Directives.

1) EMC Directive

The EMC Directive is a directive that requires products to have "Capacity to prevent output of obstructive noise that adversely affects external devices: Emission damage" and "Capacity to not malfunction due to obstructive noise from external source: Immunity".

2) LVD Directive (Low Voltage Directive)

The LVD Directive is enforced to distribute safe products that will not harm or damage people, objects or assets, etc. With the programmable controller, this means a product that does not pose a risk of electric shock, fire or injury, etc.



■ UL/cUL Standards

UL is the United State's main private safety testing and certification agency for ensuring public safety.

UL sets the safety standards for a variety of fields. Strict reviews and testing are performed following the standards set forth by UL. Only products which pass these tests are allowed to carry the UL Mark.

As opposed to the EN Standards, the UL Standards do not have a legally binding effect. However, they are broadly used as the U.S. safety standards, and are an essential condition for selling products into the U.S..

UL is recognized as a certifying and testing agency by the Canadian Standards Association (CSA). Products evaluated and certified by UL in accordance with Canadian standards are permitted to carry the cUL Mark.



Products list

CPU & I/O modules

Model	Specification				
	Power Supply	Input	Output		
CPU modules					
FX5U-32MR/ES	100 to 240 V AC 50/60 Hz	16 points	24 V DC Sink/source	16 points	Relay
FX5U-32MT/ES				Transistor/sink	
FX5U-32MT/ESS		Transistor/source			
FX5U-64MR/ES		32 points		32 points	Relay
FX5U-64MT/ES					Transistor/sink
FX5U-64MT/ESS		Transistor/source			
FX5U-80MR/ES	40 points	40 points	Relay		
FX5U-80MT/ES			Transistor/sink		
FX5U-80MT/ESS	Transistor/source				
FX5UC-32MT/D	24 V DC	16 points	24 V DC Sink	16 points	Transistor/sink
FX5UC-32MT/DSS		24 V DC Sink/source	Transistor/source		
I/O modules					
FX5-8EX/ES	Power supply from CPU module	8 points	24 V DC Sink/source	—	—
FX5-16EX/ES		16 points			
FX5-8EYR/ES		—	—	8 points	Relay
FX5-8EYT/ES					Transistor/sink
FX5-8EYT/ESS		Transistor/source			
FX5-16EYR/ES		—	—	16 points	Relay
FX5-16EYT/ES	Transistor/sink				
FX5-16EYT/ESS	Transistor/source				
FX5-32ER/ES	100 to 240 V AC 50/60 Hz	16 points	24 V DC Sink/source	16 points	Relay
FX5-32ET/ES					Transistor/sink
FX5-32ET/ESS					Transistor/source
FX5-C32EX/D	Power supply from CPU module	32 points	24 V DC Sink	—	—
FX5-C32EX/DS			24 V DC Sink/source		—
FX5-C32EYT/D		—	—	32 points	Transistor/sink
FX5-C32EYT/DSS					Transistor/source
FX5-C32ET/D		16 points	24 V DC Sink	16 points	Transistor/sink
FX5-C32ET/DSS					24 V DC Sink/source

Expansion Boards & Adapters

Model	Specification
FX5-232-BD	For RS-232C communication
FX5-485-BD	For RS-485 communication
FX5-422-BD-GOT	For GOT RS-422 communication
FX5-232ADP	For RS-232C communication
FX5-485ADP	For RS-485 communication
FX5-4AD-ADP	4 ch analog input adapter
FX5-4DA-ADP	4 ch analog output adapter

Intelligent function modules

Model	Specification
FX5-40SSC-S	Simple Motion 4-Axis module
FX3U-4AD	4 ch analog input
FX3U-4DA	4 ch analog output
FX3U-4LC	4 ch temperature control
FX3U-1PG	Positioning pulse output 200 kHz
FX3U-2HC	2 ch 200 kHz high-speed counter
FX3U-16CCL-M	Master for CC-Link (compatible with Ver. 2.00)
FX3U-64CCL	Interface for CC-Link (compatible with Ver. 2.00)

Power supply modules & Bus/Connector conversion modules

Model	Specification
FX5-1PSU-5V	Extension power supply module
FX5-CNV-BUS	Bus conversion FX5(terminal block)→FX3(terminal block)
FX5-CNV-BUSC	Bus conversion FX5(connector)→FX3(terminal block)
FX5-CNV-IFC	Connector conversion FX5(connector)→FX5(terminal block)
FX3U-1PSU-5V	FX3U Extension power supply module

Software

Type	Model	Specification
MELSOFT iQ Works (DVD-ROM)	SW2DND-IQWK-E	FA engineering software*1
MELSOFT GX Works3 (DVD-ROM)	SW1DND-GXWK3-E	PLC engineering software (includes GX Works2, GX Developer)

*1: Refer to the manual of the software for supported models.

User's manuals for the applicable modules

Manual name <manual number>	Description
MELSEC iQ-F FX5 User's Manual (Startup) <JY997D58201>	Describes the performance specifications, procedures before operation, and troubleshooting of the CPU module.
MELSEC iQ-F FX5UC User's Manual (Hardware) <JY997D61401>	Describes the details on the hardware of the FX5UC CPU module, including input/output specifications, wiring, installation and maintenance.
MELSEC iQ-F FX5U User's Manual (Hardware) <JY997D55301>	Describes the details on hardware of the FX5U series CPU module, including input/output specifications, wiring, installation, and maintenance.
MELSEC iQ-F FX5 User's Manual (Application) <JY997D55401>	Describes basic knowledge required for program design, functions of the CPU module, devices/labels, and parameters.
MELSEC iQ-F FX5 Programming Manual (Program Design) <JY997D55701>	Describes specifications of ladder, ST, and other programs and of labels.
MELSEC iQ-F FX5 Programming Manual (Instructions, Standard Functions/Function Blocks) <JY997D55801>	Describes specifications of instructions and functions that can be used in programs.
MELSEC iQ-F FX5 User's Manual (Serial Communication) <JY997D55901>	Describes inverter communication, and non-protocol communication.
MELSEC iQ-F FX5 User's Manual (SLMP) <JY997D56001>	Describes SLMP communication.
MELSEC iQ-F FX5 User's Manual (MELSEC Communication Protocol) <JY997D60801>	Describes MC protocol.
MELSEC iQ-F FX5 User's Manual (MODBUS Communication) <JY997D56101>	Describes MODBUS serial communication.
MELSEC iQ-F FX5 User's Manual (Ethernet Communication) <JY997D56201>	Describes the functions of the built-in Ethernet port communication function.
MELSEC iQ-F FX5 User's Manual (Positioning Control) <JY997D56301>	Describes the built-in positioning function.
MELSEC iQ-F FX5 User's Manual (Analog Control) <JY997D60501>	Describes the analog function.

About this product catalog

Due to the constantly growing product range and new or changed product features, the information in this catalog may be updated without notice. Please contact your Mitsubishi Electric product provider for more details.

Texts, figures and diagrams shown in this product catalog are intended exclusively for explanation and assistance in planning and ordering the FX5 programmable logic controllers (PLCs) and the associated accessories. Only the manuals supplied with the units are relevant for installation, commissioning and handling of the units and the accessories. The information given in the manuals must be read before installation and commissioning of the units or software.

If any questions arise regarding the application or use of the PLC units and accessories described in this catalog, please contact your Mitsubishi Electric product provider.

This catalog confers no industrial property rights or any rights of any other kind, nor does it confer any patent licenses. Mitsubishi Electric Corporation cannot be held responsible for any problems involving industrial property rights which may occur as a result of using the contents noted in this catalog.

©2015 MITSUBISHI ELECTRIC CORPORATION

- Microsoft and Windows are trademarks or registered trademarks of Microsoft Corporation in the United States and other countries.
- Ethernet is a trademark of Xerox Corporation.
- MODBUS is a registered trademark of Schneider Electric SA.
- The SD and SDHC logos are trademarks or registered trademarks of SD 3C, LLC.
- All other company names and product names used in this document are trademarks or registered trademarks of their respective companies.

Truy cập website <https://plcmitsubishi.com> để có thêm nhiều tài liệu và bài viết hướng dẫn kỹ thuật hay

PROGRAMMABLE CONTROLLERS

Truy cập Website <http://plc.mitsubishi.com> để có thêm nhiều tài liệu và bài viết hướng dẫn kỹ thuật hay

MITSUBISHI ELECTRIC CORPORATION

HEAD OFFICE: TOKYO BLDG., 2-7-3, MARUNOUCHI, CHIYODA-KU, TOKYO 100-8310, JAPAN
<http://Global.MitsubishiElectric.com>